

SIEMENS

SIMODRIVE 611 analog

Start-Up Guide

10.2000 Edition

Transistor PWM Inverters for AC Feed Drives and AC Main Spindle Drives

Overview of Documentation for SIMODRIVE 611 analog

General Documentation



Catalog
Order Document NC 60



Catalog
Accessories and
Equipment for Special-
Purpose Machines
Order Document NC Z

Manufacturer/Service Documentation

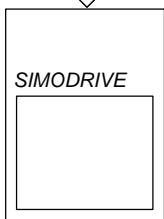

Planning Guide
Motors
AC Motors for
Feed and Main
Spindle Drives

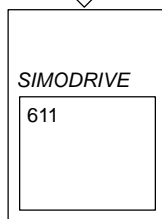

Planning Guide
Transistor PWM
Inverters for AC Feed
Drives and AC Main
Spindle Drives



EMC Guidelines
for SINUMERIK
and SIROTEC
Controls

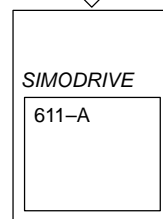

Description
SIMODRIVE 611 analog
Start-up Software for
Main Spindle and
Induction Motor Modules

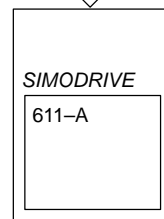

Start-up Guide
SIMODRIVE 611 analog
Transistor PWM
Inverters for AC Feed
Drives and AC Main
Spindle Drives

Electronic Documentation

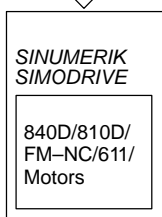

DOC ON CD
The SINUMERIK System

SIEMENS

SIMODRIVE 611 analog

Transistor PWM Inverters for AC Feed Drives and AC Main Spindle Drives

Start-Up Guide

Valid for

Equipment series 6SN11–

10.00 Edition

Foreword

General Information **AL**

Supply Infeed **NE**

Feed Modules **VS**

Feed Modules,
Resolver Control **VR**

Main Spindle Modules **HS**

Induction Motor Modules **AM**

Spare Parts **ES**

Attachment **A**

Short reference NE/VS

Short reference VR

Short reference HS

Short reference AM

Overall Index

SIMODRIVE® documentation

Edition coding

Brief details of the Edition and previous editions are listed below.

The status of each Edition is shown by the code in the "Remarks" column.
Status code in the "Remarks" column:

- A** New documentation.
- B** Unrevised reprint with new Order No.
- C** Revised edition with new status.

If factual changes have been made on the page since the last edition, this is indicated by a new Edition coding in the header on that page.

Edition	Order No.	Remarks
07.94	6SN1197-0AA60-0BP0	A
10.94	6SN1197-0AA60-0BP1	C
12.94	6SN1197-0AA60-0BP2	C
03.96	6SN1197-0AA60-0BP3	C
04.97	6SN1197-0AA60-0BP4	C
10.00	6SN1197-0AA60-0BP5	C

This Manual is also included in the documentation on CD-ROM (**DOCONCD**)

Edition	Order No.	Remarks
10.00	6FC5298-6CA00-0BG0	C

Trademarks

SIMATIC®, SIMATIC HMI®, SIMATIC NET®, SIROTEC®, SINUMERIK® and SIMODRIVE® are registered trademarks of Siemens. Other names in this publication might be trademarks whose use by a third party for his own purposes may violate the rights of the registered holder.

You will find additional information in the Internet under:
<http://www.ad.siemens.de/simodrive>

This document was generated with Interleaf V 7

The reproduction, transmission or use of this document or its contents is not permitted without express written authority. Offenders will be liable for damages. All rights, including rights created by patent grant or registration of a utility model or design, are reserved.

© Siemens AG 2000. All rights reserved.

Functions may be executable in the control but are not described in this documentation. No claims can be made on these functions if included with a new shipment or when involved with service.

We have checked the contents of this document to ensure that they coincide with the described hardware and software. The information in this document is regularly checked and necessary corrections are included in reprints. We are thankful for any recommendations for improvement.

Subject to change without prior notice.

Foreword

This document is part of the documentation developed for SIMODRIVE. All documents are available individually.

The documentation list, which includes all advertising Brochures, Catalogs, Overviews, Short Descriptions, User Manuals and Technical Descriptions can be obtained from your local Siemens office with Order No., location and price.

This Manual does not purport to cover all details or variations in equipment, nor to provide for every possible contingency to be met in connection with installation, operation or maintenance.

Should further information be desired or should particular problems arise, which are not covered sufficiently for the purchaser's purposes, the matter should be referred to the local Siemens sales office.

The contents of this Guide shall not become part of nor modify any prior or existing agreement, commitment or relationship.

The sales contract contains the entire obligation of Siemens. Any statements contained herein neither create new warranties nor modify the existing warranty.

Definitions

Qualified personnel

For the purpose of this documentation and product labels, a “qualified person” is someone who is familiar with the installation, mounting, start-up and operation of the equipment and the hazards involved. He or she must have the following qualifications:

- Trained and authorized to energize, de-energize, clear, ground and tag circuits and equipment in accordance with established safety procedures.
- Trained in the proper care and use of protective equipment in accordance with established safety procedures.
- Trained in rendering first aid



Danger

This symbol indicates that death, severe personal injury or substantial property damage **will** result if proper precautions are not taken.



Warning

This symbol indicates that death, severe personal injury or property damage **can** result if proper precautions are not taken.



Caution

This warning (with warning triangle) indicates that minor personal injury **can** result if proper precautions are not taken.

Caution

This warning (without warning triangle) indicates that material damage **can** result if proper precautions are not taken.

Notice

This warning indicates that an undesirable situation or condition **can** occur if the appropriate instructions/information are not observed.



Important

This symbol appears in the documentation if a particular issue is significant.

Note

For the purpose of this documentation, "Note" indicates information about the product or the respective part of the document which is essential to highlight.



Warning

Operational electrical equipment has parts and components which are at hazardous voltage levels.

Incorrect handling of these units, i.e. not observing the warning information, can therefore lead to death, severe bodily injury or significant material damage.

Only appropriately qualified personnel may commission/start-up this equipment.

This personnel must have in-depth knowledge regarding all of the warning information and service measures according to this Guide.

Perfect, safe and reliable operation of this equipment assumes that it has been professionally transported, stored, mounted and installed as well as careful operator control and service.

Hazardous axis motion can occur when working with the equipment.

Note

When handling cables, observe the following

- they must not be damaged,
 - they must not be strained and
 - they must not come into contact with rotating components.
-

Note

It is not permissible to connect SIMODRIVE equipment to a supply system with ELCBs (this restriction is permitted acc. to DIN VDE 0160 / 05.88, Section 6.5). When operational, protection against direct contact is provided in a form to allow the unit to be used in enclosed electrical equipment rooms (DIN VDE 0558 Part 1 / 07.87, Section 5.4.3.2.4)

In compliance with DIN VDE 0160 / 05.88, all SIMODRIVE units are subject to a high-voltage test at the time of routine testing. If the electrical equipment of industrial tools is subject to a high-voltage test, all connections must be disconnected so that sensitive electronic components in the SIMODRIVE converter are not damaged (permissible acc. to DIN VDE 0113 / 06.93, Part 1, Section 20.4).



Warning

Start-up/commissioning is absolutely prohibited until it has been ensured that the machine in which the components described here are to be installed, fulfills the regulations/specifications of the Directive 89/392/EWG.



Warning

The information and instructions in all of the documentation supplied and any other instructions must always be observed to eliminate hazardous situations and damage.

- For special versions of the machines and equipment, the information in the associated catalogs and quotations applies.
 - Further, all of the relevant national, local and plant/system-specific regulations and specifications must be taken into account.
 - All work should be undertaken with the system in a no-voltage condition!
-



Warning

Before commissioning SIMODRIVE 611 analog it should be checked that the encoder cable does not have a ground fault. If ground faults occur for loads which exert a force on the drive (e.g. hanging, vertical axes), uncontrolled movement could occur. This no longer occurs for 6SN1118-0D□2□-0AA0, Version B.

ESDS information**Electro-static discharge sensitive devices**

Components which can be destroyed by electrostatic discharge are individual components, integrated circuits, or boards, which when handled, tested or transported, could be destroyed by electrostatic fields or electrostatic discharge. These components are designated as **ESDS (ElectroStatic Discharge Sensitive Devices)**.

Handling ESDS boards:

- The human body, working area and packing should be well grounded when handling ESDS components!
- Electronic boards should only be touched when absolutely necessary.
- Components may only be touched, if
 - you are continuously grounded through an ESDS bracelet,
 - you are wearing ESDS shoes or ESDS shoe grounding strips in conjunction with an ESDS floor surface.
- Boards may only be placed on conductive surfaces (desk with ESDS surface, conductive ESDS foam rubber, ESDS packing bag, ESDS transport containers).
- Boards may not be brought close to data terminals, monitors or television sets (a minimum of 10 cm should be kept between the board and the screen).
- Boards may not be brought into contact with materials which can be charged-up and which are highly insulating, e.g. plastic foils, insulating desktops, articles of clothing manufactured from man-made fibers.
- Measuring work may only be carried out on the boards, if
 - the measuring equipment is grounded (e.g. via the protective conductor) or
 - for floating measuring equipment, the probe is briefly discharged before making measurements (e.g. a bare control housing is touched).
- Only touch the control boards at the front panel

Note

Start-up software is available for starting-up/commissioning the main spindle and induction motor modules.

Start-up software Order No.: 6SN1153-2AX10-□AB□

Documentation Order No.: 6SN1197-0AA30-0□P□

SINUMERIK and SIMODRIVE

Enhanced productivity as a result of fast, reliable commissioning

Handling

Sophisticated industrial electronics, as are involved here, have to be handled especially carefully. We regularly evaluate and investigate equipment which is returned, and in so doing, we have identified some of the main fault causes, which in some cases results from incorrect handling during commissioning and troubleshooting.

Check list

The following check list should help you to simply commission the components we have supplied and guarantee a high availability when used in conjunction with your product or equipment.

- Observe all of the ESD measures when handling components.
 - Tighten-up all bolts and screws to the specified torque. Pay special attention to the DC link bolt connections (1.8 Nm tightening torque).
 - Correctly insert all connectors and lock/screw into place.
 - Screw the control components into the power module.
 - Observe the power-on sequence in the Planning Guide.
- If the unit is frequently powered-down and up, the DC link charge circuit is locked-out. The DC link can only be charged again after it has cooled down for several minutes with the supply off.
- Are there line supply/motor contactors connected to the drive converter? These are only switched in a no-current condition.
 - Ground all components and connect all of the shields. Connection X131 is grounded.
 - Observe the load capability of the central power supply.
 - Only discharge the unit at the DC link buses through a minimum of 10 Ω .
 - In operation, units with hard disks may only be stressed with a max. of 1 g read/write error; defective).
 - Are OEM components (ISA-/PCMCIA card) used? Their current drain must lie within the specified values.
 - CRT monitors may not be subject to magnetic fields (e.g. power supply unit coils).
 - When commissioning and fault finding, always proceed in a modular step-by-step fashion. This means: First commission the central controller and line supply module, then connect-up and commission the components one after another.

- The units are designed for the specified mechanical, climatic and electrical ambient conditions. None of the limit values may be exceeded, neither in operation nor during transport. Please pay specific attention to the following:
 - line supply conditions
 - pollutants
 - damaging gases
 - climatic ambient conditions
 - storage/transport
 - shock stressing
 - vibration stressing
 - ambient temperature

**Further
information**

Further detailed information is provided in the Planning Guides and Installation Start-up Guides associated with our products.



General Information (AL)

1 **Permissible Combination of Power Modules and Control Boards** **AL/1-3**

1 Permissible Combination of Power Modules and Control Boards

AL

Permissible Combination of Power Modules and Control Boards

1

Table 1-1

Selection list to set the current controller referred to the resulting power module currents

SIMODRIVE 611 components	FD control, analog 1-axis, user-friendly interface 6SN1118-0AA11-0AA □	FD control, analog 1-axis, standard interface 6SN1118-0AD11-0AA□	FD control, analog 2-axis, standard interface 6SN1118-0AE11-0AA□	FD resolver control, analog 1-axis, standard interface 6SN1118-0BJ11-0AA0	FD resolver control, analog 2-axis, standard interface 6SN1118-0BK11-0AA0	MSD control, analog No direct measuring system 6SN1121-0BA11-0AA0	MSD control, analog Dir. meas. system, TTL signal 6SN1121-0BA12-0AA0	MSD control, analog Ext. position output 6SN1121-0BA13-0AA0	IM control, analog Fixed setpoints, motorized pot 6SN1122-0BA11-0AA0	IM control, analog Anal. speed f. setp. mot. pot. 6SN1122-0BA12-0AA0	MSD control, analog 6SN1121-0BA11-0AA1	IM control, analog 6SN1122-0BA11-0AA1
Parameter board FD analog user-friendly 6SN114-0AA01-0AA0	Required	—	—	—	—	—	—	—	—	—	—	—
HS option FD analog user-friendly 6SN114-0AA02-0AA□	Possible	—	—	—	—	—	—	—	—	—	—	—
Power module, 8A 6SN12□-1AA0□-0HA□	FD: 4/8A	FD: 4/8A	—	FD-R: 3/6A	—	—	—	—	IM: 3/3.3 A	IM: 3/3.3 A	—	IM: 3/3.3 A
Power module, 15A 6SN12□-1AA0□-0AA□	FD: 7.5/15A	FD: 7.5/15A	—	FD-R: 5/10A	—	—	—	—	IM: 3/3.8 A	IM: 5/5/8 A	—	IM: 3/3.8 A
Power module, 25A 6SN12□-1AA0□-0BA□	FD: 12.5/25A	FD: 12.5/25A	—	FD-R: 9/18A	—	—	—	—	IM: 8/10/16A	IM: 8/10/16A	—	IM: 8/10/16A
Power module, 50A 6SN12□-1AA0□-0CA□	FD: 25/50A	FD: 25/50A	—	FD-R: 18/36A	—	MSD: 24/32/32A	MSD: 24/32/32A	MSD: 24/32/32A	IM: 24/32/32A	IM: 24/32/32A	MSD: 24/32/32A	IM: 24/32/32A
Power module, 80A 6SN12□-1AA0□-0DA□	FD: 40/80A	FD: 40/80A	—	FD-R: 28/56A	—	MSD: 30/40/51A	MSD: 30/40/51A	MSD: 30/40/51A	IM: 30/40/51A	IM: 30/40/51A	MSD: 30/40/51A	IM: 30/40/51A
Power module, 120A 6SN12□-1AA0□-0GA□	—	—	—	—	—	MSD: 45/60/76A	MSD: 45/60/76A	MSD: 45/60/76A	IM: 45/60/76A	IM: 45/60/76A	MSD: 45/60/76A	IM: 45/60/76A
Power module, 108A 6SN12□-1AA0□-0LA□	—	—	—	—	—	MSD: 45/60/76A	MSD: 45/60/76A	MSD: 45/60/76A	IM: 45/60/76A	IM: 45/60/76A	MSD: 45/60/76A	IM: 45/60/76A
Power module, 160A 6SN12□-1AA0□-0EA□	FD: 80/160A	FD: 80/160A	—	—	—	MSD: 60/80/ 102A	MSD: 60/80/ 102A	MSD: 60/80/ 102A	IM: 60/80/ 102A	IM: 60/80/ 102A	MSD: 60/80/ 102A	IM: 60/80/ 102A
Power module, 200A 6SN12□-1AA0□-0FA□	FD: 100/200A	FD: 100/200A	—	—	—	MSD: 85/110/ 127A	MSD: 85/110/ 127A	MSD: 85/110/ 127A	IM: 85/110/ 127A	IM: 85/110/ 127A	MSD: 85/110/ 127A	IM: 85/110/ 127A
Power module, 200A pipe connection 6SN12□-1AA0□-0FA□	FD: 100/200A	FD: 100/200A	—	—	—	MSD: 85/110/ 127A	MSD: 85/110/ 127A	MSD: 85/110/ 127A	IM: 85/110/ 127A	IM: 85/110/ 127A	MSD: 85/110/ 127A	IM: 85/110/ 127A

Note

This document describes the steps which are necessary to start-up (commission) an installed SIMODRIVE drive group. Please refer to the associated Planning Guides for additional technical information, e.g. regarding

- ambient conditions
- recommended circuits
- connection diagrams
- dimension sheets/dimension drawings

SIMODRIVE 611

Transistor PWM Inverters for AC Feed Drives and AC Main Spindle Drives

Order No.: 6SN1197-0AA00-0□P□

SIMODRIVE

AC Motors for Feed and Main Spindle Drives

Order No.: 6SN1197-0AA20-0□P□



Supply Infeed (NE)

1	Standard Settings, NE Modules (UE and I/R Modules), Monitoring and Pulsed Resistor Modules	NE/1-3
2	Service and Diagnostics	NE/2-7
2.1	Terminals and relay functions	NE/2-8
3	Attachment	NE/3-13
3.1	Terminals, NE, monitoring and pulsed resistor modules	NE/3-14
3.2	Terminals, UE module 5/10 kW	NE/3-16

Standard Settings, NE Modules (UE and I/R Modules), Monitoring and Pulsed Resistor Modules

NE

1



Important

Observe the information/instructions regarding closed-loop sinusoidal current control for I/R modules!

If you do not observe the difference between sinusoidal/squarewave current control, the equipment could be destroyed!

There is a switch S1 on the upper side of the NE and monitoring module which is used to select the following functions:

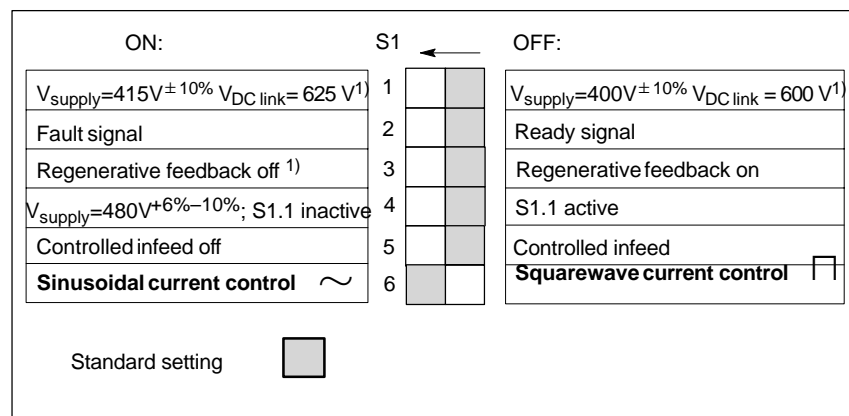

Fig. 1-1 DIL switch S1



Important

For I/R modules. Order No. 6SN114□-1□□0□-0□□1 the basic setting is closed-loop sinusoidal control . Observe the information on NE/1-5!



Important

Before the system is powered-up/down using the main switch or a line contactor, terminal 63 (pulse enable) and/or terminal 48 (start terminal, contactor control), must be de-energized or disconnected!

1) only possible for I/R module, monitoring thresholds are increased for all NE modules

- Switch S 1.1 :**
- OFF: I/R module $V_{\text{supply}} = 400V \pm 10\%$;
 $V_{\text{DC link}} = 600V$ (DC link voltage)
 UE module $V_{\text{supply}} = 400V \pm 10\%$; $V_{\text{DC link}} = 1.35 \cdot V_{\text{supply}}$
 Monitoring thresholds: (I/R, UE, monitoring modules)
 Pulsed resistor on = 644V (pulsed res. switch-on threshold);
 Pulsed resistor off = 618V (pulsed res. switch-off threshold)
 $V_{\text{DC link}} >> = 710V$ (DC link overvoltage threshold);
- ON: I/R module $V_{\text{supply}} = 415V \pm 10\%$; $V_{\text{DC link}} = 625V$
 UE module $V_{\text{supply}} = 415V \pm 10\%$; $V_{\text{DC link}} = 1.35 \cdot V_{\text{supply}}$
 Monitoring thresholds: (I/R, UE, monitoring modules)
 Pulsed resistor on = 670V; Pulsed resistor off = 640V
 $V_{\text{DC link}} >> = 740V$;
- Comment: Only active, if S1.4 OFF
- Switch S 1.2 :**
- OFF: Ready signal (X111: Ready relay)
- ON: Fault signal (X111: Ready relay)
- refer to NE/Section 2.1
- Switch S 1.3 :**
- OFF: Standard setting, regenerative feedback active
 I/R modules are capable of regenerating into the line supply
 UE module: The pulsed resistor in the module is effective
- ON: Regenerative feedback is disabled
 I/R module: Regenerative feedback operation is inhibited
 UE module: The pulsed resistor in the module is not effective
- Comment: The function is only effective for UE 10kW from
 Order No.[MLFB]: 6SN1146-1AC00-0AA1 onwards
 (not for UE 28kW)
- Switch S 1.4 :**
- OFF: S1.1 active
- ON: $V_{\text{supply}} = 480V + 6\% - 10\%$; $V_{\text{DC link}} = 1.35 \cdot V_{\text{supply}}$ in the
 regenerative feedback direction
 Monitoring thresholds: (I/R, UE, monitoring modules)
 Pulsed resistor on = 744V; Pulsed resistor off = 718V
 $V_{\text{DC link}} >> = 795V$
- Comment: Uncontrolled operation in the regenerative feedback direction.
 (valid for Order No. [MLFB] 6SN114□-1□□0□-0□□1)

Note

Only in conjunction with power modules, Order No. [MLFB]
 (6SN114□-1□□0□-0□□1).
 For motors with shaft heights < 100 mm: Utilized up to max. the 60 K values.
 Please observe the Planning Guide, Motors.
 S1.4 ON overwrites the functions of S1.5 and S1.1.

1 Standard Settings NE Modules, Monitoring and Pulsed Resistor Modules

Switch S 1.5 : This function is only available in conjunction with I/R modules
 Order No.: 6SN114□-1□□0□-0□□1
 OFF: Standard setting, controlled infeed active.
 ON: Uncontrolled operation in the regenerative feedback direction
 $V_{DC \text{ link}} = 1.35 \cdot V_{\text{supply}}$.
 Regenerative feedback starts at $V_{DC \text{ link}} = 600$ or $625V$, depending on the setting of S1.1.

Switch S 1.6 : OFF: Closed-loop squarewave current control (current square waveform is drawn from the line supply)
 ON: (Standard) This function is only available in conjunction with I/R modules 6SN114□-1□□0□-0□□1 closed-loop sinusoidal current control (sinusoidal current is drawn from the line supply)

Sinusoidal current is only permissible if the following secondary conditions are fulfilled:

I/R 16 kW	I/R 36 kW	I/R 55 kW	I/R 80 kW	I/R 120 kW
6SN114□- 1B□01-0BA1	6SN114□- 1B□02-0CA1	6SN114□- 1B□0□-0DA1	6SN114□- 1BB00-0EA1	6SN114□- 1BB01-0FA1
HF reactor 16 kW	HF reactor 36 kW	HF reactor 55 kW	HF reactor 80kW	HF reactor 120kW
6SN1111- 0AA00-0BA0	6SN1111- 0AA00-0CA0	6SN1111- 0AA00-0DA0	6SN1111- 0AA00-1EA0	6SN1111- 0AA00-1FA0
Line filter sinusoidal current ¹⁾ 16 kW	Line filter for sinusoidal current ¹⁾ 36 kW	Line filter for sinusoidal current ¹⁾ 55 kW	Line filter for sinusoidal current ¹⁾ 80 kW	Line filter for sinusoidal current ¹⁾ 120 kW
6SN1111- 0AA01-2BA0	6SN1111- 0AA01-2CA0	6SN1111- 0AA01-2DA0	6SN1111- 0AA01-2EA0	6SN1111- 0AA01-2FA0

**Important**







For all combinations which are not listed, only closed-loop squarewave current control is permissible .

1) In the sinusoidal line filters, contrary to the squarewave current filter modules, there are no HF commutating reactors. The HF commutating reactor must be separately mounted. The specified line filter types are also suitable for the squarewave current mode.

Service and Diagnostics

2

Display elements on the monitoring and NE modules

1			2
3			4
5			6

1	LED red	– Electronics power supply ± 15 V faulted
2	LED red	– 5 V voltage level faulted
3	LED green	– Ext. enable signal not available (terminal 63 and/or 64 missing)
4	LED yellow	– DC link charged
5	LED red	– Line supply fault (single or multi-phase line supply failure at terminals U1, V1, W1) ¹⁾ – No commutating reactor, incorrectly installed or incorrectly selected – Fault level of the line supply or transformer too low
6	LED red	– DC link overvoltage Possible causes: Regenerative feedback off, setting-up operation, line supply fault, for UE, pulsed resistor not operational or too small, line supply voltage too high, dynamic overload, line supply filter installed between the I/R and commutating reactor

Effects:

- 1 LED red bright: Pulses are deleted for the complete drive group
- 2 LED red bright: Pulses are deleted for the complete drive group
- 4 LED yellow dark: Pulses are deleted for the complete drive group
- 5 LED red bright: Only the I/O module pulses are deleted (regenerative feed back no longer possible. Axes initially continue to run, ready relay drops-out)
- 6 LED red bright: Pulses are deleted for the complete drive group

1) Line supply fault recognition time, approx. 30 ms
Line supply fault is recognized when the three-phase voltage is < 280 V.
For a single-phase power failure, the drive axis pulses are deleted after approx. 1 min (saved signal) valid for Order No. [MLFB] 6SN1114□-1□□0□-0□□1

2.1 Terminals and relay functions

- **X111 Ready relay**

– terminals 72 – 73.1	NO contacts	closed for “ready”
– terminals 73.2 – 74	NC contacts	open for “ready”

Switch S1.2 OFF, the relay pulls-in, if:

- internal main contactor CLOSED (terminals NS1 – NS2 connected, terminal 48 energized)
- terminal 63, 64 = ON
- it is not permissible that a fault is present
(this is also true for FD 611A Standard, 611D drives or MCU)
- FD with standard interface or resolver for the “ready” setting must be enabled (terminals 663, 65)
- NCU must have run-up (SINUMERIK 840D, SINUMERIK 810D)
- the MCU must have run-up

Switch S1.2 ON, relay pulls-in, if:

- internal main contactor CLOSED (terminal NS1 – NS2 connected, terminal 48 energized)
- it is not permissible that a fault is present
(this is also true for FD 611A Standard, or 611D drives or MCU)
- FD with standard interface or resolver for the “ready” setting must be enabled (terminals 663, 65)
- NCU must have run-up (SINUMERIK 840D, SINUMERIK 810D)
- the MCU must have run-up

- **X121 I²t pre-alarm and motor overtemperature**

Terminals 5.1 – 5.2	NO contacts	open for “no fault”
Terminals 5.1 – 5.3	NC contacts	closed for “no fault”

This relay switches, if:

- at the I/R → the heatsink temperature monitoring responds
- at FD 611D → the motor temperature monitoring responds
- heatsink temperature monitoring responds
- at FD 611A user-friendly
 - motor-temperature monitoring responds
(for resolvers: this is not saved, no shutdown!!)
 - heatsink temperature monitoring responds
 - I²t pre-alarm responds (this is not saved)
- at FD611A Standard
 - motor-temperature monitoring responds
 - heatsink temperature monitoring responds
 - I²t temperature monitoring responds

- **X171 terminals NS1 – NS2
(coil circuit of the internal line supply and pre-charging contactor)**

- is used to provide electrical isolation from the line supply
(signaling contact, terminals 111 – 213 must be interrogated)
- may only be switched when terminal 48 is open-circuit
(without any restrictions from
Order No. [MLFB] 6SN1145-1□□01-0□□□ for 10, 16 and 55 kW
Order No. [MLFB] 6SN1145-1□□02-0□□□ for 36 kW, all 80 and 120 kW)

- **Terminal 48** **Start**
 - has the highest priority
 - sequence:
 - pre-charging ON – interrogate $V_{DC\ link} \geq 300V$ and $V_{DC\ link} \geq \sqrt{2} \cdot V_{supply}$
 - 50 V.
 - If yes, then
 - 500 ms pre-charging contactor OPEN, interrogate whether actually OPEN, main contactor CLOSE
 - 1 s internal enable signal (for I/R and module group)
 - is saved during pre-charging
- **Terminal 63** **Pulse enable**
 - has the highest priority for enabling the pulses for all of the modules
 - acts instantaneously
- **Terminal 64** **Drive enable**
 - acts instantaneously on all modules
 - when the signal is withdrawn, n_{set} is set to 0 for all drives, and
 - For MSD / IM 611A, after a selectable speed has fallen below, the pulses are cancelled. The drive is braked along a ramp.
 - For VSA 611A, all of the controllers and pulses are inhibited after a selected time has expired (setting when supplied: 240 ms). The drive is braked along the current limit.
 - For 611D drives, the pulses are deleted after a selectable speed has been fallen below or after a selectable time has expired. The drive is braked at the selected limit! (for spindles, the ramp can only be achieved along the regenerative limit [kW]!)
- **Terminal 112 open-circuit** **Setting-up operation**
 - The $V_{DC\ link}$ control is inhibited
 - Regenerative feedback is not possible, i.e. when braking, $V_{DC\ link}$ can be > 600 V !
 - This function can be interrogated using the start inhibit signal, terminals AS1 – AS2.



Caution

Induction motors can reach high speeds even at low $V_{DC\ link}$!

- **Terminals AS1 – AS2** **Start inhibit signal**
 - Terminals AS1 – AS2 closed means “start inhibit is effective” (i.e. terminal 48 = open-circuit, setting-up operation)
- **Terminals 111, 113, 213** **Signaling contacts, internal line contactor**
 - Terminals 111 – 113 NO contacts
 - Terminals 111 – 213 NC contacts (for I/R 16 kW and UE 10 kW, only from Order No.[MLFB] 6SN1145-1□□01-0□□□)

2.1 Terminals and relay functions

- **Terminal 19** **FR–**
 - Reference ground, enable voltage
 - Floating (connected with the general reference ground terminal 15 via 10 kΩ)
 - Terminal 19 may not be connected to terminal 15 (connect to PE rail, or to X131)
- **Terminal 9** **FR+**
 - Enable voltage : +24 V
 - Maximum load capacity of the power supply (power supply): 500 mA
(corr. to 8 EP; 1 optocoupler input required 12 mA, for UE = 5 kW → 1A)
- **X 141** **Electronic voltages**

– Term. 7	P24	+20.4 to 28.8 V / 50 mA
– Term. 45	P15	+15 V / 10 mA
– Term. 44	N15	–15 V / 10 mA
– Term. 10	N24	–20.4 to –28.8 V / 50 mA
– Term. 15	M	0 V

 - Terminal 15 may not be connected to PE (ground loop)
 - Terminal 15 may not be connected to terminal 19 (short-circuit via reactor, which internally connects terminal 15 to X131)
- **Terminals L1 – L2 for 80 kW and 120 kW I/R**
 - Is used to supply the coil circuit of the internal line contactor
 - directly supplied with 2-ph. 400 V AC at the line supply (not between I/R and reactor)
 - Fuse: $I_N \geq 4$ A, version gL
- **Fan connection for 80 and 120 kW I/R**
 - 3-ph. 360 to 510 V AC, 45 – 65 Hz directly from the line supply (not between I/R and reactor)
 - Observe the direction of rotation!
 - Fuse: $I_N > 1.5$ A (motor protection circuit-breaker)
- **6-wire connection with additional power supply connection at the DC link:**
 - For this mode, terminals 2U1, 2V1 and 2W1 of the power supply **must** be supplied with the line supply voltage **between** the series reactor and I/R, as otherwise the power supply will be destroyed. The also applies to the monitoring modules!

Note

This is guaranteed by the jumpers inserted in the factory at connector X181.

- **Monitoring module with connection to the line supply and additional power supply connection at the DC link :**
 - For this mode, terminals 2U1, 2V1 and 2W1 of the power supply **must** be supplied with the line supply voltage between the series reactor and I/R, as otherwise, the power supply will be destroyed!
 - Terminal 63 may only be energized (enabled) after the NE module has run-up (ready). (Interrogation “ready” or terminal 111 – 113 – 213).

Diagnostics

The overvoltage limiting module must be checked if a line supply fault is displayed or the yellow LED is dark.

Procedure:

1. Power-down the unit so that it is in a no-voltage condition
2. Remove the overvoltage limiting module and insert connector X181 on the NE module. If the NE module functions, then the overvoltage limiting module is defective and must be replaced. Otherwise, check the line supply and if necessary check the NE module/group.

Note

In this way, continued operation is possible, **without overvoltage protection**.

3. Insert the overvoltage limiting module 566018.9415.00 up to its end stop, and insert connector X181 on the overvoltage limiting module.

Note

Operation without overvoltage limiting module is not in conformance with UL!



Attachment

3

NE

Note

When using non PELV circuits at terminals AS1, AS2, terminal 111, terminal 113 and terminal 213, connector coding must be used to prevent connectors being interchanged.

—> refer to EN 60204–1, Section 6.4.

Order No. for the coding connector —> refer to Catalog NC 60.1.

Only PELV circuits may be connected to terminal 19.

3.1 Terminals, NE, monitoring and pulsed resistor modules

Table 3-1 Terminal functions

Term. No.	Desig.	Function	Type 1)	Typ. voltage/limit values	Max. cross-section	Terminals available in 3)	
U1 V1 W1		Line supply	I	3-ph. 400 V/480 V AC	Refer to the Planning Guide	I/R, UE	
L1 L2		Line supply for contactor	I I	2-ph. 400 V AC, directly at the line supply	16mm ² /10mm ² 4) 16mm ² /10mm ² 4)	I/R 80/104 kW, 120/156 kW	
PE P600 M600		Protective conductor DC link DC link	I I/O I/O	0 V +300 V -300 V	Bolt Busbar Busbar	I/R, UE, MM, PR	
		Grounding bar 5)	I/O	-300 V	Busbar	I/R, UE	
P600 M600		DC link DC link	I I	+300 V -300 V	16mm ² /10mm ² 4) 16mm ² /10mm ² 4)	MM	
1R, 2R, 3R		Connection, internal/ external resistor	I/O	± 300 V	16mm ² /10mm ² 4)	PR	
	X131	Electronics M	I/O	0 V	16mm ² /10mm ² 4)	I/R, UE, MM	
	X351	Equipment bus	I/O	Various	Ribbon cable	I/R, UE, MM, PR	
M500 P500	X181 X181	DC link power supply DC link power supply	I I	600 V/680 V DC 600 V/680 V DC	1.5 mm ² 1.5 mm ²	I/R, UE, MM	
1U1 2U1 1V1 2V1 1W1 2W1	X181 X181 X181 X181 X181 X181	Output L1 Input L1 Output L2 Input L2 Output L3 Input L3	O I O I O I	3-ph. 400 V/480 V AC 3-ph. 400 V/480 V AC 3-ph. 400 V/480 V AC 3-ph. 400 V/480 V AC 3-ph. 400 V/480 V AC 3-ph. 400 V/480 V AC	1.5 mm ² 1.5 mm ² 1.5 mm ² 1.5 mm ² 1.5 mm ² 1.5 mm ²		
7 45 44 10 15 R	X141 X141 X141 X141 X141 X141	P24 P15 N15 N24 M RESET ⁶⁾	O O O O O I	+20.4...28.8 V/50 mA +15 V/10 mA -15 V/10 mA -20.4...28.8 V/50 mA 0 V Term.15/R _E = 10 kΩ	1.5 mm ² 1.5 mm ² 1.5 mm ² 1.5 mm ² 1.5 mm ² 1.5 mm ²		
5.3 5.2 5.1 63 9 9 64 19	X121 X121 X121 X121 X121 X121 X121	} Relay contact Group signal I ² t/motor temp. Pulse enable ²⁾ Enable voltage ²⁾⁸⁾ Enable voltage ²⁾⁸⁾ Drive enable ²⁾ Enable voltage, ref. potential	NC NO I I O O I	50 V DC/0.5 A/12 VA max 5 V DC/3 mA min +13 V...30 V/R _E = 1.5 kΩ +24 V +24 V +13 V...30 V/R _E = 1.5 kΩ 0 V	1.5 mm ² 1.5 mm ² 1.5 mm ² 1.5 mm ² 1.5 mm ² 1.5 mm ² 1.5 mm ²		
74 nc 73.2 73.1 nc 72	X111 X111 X111 X111 X111 X111		} Relay contact Ready signal	NC I I I I NO	1-ph. 250V AC/50V DC/2A max 5V DC/3mA min		1.5 mm ² 1.5 mm ² 1.5 mm ² 1.5 mm ² 1.5 mm ² 1.5 mm ²

3.1 Terminals, NE, monitoring and pulsed resistor modules

Table 3-1 Terminal functions

Term. No.	Desig.	Function	Type ¹⁾	Typ. voltage/limit values	Max. cross-section	Terminals available in ³⁾
9 112	X161 X161	Enable voltage ²⁾⁸⁾ Setting-up operation/ Normal operation ²⁾	O I	+24 V +21 V...30 V/R _E = 1.5 kΩ	1.5 mm ² 1.5 mm ²	I/R, UE, MM
48 111 213 113	X161 X161X 161 X161	Contactor control ²⁾ Signaling contact Line contactor	I I NC 7) NO	+13 V...30 V/R _E = 1.5 kΩ +30 V/1 A (111–113) 1-ph. 250 VAC/50 V DC/ 2 A max 17 V DC/3 mA min	1.5 mm ² 1.5 mm ² 1.5 mm ² 1.5 mm ²	I/R, UE
AS1 AS2	X172 X172	Signaling contact Start inhibit (term.112)	I NC	250V AC/1A/50V DC/2A max 5 V DC/10 mA min	1.5 mm ² 1.5 mm ²	I/R
NS1 NS2	X171 X171	Coil contact for line supply, pre-charging contactor	O I	+24 V	1.5 mm ² 1.5 mm ²	I/R, UE
19 50	X221 X221	Enable voltage ref. po- tential Control contact for fast discharge	O I	0 V 0 V	1.5 mm ² 1.5 mm ²	PR

Notes:

- 1) I = Input, O = Output, NC = NC contact, NO = NO contact (for signal: closed = high, open = low)
- 2) Terminal 19 is the reference ground (this is connected inside the module to general reference ground X131/terminal 15 with 10 kΩ). Terminal 15 may **not** be connected to PE or to terminal 19. Do **not** connect external voltage sources to terminal 15! Terminal 19 can be connected to X131 .
- 3) I/R = Infeed/regenerative feedback module;
UE = Uncontrolled infeed;
MM= Monitoring module;
PR = Pulsed resistor module
- 4) The 1st data is valid with cable lug. The 2nd data is valid for finely-stranded conductor without end sleeve.
- 5) The grounding bar is used to ground the DC link M bus via 100 kΩ (this should be preferably inserted, for non-grounded line supplies, always insert).
- 6) RESET = Reset the fault memory, edge-triggered for the complete drive group (terminal R → terminal 15 = RESET)
- 7) Terminals 111–213, positive opening NC contact (for I/R 16 kW and UE 10kW only from Order No.[MLFB] 6SN114□-1□□01-0□□□).
- 8) Max. current load, terminal 9 – terminal 19: 0.5 A

NE

3.2 Terminals, UE module 5/10 kW

Table 3-2 Terminal functions

Term. No.	Designation	Function	Type ¹⁾	Typ. voltage limiting values	Max. cross-section		
U1 V1 W1	X1	Line supply	I	3-ph. 400 VAC/480 V	4 mm ² finely stranded without end sleeve 6 mm ² with cable lug		
PE1 PE2	–	Protective conductor	I	0 V	Thread M5		
	X131 X351	Electronics M Equipment bus Grounding bar ³⁾	I I/O I/O	0 V Various –300 V	Thread M4 34 core ribbon cable Busbar		
P600 M600		DC link DC link	I/O I/O	+300 V –300 V	Busbar Busbar		
M500 P500 1U1 2U1 1V1 2V1 1W1 2W1	X181 X181 X181 X181 X181 X181 X181 X181	DC link power supply DC link power supply Output L1 Input L1 Output L2 Input L2 Output L3 Input L3	I I O I O I O I	–300 V +300 V 3-ph. 400 V AC/480 V 3-ph. 400 V AC/480 V 3-ph. 400 V AC/480 V 3-ph. 400 V AC/480 V 3-ph. 400 V AC/480 V 3-ph. 400 V AC/480 V	1.5 mm ² 1.5 mm ² 1.5 mm ² 1.5 mm ² 1.5 mm ² 1.5 mm ² 1.5 mm ² 1.5 mm ²		
5.3 5.2 5.1 nc	X121A X121A X121A X121A	} Relay contact Group signal I ² t/motor temp.	NC NO I	1-ph. 50 V DC/0.5 A/12 VA max 1-ph. 5 V DC/3 mA min	1.5 mm ² 1.5 mm ² 1.5 mm ² 1.5 mm ²		
74 73.2 73.1 72	X121B X121B X121B X121B		} Relay signal Ready/ Fault	NC I I NO	1-ph. 250 V AC/50 V DC/2 A max 1-ph. 5 V DC/3 mA min	1.5 mm ² 1.5 mm ² 1.5 mm ² 1.5 mm ²	
63 9 9 64 R 19	X141A X141A X141A X141A X141A X141A			} Pulse enable ²⁾ FR+ ²⁾⁴⁾ FR+ ²⁾⁴⁾ Drive enable ²⁾ RESET ²⁾ FR–, reference ground, enable signal voltage	I O O I I O	+13 V...30 V/R _E = 1.5 kΩ +24 V +24 V +13 V...30 V/R _E = 1.5 kΩ 0/+24 V 0 V	1.5 mm ² 1.5 mm ² 1.5 mm ² 1.5 mm ² 1.5 mm ² 1.5 mm ²
111 213	X161 X161				} Signaling contact Line contactor	I NC	1-ph. 250 V AC/50 V DC/2 A 1-ph. 17 V DC/3 mA min
9 112 48 NS1 NS2 15	X141B X141B X141B X141B X141B X141B	} FR+ ²⁾⁴⁾ Setting-up/standard operation ²⁾ Contactor control ²⁾ Coil contact for line, pre-charging contactor M				O I I O I O	+24 V +13 V...30 V/R _E = 1.5 kΩ +13 V...30 V/R _E = 1.5 kΩ +24 V 0/+24 V 0 V

Notes:
1) I = Input, O = Output, NC = NC contact, NO = NO contact (for signal: closed = high, open = low)
2) Terminal 19 is the reference terminal (this is connected inside the module to general reference ground X131 with 10 kΩ).
3) The grounding bar is used to ground the DC link M busbar through 100 kΩ (this should be preferably inserted; always insert for non-grounded line supplies).
4) Max. current load, terminal 9 – terminal 19: 1 A



Feed Modules(VS)

1	Short Commissioning, Standard Settings	VS/1-3
1.1	Tachometer adaptation for motors with tachometer voltages 3 16.5 V at rated speed	VS/1-4
1.2	Current controller settings	VS/1-4
2	Speed Controller Optimization	VS/2-17
2.1	Tachometer calibration	VS/2-18
2.2	Setting the proportional gain Kp without adaptation	VS/2-19
2.3	Setting the integral action time TN without adaptation	VS/2-20
2.4	Integral action time with adaptation (if required)	VS/2-21
2.5	P gain with adaptation (only user-friendly interface)	VS/2-22
2.6	Setting the adaptation range (generally not required)	VS/2-23
2.7	I-component speed controller limiting	VS/2-23
2.8	Drift compensation (offset)	VS/2-23
3	Supplementary Commissioning Functions	VS/3-25
3.1	Setting elements with the standard interface	VS/3-25
3.1.1	Dimensioning the setting elements (Standard interface)	VS/3-27
3.2	Setting elements with user-friendly interface	VS/3-29
4	Setpoint Interfaces	VS/4-33
5	Commissioning with the MSD Option	VS/5-35
5.1	Pre-settings	VS/5-35
5.1.1	Settings with the control board withdrawn	VS/5-35
5.1.2	Settings in operation	VS/5-39
5.2	Analog outputs	VS/5-41
6	Free for Expansions	VS/6-43
7	Powering-Up	VS/7-45
8	Service and Diagnostics	VS/8-47
8.1	Test sockets and display elements of the feed modules	VS/8-47
8.1.1	User-friendly interface	VS/8-47
8.1.2	Standard interface	VS/8-49
8.2	Troubleshooting	VS/8-50

VS

9	Attachments	VS/9-51
9.1	Terminals	VS/9-51
9.2	Layout diagram MSD option board	VS/9-53
9.3	Layout diagram, parameter board	VS/9-54
9.4	Layout diagram, standard interface	VS/9-55
9.5	Layout diagram, speed control loop (user-friendly interface)	VS/9-56
9.6	Motor encoder, assignment of X311/X313 (1st/2nd axis)	VS/9-57

Short Commissioning, Standard Settings

1

The setting elements for the user-friendly interface are provided on the parameter board, and for the standard interface on the control (refer to Section 9 Attachment). For a standard commissioning procedure, the tachometer adaptation, current normalization and current controller gain parameters should be set.

VS

Commissioning stages of the FD modules with the user-friendly and standard interface

Commissioning is sub-divided into various stages; after the standard settings have been made, an additional commissioning stage can follow, or the unit can be powered-up.

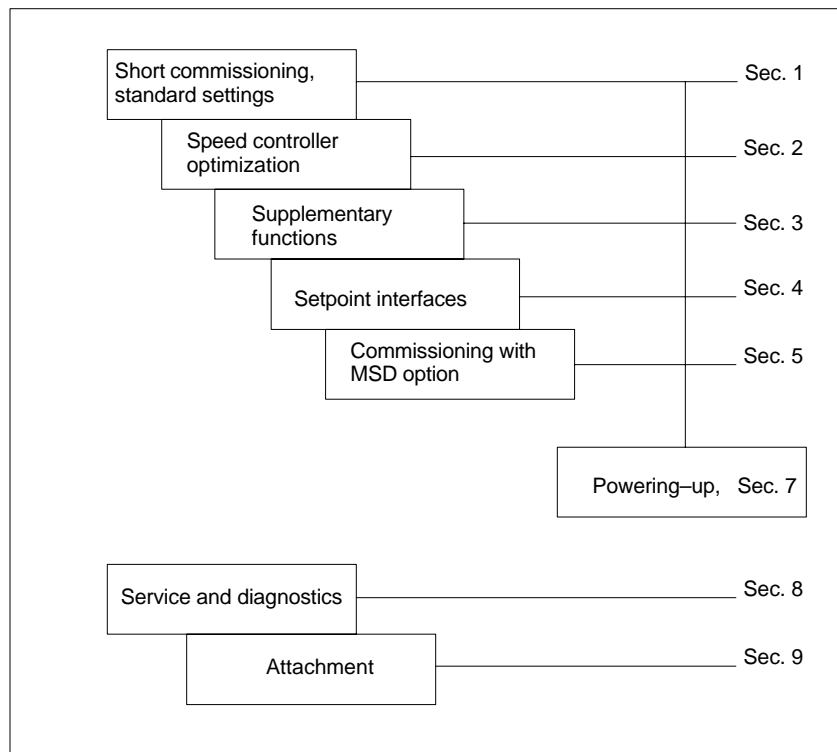

1.2 Current controller settings

1.1 Tachometer adaptation for motors with tachometer voltages ≤ 16.5 V at rated speed

Only involves motors 1FT503□–□AF71 and 1FT504□–□AF71

User-friendly and standard interface

All three contacts of switch S1 (S4 for a 2nd axis standard interface) = ON
In addition, discrete resistors can be used for calibration, refer to Sections 3.1 - 3.2.

1.2 Current controller settings

The settings for the current limit and current controller gain Kp(I) can be taken from the adaptation tables, Table 1-3 up to Table1-9. The values can be determined according to the formulas if the required feed module/motor combination cannot be found.

User-friendly interface

Parameter board, switch S2

Standard interface

Control board, switch S2 (**S5 for a 2nd axis**)

Note

The following setting values apply for both control versions unless specific differences are referred to in individual cases.

Actual value normalization

$$\text{Current limit} = \frac{I_{\text{max}} (\text{set maximum current})}{I_{\text{limit}} (\text{peak power module current})} \cdot 100 \quad [\%]$$

Table 1-1 Current limit

S2.x or S5.x to ON	–	2	3	2 3	4	2 4	3 4	2 3 4	5	2 5	3 5	2 3 5	4 5	2 4 5	3 4 5	2 3 4 5
(%)	100	85	68	61	50	46	41	39	36	34	30	29	26	25	24	23

The current limit must be at least reduced to the peak value permitted for the particular motor. This may have to be further reduced depending on the mechanical system.

Current controller gain Kp(I)

$$Kp(I) < \frac{I_{\max} \cdot L_D}{40}$$

I_{\max} = selected max. current of the axis in A

L_D = rotating field inductance of the motor in mH

(refer to the Planning Guide, AC Motors for Feed and Main Spindle Drives)

Table 1-2 Current controller gain

S2.x or S5.x to ON	–	6	7	6 7	8	6 8	7 8	9	6 9	7 9	6 7 9	8	7 8 9	6 7 8 9
Kp(I)	0.5	1	2	2.5	4	4.5	5.5	6	6.5	7.5	8	9.5	11	11.5

User-friendly interface

The current controller gain setting range can be additionally increased using R15 on the parameter board.

The following formula is valid for S2.6 to S2.9 closed (ON):

$$Kp(I) = 11.5 + \frac{1230 \Omega}{R15}$$

Adaptation tables

Table 1-3 Adaptation table for 6SN112□–1A□00–0HA1 4/8 A power module

1FT...	Servomotor			Current limit ¹⁾					Current controller gain				
	M _o [Nm]	I _o [A]	n _{rated} [RPM]	Contacts				I _{max} [A]	Contacts				Kp(I)
				2	3	4	5		6	7	8	9	
5034–□AK71	0.5	0.93	6000	x	o	x	o	3.68	o	x	o	o	2.0
5036–□AK71	0.75	1.4	6000	o	x	o	o	5.44	o	x	o	o	2.0
5042–□AF71	0.66	0.75	3000	x	o	o	x	2.72	x	x	o	o	2.5
5042–□AK71	0.66	1.2	6000	x	x	o	o	4.88	x	x	o	o	2.5
5044–□AF71	1.3	1.5	3000	o	x	o	o	5.44	x	x	o	o	2.5
5044–□AK71	1.3	2.3	6000	o	o	o	o	8.0	x	o	o	o	1.0
5046–□AF71	2.6	3.0	3000	o	o	o	o	8.0	o	x	o	o	2.0
5062–□AC71	2.2	1.3	2000	o	x	o	o	5.44	x	x	x	x	11.5
5062–□AF71	2.2	2.0	3000	o	o	o	o	8.0	o	x	o	x	7.5
5062–□AG71	2.2	2.7	4000	o	o	o	o	8.0	o	o	x	o	4.0
5062–□AK71	2.2	3.9	6000	o	o	o	o	8.0	x	o	o	o	1.0
5064–□AC71	4.5	2.7	2000	o	o	o	o	8.0	o	x	o	x	7.5
5066–□AC71	6.5	3.9	2000	o	o	o	o	8.0	x	o	x	o	4.5
5070–□AC71	3.0	1.8	2000	o	o	o	o	8.0	x	x	x	x	11.5
5070–□AF71	3.0	2.6	3000	o	o	o	o	8.0	o	x	o	x	7.5
5070–□AG71	3.0	3.6	4000	o	o	o	o	8.0	x	o	x	o	4.5
5071–□AC71	4.5	2.9	2000	o	o	o	o	8.0	x	x	o	x	8.0

Definition: o = Contact in the basic OFF setting
x = Contact in the ON setting

- 1) The specified value is the maximum permissible current of the particular power module/motor combination. It may be necessary to reduce the specified value depending on the driven mechanical systems.

1.2 Current controller settings

Table 1-4 Adaptation table for 6SN112□-1A□00-0AA1 7.5/15 A power modules

Servomotor				Current limit ¹⁾					Current controller gain				
1FT...	M ₀ [Nm]	I ₀ [A]	n _{rated} [RPM]	Contacts				I _{max} [A]	Contacts				Kp(I)
				2	3	4	5		6	7	8	9	
5034-□AK71	0.5	0.93	6000	o	x	x	x	3.68	o	x	o	o	2.0
5036-□AK71	0.75	1.4	6000	o	o	o	x	5.44	o	x	o	o	2.0
5042-□AF71	0.66	0.75	3000	x	x	x	x	3.45	o	o	x	o	4.0
5042-□AK71	0.66	1.2	6000	x	x	o	x	4.5	o	x	o	o	2.0
5044-□AF71	1.3	1.5	3000	x	x	x	o	5.85	o	o	x	o	4.0
5044-□AK71	1.3	2.3	6000	x	x	o	o	9.15	o	x	o	o	2.0
5046-□AF71	2.6	3.0	3000	x	o	o	o	12.7	o	o	x	o	4.0
5046-□AK71	2.6	4.7	6000	o	o	o	o	15.0	x	o	o	o	1.0
5062-□AC71	2.2	1.3	2000	x	o	o	x	5.1	o	x	x	x	11.0
5062-□AF71	2.2	2.0	3000	o	o	x	o	7.5	x	o	o	x	6.5
5062-□AG71	2.2	2.7	4000	o	x	o	o	10.2	o	x	x	o	5.5
5062-□AK71	2.2	3.9	6000	o	o	o	o	15.0	x	x	o	o	2.5
5064-□AC71	4.5	2.7	2000	o	x	o	o	10.2	o	o	x	x	9.5
5064-□AF71	4.5	4.1	3000	o	o	o	o	15.0	x	o	o	x	6.5
5064-□AG71	4.5	5.5	4000	o	o	o	o	15.0	x	x	o	o	2.5
5066-□AC71	6.5	3.9	2000	o	o	o	o	15.0	o	o	x	x	9.5
5066-□AF71	6.5	6.0	3000	o	o	o	o	15.0	o	o	x	o	4.0
5070-□AC71	3.0	1.8	2000	o	o	x	o	7.5	x	x	x	x	11.5
5070-□AF71	3.0	2.6	3000	o	x	o	o	10.2	o	o	x	x	9.5
5070-□AG71	3.0	3.6	4000	o	o	o	o	15.0	x	x	o	x	8.0
5070-□AK71	3.0	5.3	6000	o	o	o	o	15.0	o	o	x	o	4.0
5071-□AC71	4.5	2.9	2000	x	o	o	o	12.7	x	x	x	x	11.5
5071-□AF71	4.5	4.3	3000	o	o	o	o	15.0	x	o	o	x	6.5
5071-□AG71	4.5	5.2	4000	o	o	o	o	15.0	x	o	x	o	4.5
5072-□AC71	10.0	6.1	2000	o	o	o	o	15.0	x	x	o	x	8.0
5073-□AC71	7.0	4.3	2000	o	o	o	o	15.0	o	o	x	x	9.5
5073-□AF71	7.0	6.4	3000	o	o	o	o	15.0	o	o	x	o	4.0
5100-□AC71	10.0	6.2	2000	o	o	o	o	15.0	o	x	x	o	5.5

Definition: o = Contact in the basic OFF setting
 x = Contact in the ON setting

1) The specified value is the maximum permissible current of the particular power module/motor combination. It may be necessary to reduce the specified value depending on the driven mechanical systems.

1.2 Current controller settings

Table 1-5 Adaptation table for 6SN112□-1A□00-0BA1 12.5/25 A power modules

Servomotor				Current limit ¹⁾					Current controller gain				
1FT...	M ₀ [Nm]	I ₀ [A]	n _{rated} [RPM]	Contacts				I _{max} [A]	Contacts				Kp(I)
				2	3	4	5		6	7	8	9	
5036-□AK71	0.75	1.4	6000	x	x	x	x	5.75	o	x	o	o	2.0
5044-□AF71	1.3	1.5	3000	o	x	x	x	6.0	o	o	x	o	4.0
5044-□AK71	1.3	2.3	6000	o	o	o	x	9.0	o	x	o	o	2.0
5046-□AF71	2.6	3.0	3000	o	o	x	o	12.5	o	o	x	o	4.0
5046-□AK71	2.6	4.7	6000	o	x	o	o	17.0	o	x	o	o	2.0
5062-□AC71	2.2	1.3	2000	x	x	x	x	5.75	x	x	x	x	11.5
5062-□AF71	2.2	2.0	3000	x	o	o	x	8.5	x	x	o	x	8.0
5062-□AG71	2.2	2.7	4000	x	o	x	o	10.25	o	x	x	o	5.5
5062-□AK71	2.2	3.9	6000	x	x	o	o	15.75	x	x	o	o	2.5
5064-□AC71	4.5	2.7	2000	x	o	x	o	10.25	x	x	x	x	11.5
5064-□AF71	4.5	4.1	3000	o	x	o	o	17.0	x	o	o	x	6.5
5064-□AG71	4.5	5.5	4000	o	o	o	o	25.0	o	x	x	o	5.5
5064-□AK71	4.5	8.0	6000	o	o	o	o	25.0	x	x	o	o	2.5
5066-□AC71	6.5	3.9	2000	o	x	o	o	17.0	o	o	x	x	9.5
5066-□AF71	6.5	6.0	3000	o	o	o	o	25.0	x	o	o	x	6.5
5066-□AG71	6.5	7.9	4000	o	o	o	o	25.0	x	x	o	o	2.5
5066-□AK71	6.5	11.6	6000	o	o	o	o	25.0	o	x	o	o	2.0
5070-□AC71	3.0	1.8	2000	o	x	o	x	7.5	x	x	x	x	11.5
5070-□AF71	3.0	2.6	3000	x	o	x	o	11.5	o	x	x	x	11.0
5070-□AG71	3.0	3.6	4000	o	x	o	o	17.0	o	o	x	x	9.5
5070-□AK71	3.0	5.3	6000	o	o	o	o	25.0	x	o	o	x	6.5
5071-□AC71	4.5	2.9	2000	o	o	x	o	12.5	x	x	x	x	11.5
5071-□AF71	4.5	4.3	3000	o	x	o	o	17.0	x	x	o	x	8.0
5071-□AG71	4.5	5.2	4000	o	o	o	o	25.0	x	x	o	x	8.0
5071-□AK71	4.5	7.9	6000	o	o	o	o	25.0	x	x	o	o	2.5
5072-□AC71	10.0	6.1	2000	o	o	o	o	25.0	x	x	x	x	11.5
5072-□AF71	10.0	9.1	3000	o	o	o	o	25.0	o	o	o	x	6.0
5072-□AG71	10.0	12.0	4000	o	o	o	o	25.0	x	x	o	o	2.5
5073-□AC71	7.0	4.3	2000	o	x	o	o	17.0	o	o	x	x	9.5
5073-□AF71	7.0	6.4	3000	o	o	o	o	25.0	x	o	o	x	6.5
5073-□AG71	7.0	8.1	4000	o	o	o	o	25.0	x	o	x	o	4.5
5073-□AK71	7.0	12.5	6000	o	o	o	o	25.0	x	o	o	o	1.0
5074-□AC71	14.0	8.5	2000	o	o	o	o	25.0	x	x	o	x	8.0
5076-□AC71	18.0	11.5	2000	o	o	o	o	25.0	o	x	x	o	5.5
5100-□AC71	10.0	6.2	2000	o	o	o	o	25.0	o	o	x	x	9.5
5100-□AF71	10.0	9.2	3000	o	o	o	o	25.0	o	o	x	o	4.0
5100-□AG71	10.0	12.5	4000	o	o	o	o	25.0	x	x	o	o	2.5
5101-□AC71	15.0	9.4	2000	o	o	o	o	25.0	o	x	x	o	5.5
5102-□AA71	27.0	9.9	1200	o	o	o	o	25.0	x	x	o	x	8.0
5103-□AC71	19.0	12.0	2000	o	o	o	o	25.0	o	o	x	o	4.0

Definition: o = Contact in the basic OFF setting
x = Contact in the ON setting

- 1) The specified value is the maximum permissible current of the particular power module/motor combination. It may be necessary to reduce the specified value depending on the driven mechanical systems.

1.2 Current controller settings

Table 1-6 Adaptation table for 6SN112□-1A□00-0CA1 25/50 A power modules

Servomotor				Current limit ¹⁾					Current controller gain				
1FT...	M ₀ [Nm]	I ₀ [A]	n _{rated} [RPM]	Contacts				I _{max} [A]	Contacts				Kp(I)
				2	3	4	5		6	7	8	9	
5044-□AK71	1.3	2.3	6000	o	o	x	x	13.0	x	x	o	o	2.5
5046-□AF71	2.6	3.0	3000	o	x	o	x	15.0	o	o	x	o	4.0
5046-□AK71	2.6	4.7	6000	o	o	x	o	25.0	x	x	o	o	2.5
5062-□AG71	2.2	2.7	4000	x	o	x	x	13.0	x	o	o	x	6.5
5062-□AK71	2.2	3.9	6000	o	x	x	o	19.5	x	o	x	o	4.5
5064-□AC71	4.5	2.7	2000	o	o	x	x	13.0	x	x	x	x	11.5
5064-□AF71	4.5	4.1	3000	x	x	x	o	19.5	x	x	o	x	8.0
5064-□AG71	4.5	5.5	4000	o	o	x	o	25.0	o	x	x	o	5.5
5064-□AK71	4.5	8.0	6000	o	x	o	o	34.0	x	x	o	o	2.5
5066-□AC71	6.5	3.9	2000	x	x	x	o	19.5	x	x	x	x	11.5
5066-□AF71	6.5	6.0	3000	x	x	o	o	30.5	x	x	o	x	8.0
5066-□AG71	6.5	7.9	4000	o	x	o	o	34.0	x	o	x	o	4.5
5066-□AK71	6.5	11.6	6000	o	o	o	o	50.0	o	o	x	o	4.0
5070-□AF71	3.0	2.6	3000	o	x	x	x	12.0	x	x	x	x	11.5
5070-□AG71	3.0	3.6	4000	x	o	o	x	17.0	o	o	x	x	9.5
5070-□AK71	3.0	5.3	6000	o	o	x	o	25.0	x	o	o	x	6.5
5071-□AC71	4.5	2.9	2000	o	o	x	x	13.0	x	x	x	x	11.5
5071-□AF71	4.5	4.3	3000	o	x	x	o	20.5	o	o	x	x	9.5
5071-□AG71	4.5	5.2	4000	o	o	x	o	25.0	x	x	o	x	8.0
5071-□AK71	4.5	7.9	6000	o	x	o	o	34.0	o	o	x	o	4.0
5072-□AC71	10.0	6.1	2000	o	o	x	o	25.0	x	x	x	x	11.5
5072-□AF71	10.0	9.1	3000	x	o	o	o	42.5	o	o	x	x	9.5
5072-□AG71	10.0	12.0	4000	o	o	o	o	50.0	x	o	o	x	6.5
5072-□AK71	10.0	17.5	6000	o	o	o	o	50.0	x	x	o	o	2.5
5073-□AC71	7.0	4.3	2000	o	x	x	o	20.5	x	x	x	x	11.5
5073-□AF71	7.0	6.4	3000	x	x	o	o	30.5	x	x	o	x	8.0
5073-□AG71	7.0	8.1	4000	x	o	o	o	42.5	o	x	o	x	7.5
5073-□AK71	7.0	12.5	6000	o	o	o	o	50.0	x	x	o	o	2.5
5074-□AC71	14.0	8.5	2000	x	o	o	o	42.5	x	x	x	x	11.5
5074-□AF71	14.0	13.0	3000	o	o	o	o	50.0	x	o	o	x	6.5
5074-□AG71	14.0	16.5	4000	o	o	o	o	50.0	x	o	x	o	4.5
5074-□AK71	14.0	25.0	6000	o	o	o	o	50.0	x	o	o	o	1.0
5076-□AC71	18.0	11.5	2000	o	o	o	o	50.0	o	x	x	x	11.0
5076-□AF71	18.0	16.5	3000	o	o	o	o	50.0	x	o	x	o	4.5
5076-□AG71	18.0	21.5	4000	o	o	o	o	50.0	x	x	o	o	2.5
5100-□AC71	10.0	6.2	2000	x	x	o	o	30.5	x	x	x	x	11.5
5100-□AF71	10.0	9.2	3000	x	o	o	o	42.5	x	o	o	x	6.5
5100-□AG71	10.0	12.5	4000	o	o	o	o	50.0	x	o	x	o	4.5
5100-□AK71	10.0	18.0	6000	o	o	o	o	50.0	x	x	o	o	2.5
5101-□AC71	15.0	9.4	2000	x	o	o	o	42.5	o	o	x	x	9.5
5101-□AF71	15.0	14.5	3000	o	o	o	o	50.0	x	o	x	o	4.5
5101-□AG71	15.0	17.5	4000	o	o	o	o	50.0	x	x	o	o	2.5
5102-□AA71	27.0	9.9	1200	x	o	o	o	42.5	x	x	x	x	11.5
5102-□AC71	27.0	16.5	2000	o	o	o	o	50.0	x	o	o	x	6.5
5102-□AF71	27.0	25.0	3000	o	o	o	o	50.0	x	x	o	o	2.5

Definition: o = Contact in the basic OFF setting
 x = Contact in the ON setting

- 1) The specified value is the maximum permissible current of the particular power module/motor combination. It may be necessary to reduce the specified value depending on the driven mechanical systems.

Table 1-6 Adaptation table for 6SN112□-1AA00-0CA1 25/50 A power modules, continued

Servomotor				Current limit ¹⁾					Current controller gain				
1FT...	M ₀ [Nm]	I ₀ [A]	n _{rated} [RPM]	Contacts				I _{max} [A]	Contacts				Kp(I)
				2	3	4	5		6	7	8	9	
5103-□AC71	19.0	12.0	2000	o	o	o	o	50.0	x	x	o	o	8.0
5103-□AF71	19.0	17.5	3000	o	o	o	o	50.0	x	x	o	o	2.5
5103-□AG71	19.0	23.0	4000	o	o	o	o	50.0	o	x	o	x	2.0
5104-□AA71	37.0	14.0	1200	o	o	o	o	50.0	x	x	x	x	11.5
5104-□AC71	37.0	22.5	2000	o	o	o	o	50.0	o	o	x	o	4.0
5106-□AA71	45.0	17.0	1200	o	o	o	o	50.0	x	x	o	x	8.0
5108-□AA71	55.0	20.5	1200	o	o	o	o	50.0	x	o	o	x	6.5
5132-□AA71	60.0	22.5	1200	o	o	o	o	50.0	o	x	o	x	7.5

Definition: o = Contact in the basic OFF setting
 x = Contact in the ON setting

VS

1) The specified value is the maximum permissible current of the particular power module/motor combination. It may be necessary to reduce the specified value depending on the driven mechanical systems.

1.2 Current controller settings

Table 1-7 Adaptation table for 6SN112□-1AA00-0DA1 40/80 A power modules

Servomotor				Current limit ¹⁾					Current controller gain				
1FT	M ₀ [Nm]	I ₀ [A]	n _{rated} [RPM]	Contacts				I _{max} [A]	Contacts				Kp(I)
				2	3	4	5		6	7	8	9	
4101-□SK71	20.0	33.0	6000	o	o	o	o	80.0	o	x	o	o	2.0
4101-□SN71	20.0	39.0	8000	o	o	o	o	80.0	x	o	o	o	1.0
4102-□SG71	33.0	35.0	4000	o	o	o	o	80.0	o	o	x	o	4.0
5046-□AK71	2.6	4.7	6000	o	x	o	x	24.0	x	x	o	o	2.5
5062-□AK71	2.2	3.9	6000	o	x	x	x	19.2	o	o	x	o	4.0
5064-□AF71	4.5	4.1	3000	o	x	x	x	19.2	x	x	o	x	8.0
5064-□AG71	4.5	5.5	4000	o	o	o	x	28.8	x	o	o	x	6.5
5064-□AK71	4.5	8.0	6000	o	o	x	o	40.0	o	o	x	o	4.0
5066-□AC71	6.5	3.9	2000	o	x	x	x	19.2	x	x	x	x	11.5
5066-□AF71	6.5	6.0	3000	o	o	o	x	28.2	x	x	o	x	8.0
5066-□AG71	6.5	7.9	4000	o	o	x	o	40.0	o	o	o	x	6.0
5066-□AK71	6.5	11.6	6000	o	x	o	o	54.4	x	o	x	o	4.5
5070-□AK71	3.0	5.3	6000	o	x	o	x	24.0	x	o	o	x	6.5
5071-□AF71	4.5	4.3	3000	o	o	x	x	20.8	o	o	x	x	9.5
5071-□AG71	4.5	5.2	4000	x	o	o	x	27.2	x	x	o	x	8.0
5071-□AK71	4.5	7.9	6000	o	o	x	o	40.0	x	o	x	o	4.5
5072-□AC71	10.0	6.1	2000	o	o	o	x	28.8	x	x	x	x	11.5
5072-□AF71	10.0	9.1	3000	o	o	x	o	40.0	o	o	x	x	9.5
5072-□AG71	10.0	12.0	4000	o	x	o	o	54.4	o	x	o	x	7.5
5072-□AK71	10.0	17.5	6000	o	o	o	o	80.0	o	x	x	o	5.5
5073-□AC71	7.0	4.3	2000	o	o	x	x	20.8	x	x	x	x	11.5
5073-□AF71	7.0	6.4	3000	x	x	x	o	31.2	x	x	o	x	8.0
5073-□AG71	7.0	8.1	4000	o	o	x	o	40.0	x	o	o	x	6.5
5073-□AK71	7.0	12.5	6000	o	x	o	o	54.4	x	x	o	o	2.5
5074-□AC71	14.0	8.5	2000	o	o	x	o	40.0	x	x	x	x	11.5
5074-□AF71	14.0	13.0	3000	o	x	o	o	54.4	o	x	o	x	7.5
5074-□AG71	14.0	16.5	4000	o	o	o	o	80.0	x	o	o	x	6.5
5074-□AK71	14.0	25.0	6000	o	o	o	o	80.0	x	x	o	o	2.5
5074-□SG71	16.0	19.0	4000	o	o	o	o	80.0	o	o	o	x	6.0
5074-□SK71	16.0	28.0	6000	o	o	o	o	80.0	x	x	o	o	2.5
5076-□AC71	18.0	11.5	2000	x	x	o	o	48.8	o	x	x	x	11.0
5076-□AF71	18.0	16.5	3000	x	o	o	o	68.0	x	o	o	x	6.5
5076-□AG71	18.0	21.5	4000	o	o	o	o	80.0	x	o	x	o	4.5
5076-□AK71	18.0	32.0	6000	o	o	o	o	80.0	o	x	o	o	2.0
5076-□SG71	20.5	24.5	4000	o	o	o	o	80.0	o	o	x	o	4.0
5100-□AC71	10.0	6.2	2000	x	x	x	o	31.2	x	x	x	x	11.5
5100-□AF71	10.0	9.2	3000	o	o	x	o	40.0	x	o	o	x	6.5
5100-□AG71	10.0	12.5	4000	o	x	o	o	54.4	o	x	x	o	5.5
5100-□AK71	10.0	18.0	6000	o	o	o	o	80.0	o	o	x	o	4.0
5101-□AC71	15.0	9.4	2000	o	o	x	o	40.0	x	x	o	x	8.0
5101-□AF71	15.0	14.5	3000	o	x	o	o	54.4	o	x	x	o	5.5
5101-□AG71	15.0	17.5	4000	o	o	o	o	80.0	x	o	x	o	4.5
5101-□AK71	15.0	26.5	6000	o	o	o	o	80.0	o	x	o	o	2.0

Definition: o = Contact in the basic OFF setting
x = Contact in the ON setting

1) The specified value is the maximum permissible current of the particular power module/motor combination. It may be necessary to reduce the specified value depending on the driven mechanical systems.

Table 1-7 Adaptation table for 6SN112□-1AA00-0DA1 40/80 A power modules, continued

Servomotor				Current limit ¹⁾					Current controller gain				
1FT	M ₀ [Nm]	I ₀ [A]	n _{rated} [RPM]	Contacts				I _{max} [A]	Contacts				Kp(I)
				2	3	4	5		6	7	8	9	
5102-□AA71	27.0	9.9	1200	o	o	x	o	40.0	x	x	x	x	11.5
5102-□AC71	27.0	16.5	2000	o	o	o	o	80.0	o	o	x	x	9.5
5102-□AF71	27.0	25.0	3000	o	o	o	o	80.0	o	o	x	o	4.0
5102-□AG71	27.0	31.5	4000	o	o	o	o	80.0	x	x	o	o	2.5
5103-□AC71	19.0	12.0	2000	o	x	o	o	54.4	x	x	o	x	8.0
5103-□AF71	19.0	17.5	3000	o	o	o	o	80.0	o	o	o	x	6.0
5103-□AG71	19.0	23.0	4000	o	o	o	o	80.0	x	x	o	o	2.5
5104-□AA71	37.0	14.0	1200	o	x	o	o	54.4	x	x	x	x	11.5
5104-□AC71	37.0	22.5	2000	o	o	o	o	80.0	x	o	o	x	6.5
5104-□AF71	37.0	34.0	3000	o	o	o	o	80.0	x	x	o	o	2.5
5106-□AA71	45.0	17.0	1200	o	o	o	o	80.0	x	x	x	x	11.5
5106-□AC71	45.0	26.8	2000	o	o	o	o	80.0	o	x	x	o	5.5
5108-□AA71	55.0	20.5	1200	o	o	o	o	80.0	x	x	x	x	11.5
5108-□AC71	55.0	32.5	2000	o	o	o	o	80.0	x	o	x	o	4.5
5132-□AA71	60.0	22.5	1200	o	o	o	o	80.0	x	x	x	x	11.5
5132-□AC71	60.0	35.5	2000	o	o	o	o	80.0	x	o	x	o	4.5
5132-□SA71	70.0	26.0	1200	o	o	o	o	80.0	x	x	x	x	11.5
5134-□AA71	75.0	28.0	1200	o	o	o	o	80.0	o	o	x	x	9.5
5134-□SA71	90.0	34.0	1200	o	o	o	o	80.0	o	o	x	x	9.5
5136-□AA71	85.0	31.5	1200	o	o	o	o	80.0	o	x	o	x	7.5
5138-□AA71	105.0	39.0	1200	o	o	o	o	80.0	o	o	o	x	6.0

Definition: o = Contact in the basic OFF setting
 x = Contact in the ON setting

1) The specified value is the maximum permissible current of the particular power module/motor combination. It may be necessary to reduce the specified value depending on the driven mechanical systems.

1.2 Current controller settings

Table 1-8 Adaptation table for 6SN112□-1AA00-0EA1 80/160 A power modules

Servomotor				Current limit ¹⁾					Current controller gain				
1FT	M ₀ [Nm]	I ₀ [A]	n _{rated} [RPM]	Contacts				I _{max} [A]	Contacts				Kp(I)
				2	3	4	5		6	7	8	9	
4101-□SK71	20.0	33.0	6000	o	o	o	o	160.0	x	o	x	o	4.5
4101-□SN71	20.0	39.0	8000	o	o	o	o	160.0	x	x	o	o	2.5
4102-□SG71	33.0	35.0	4000	o	o	o	o	160.0	x	x	o	x	8.0
4102-□SK71	33.0	47.0	6000	o	o	o	o	160.0	x	o	x	o	4.5
4104-□SG71	45.0	46.0	4000	o	o	o	o	160.0	o	x	x	o	5.5
4104-□SK71	45.0	60.0	6000	o	o	o	o	160.0	x	x	o	o	2.5
4106-□SG71	59.0	56.0	4000	o	o	o	o	160.0	x	o	x	o	4.5
5064-□AK71	4.5	8.0	6000	o	o	x	x	41.6	x	o	x	o	4.5
5066-□AG71	6.5	7.9	4000	o	x	x	x	38.4	o	o	o	x	6.0
5066-□AK71	6.5	11.6	6000	o	o	o	x	57.6	x	o	x	o	4.5
5071-□AK71	4.5	7.9	6000	o	x	x	x	38.4	x	o	x	o	4.5
5072-□AF71	10.0	9.1	3000	o	o	x	x	41.6	o	o	x	x	9.5
5072-□AG71	10.0	12.0	4000	o	o	o	x	57.6	x	x	o	x	8.0
5072-□AK71	10.0	17.5	6000	o	o	x	o	80.0	o	x	x	o	5.5
5073-□AG71	7.0	8.1	4000	o	o	x	x	41.6	x	o	o	x	6.5
5073-□AK71	7.0	12.5	6000	o	x	x	o	65.5	o	o	x	o	4.0
5074-□AC71	14.0	8.5	2000	o	o	x	x	41.6	x	x	x	x	11.5
5074-□AF71	14.0	13.0	3000	o	x	x	o	65.6	x	x	o	x	8.0
5074-□AG71	14.0	16.5	4000	o	o	x	o	80.0	x	o	o	x	6.5
5074-□AK71	14.0	25.0	6000	x	x	o	o	97.6	x	x	o	o	2.5
5074-□SG71	16.0	19.0	4000	o	o	x	o	80.0	o	x	x	o	5.5
5074-□SK71	16.0	28.0	6000	x	x	o	o	97.0	x	x	o	o	2.5
5076-□AC71	18.0	11.5	2000	o	x	o	x	48.0	o	o	x	x	9.5
5076-□AF71	18.0	16.5	3000	x	o	x	o	73.6	o	x	o	x	7.5
5076-□AG71	18.0	21.5	4000	o	x	o	o	108.8	x	o	o	x	6.5
5076-□AK71	18.0	32.0	6000	o	o	o	o	160.0	o	o	x	o	4.0
5076-□SG71	20.5	24.5	4000	o	x	o	o	108.8	o	x	x	o	5.5
5076-□SK71	20.5	36.0	6000	o	o	o	o	160.0	o	o	x	o	4.0
5100-□AF71	10.0	9.2	3000	x	x	o	x	46.4	x	x	o	x	8.0
5100-□AG71	10.0	12.5	4000	x	x	x	o	62.4	x	o	o	x	6.5
5100-□AK71	10.0	18.0	6000	o	o	x	o	80.0	o	o	x	o	4.0
5101-□AC71	15.0	9.4	2000	o	o	x	x	41.6	o	o	x	x	9.5
5101-□AF71	15.0	14.5	3000	o	x	x	o	65.6	x	o	o	x	6.5
5101-□AG71	15.0	17.5	4000	o	o	x	o	80.0	x	o	x	o	4.5
5101-□AK71	15.0	26.5	6000	x	o	o	o	136.0	o	o	x	o	4.0
5102-□AA71	27.0	9.9	1200	x	x	o	x	46.4	x	x	x	x	11.5
5102-□AC71	27.0	16.5	2000	o	o	x	o	80.0	o	o	x	x	9.5
5102-□AF71	27.0	25.0	3000	o	x	o	o	108.8	o	x	x	o	5.5
5102-□AG71	27.0	31.5	4000	o	o	o	o	160.0	o	x	x	o	5.5
5102-□SF71	34.0	31.5	3000	o	x	o	o	108.8	x	o	x	o	4.5
5102-□SG71	34.0	39.5	4000	o	o	o	o	160.0	x	o	x	o	4.5
5103-□AC71	19.0	12.0	2000	o	o	o	x	57.6	x	x	o	x	8.0
5103-□AF71	19.0	17.5	3000	o	o	x	o	80.0	o	o	o	x	6.0
5103-□AG71	19.0	23.0	4000	o	x	o	o	108.8	x	o	x	o	4.5

Definition: o = Contact in the basic OFF setting
x = Contact in the ON setting

1) The specified value is the maximum permissible current of the particular power module/motor combination. It may be necessary to reduce the specified value depending on the driven mechanical systems.

Table 1-8 Adaptation table for 6SN112□-1AA00-0EA1 80/160 A power modules, continued

Servomotor				Current limit ¹⁾					Current controller gain				
1FT	M ₀ [Nm]	I ₀ [A]	n _{rated} [RPM]	Contacts				I _{max} [A]	Contacts				Kp(I)
				2	3	4	5		6	7	8	9	
5104-□AA71	37.0	14.0	1200	x	x	x	o	62.4	x	x	x	x	11.5
5104-□AC71	37.0	22.5	2000	o	x	o	o	108.8	o	o	x	x	9.5
5104-□AF71	37.0	34.0	3000	o	o	o	o	160.0	x	o	o	x	6.5
5104-□SF71	48.0	44.0	3000	o	o	o	o	160.0	o	x	x	o	5.5
5106-□AA71	45.0	17.0	1200	o	o	x	o	80.0	x	x	x	x	11.5
5106-□AC71	45.0	26.8	2000	o	x	o	o	108.0	o	x	o	x	7.5
5106-□AF71	45.0	42.5	3000	o	o	o	o	160.0	x	o	x	o	4.5
5106-□SF71	57.0	54.0	3000	o	o	o	o	160.0	o	o	x	o	4.0
5108-□AA71	55.0	20.5	1200	o	o	x	o	80.0	x	x	x	x	11.5
5108-□AC71	55.0	32.5	2000	o	o	o	o	160.0	o	o	x	x	9.5
5108-□AF71	55.0	50.5	3000	o	o	o	o	160.0	o	o	x	o	4.0
5132-□AA71	60.0	22.5	1200	o	x	o	o	108.8	x	x	x	x	11.5
5132-□AC71	60.0	35.5	2000	o	o	o	o	160.0	x	x	o	x	8.0
5132-□AF71	60.0	47.5	3000	o	o	o	o	160.0	o	x	x	o	5.5
5132-□SA71	70.0	26.0	1200	o	x	o	o	108.8	x	x	x	x	11.5
5132-□SC71	70.0	41.0	2000	o	o	o	o	160.0	x	x	o	x	8.0
5132-□SF71	70.0	55.5	3000	o	o	o	o	160.0	x	x	x	o	5.5
5134-□AA71	75.0	28.0	1200	o	x	o	o	108.8	x	x	x	x	11.5
5134-□AC71	75.0	47.0	2000	o	o	o	o	160.0	x	o	o	o	6.5
5134-□SA71	90.0	34.0	1200	o	x	o	o	108.8	x	x	x	x	11.5
5134-□SC71	90.0	56.0	2000	o	o	o	o	160.0	x	o	o	x	6.5
5136-□AA71	85.0	31.5	1200	x	o	o	o	136.0	x	x	x	x	11.5
5136-□AC71	85.0	47.5	2000	o	o	o	o	160.0	x	o	o	x	6.5
5136-□SA71	110.0	41.0	1200	x	o	o	o	136.0	x	x	x	x	11.5
5136-□SC71	110.0	61.5	2000	o	o	o	o	160.0	x	o	o	o	6.5
5138-□AA71	105.0	39.0	1200	o	o	o	o	160.0	x	x	x	x	11.5
5138-□SA71	140.0	52.0	1200	o	o	o	o	160.0	x	x	x	x	11.5

Definition: o = Contact in the basic OFF setting
 x = Contact in the ON setting

1) The specified value is the maximum permissible current of the particular power module/motor combination. It may be necessary to reduce the specified value depending on the driven mechanical systems.

1.2 Current controller settings

Table 1-9 Adaptation table for 6SN112□-1AA00-0FA1 100/200 A power modules

Servomotor				Current limit ¹⁾					Current controller gain				
1FT	M ₀ [Nm]	I ₀ [A]	n _{rated} [RPM]	Contacts				I _{max} [A]	Contacts				Kp(I)
				2	3	4	5		6	7	8	9	
4101-□SK71	20.0	33.0	6000	o	x	o	o	136.0	x	x	o	o	2.5
4101-□SN71	20.0	39.0	8000	x	o	o	o	170.0	x	x	o	o	2.0
4102-□SG71	33.0	35.0	4000	x	o	o	o	170.0	o	o	x	x	9.5
4102-□SK71	33.0	47.0	6000	o	o	o	o	200.0	o	x	x	o	5.5
4104-□SG71	45.0	46.0	4000	o	o	o	o	200.0	x	o	o	x	6.5
4104-□SK71	45.0	60.0	6000	o	o	o	o	200.0	x	x	o	o	2.5
4106-□SG71	59.0	56.0	4000	o	o	o	o	200.0	o	x	x	o	5.5
5066-□AK71	6.5	11.6	6000	o	x	o	x	60.0	x	o	x	o	4.5
5072-□AG71	10.0	12.0	4000	o	x	o	x	60.0	x	x	o	x	8.0
5072-□AK71	10.0	17.5	6000	o	x	x	o	82.0	o	x	x	o	5.5
5073-□AK71	7.0	12.5	6000	o	x	o	x	60.0	o	o	x	o	4.0
5074-□AF71	14.0	13.0	3000	o	x	o	x	60.0	x	x	o	x	8.0
5074-□AG71	14.0	16.5	4000	o	x	x	o	82.0	x	o	o	x	6.5
5074-□AK71	14.0	25.0	6000	o	o	x	o	100.0	x	x	o	o	2.5
5074-□SG71	16.0	19.0	4000	o	x	x	o	82.0	o	o	o	x	6.0
5074-□SK71	16.0	28.0	6000	o	o	x	o	100.0	x	x	o	o	2.5
5076-□AC71	18.0	11.5	2000	o	o	x	x	52.0	x	x	x	x	11.5
5076-□AF71	18.0	16.5	3000	x	x	x	o	78.0	x	x	o	x	8.0
5076-□AG71	18.0	21.5	4000	o	o	x	o	100.0	o	x	x	o	5.5
5076-□AK71	18.0	32.0	6000	o	x	o	o	136.0	x	x	o	o	2.5
5076-□SG71	20.5	24.5	4000	o	o	x	o	100.0	x	o	x	o	4.5
5076-□SK71	20.5	36.0	6000	o	x	o	o	136.0	x	x	o	o	2.5
5100-□AF71	10.0	9.2	3000	x	x	x	x	46.0	x	x	o	x	8.0
5100-□AG71	10.0	12.5	4000	o	x	o	x	60.0	o	o	o	x	6.0
5100-□AK71	10.0	18.0	6000	x	o	x	o	92.0	x	o	x	o	4.5
5101-□AC71	15.0	9.4	2000	x	x	x	x	46.0	o	o	x	x	9.5
5101-□AF71	15.0	14.5	3000	o	x	o	x	60.0	o	o	o	x	6.0
5101-□AG71	15.0	17.5	4000	x	o	x	o	92.0	o	o	o	x	6.0
5101-□AK71	15.0	26.5	6000	o	x	o	o	136.0	o	o	x	o	4.0
5102-□AA71	27.0	9.9	1200	x	x	x	x	46.0	x	x	x	x	11.5
5102-□AC71	27.0	16.5	2000	x	x	x	o	78.0	o	o	x	x	9.5
5102-□AF71	27.0	25.0	3000	o	o	x	o	100.0	x	o	x	o	4.5
5102-□AG71	27.0	31.5	4000	o	x	o	o	136.0	x	o	x	o	4.5
5102-□SF71	34.0	31.5	3000	x	x	o	o	122.0	o	x	x	o	5.5
5102-□SG71	34.0	39.5	4000	o	x	o	o	136.0	o	o	x	o	4.0
5103-□AC71	19.0	12.0	2000	o	x	o	x	60.0	o	o	x	x	9.5
5103-□AF71	19.0	17.5	3000	x	o	x	o	92.0	x	o	o	x	6.5
5103-□AG71	19.0	23.0	4000	x	x	o	o	122.0	o	x	x	o	5.5
5104-□AA71	37.0	14.0	1200	o	x	o	x	60.0	x	x	x	x	11.5
5104-□AC71	37.0	22.5	2000	o	o	x	o	100.0	x	x	o	x	8.0
5104-□AF71	37.0	34.0	3000	o	x	o	o	136.0	o	x	x	o	5.5
5104-□SF71	48.0	44.0	3000	o	x	o	o	136.0	x	o	x	o	4.5
5106-□AA71	45.0	17.0	1200	x	x	x	o	78.0	x	x	x	x	11.5
5106-□AC71	45.0	26.8	2000	x	x	o	o	122.0	x	x	o	x	8.0
5106-□AF71	45.0	42.5	3000	o	o	o	o	200.0	o	x	x	o	5.5
5106-□SF71	57.0	54.0	3000	o	o	o	o	200.0	x	o	x	o	4.5

Definition: o = Contact in the basic OFF setting
x = Contact in the ON setting

- 1) The specified value is the maximum permissible current of the particular power module/motor combination. It may be necessary to reduce the specified value depending on the driven mechanical systems.

Table 1-9 Adaptation table for 6SN112□-1AA00-0FA1 100/200 A power modules, continued

Servomotor				Current limit ¹⁾					Current controller gain				
1FT	M ₀ [Nm]	I ₀ [A]	n _{rated} [RPM]	Contacts				I _{max} [A]	Contacts				Kp(I)
				2	3	4	5		6	7	8	9	
5108-□AA71	55.0	20.5	1200	x	o	x	o	92.0	x	x	x	x	11.5
5108-□AC71	55.0	32.5	2000	o	x	o	o	136.0	x	x	o	x	8.0
5108-□AF71	55.0	50.5	3000	o	o	o	o	200.0	x	o	x	o	4.5
5132-□AA71	60.0	22.5	1200	o	o	x	o	100.0	x	x	x	x	11.5
5132-□AC71	60.0	35.5	2000	x	o	o	o	170.0	o	o	x	x	9.5
5132-□AF71	60.0	47.5	3000	o	o	o	o	200.0	x	o	o	x	6.5
5132-□SA71	70.0	26.0	1200	o	o	x	o	100.0	x	x	x	x	11.5
5132-□SC71	70.0	41.0	2000	x	o	o	o	170.0	o	o	x	x	9.5
5132-□SF71	70.0	55.5	3000	o	o	o	o	200.0	x	o	o	x	6.5
5134-□AA71	75.0	28.0	1200	x	x	o	o	122.0	x	x	x	x	11.5
5134-□AC71	75.0	47.0	2000	o	o	o	o	200.0	x	x	o	x	8.0
5134-□SA71	90.0	34.0	1200	x	x	o	o	122.0	x	x	x	x	11.5
5134-□SC71	90.0	56.0	2000	o	o	o	o	200.0	x	x	o	x	8.0
5136-□AA71	85.0	31.5	1200	o	x	o	o	136.0	x	x	x	x	11.5
5136-□AC71	85.0	47.5	2000	o	o	o	o	200.0	x	x	o	x	8.0
5136-□SA71	110.0	41.0	1200	o	x	o	o	136.0	x	x	x	x	11.5
5136-□SC71	110.0	61.5	2000	o	o	o	o	200.0	x	x	o	x	8.0
5138-□AA71	105.0	39.0	1200	x	o	o	o	170.0	x	x	x	x	11.5
5138-□SA71	140.0	52.0	1200	x	o	o	o	170.0	x	x	x	x	11.5

Definition: o = Contact in the basic OFF setting
 x = Contact in the ON setting

1) The specified value is the maximum permissible current of the particular power module/motor combination. It may be necessary to reduce the specified value depending on the driven mechanical systems.

Speed Controller Optimization

2

VS

The additional smoothing functions in the controller loop (to dampen mechanical resonance points) are described in Section 3. Proceed as follows when optimizing the speed:

1. Tachometer calibration
2. Gain K_p
3. Integral action time T_N
4. Adaptation T_N (if necessary)
5. I component limiting (if necessary)
6. Drif compensation (offset)

The unit must be powered-up to optimize the speed controller, regarding Sections 2.1, 2.2, 2.3 and 2.8. Therefore observe Section 7 "Powering-up".

The potentiometer scaling is defined as follows (in the setting tables):

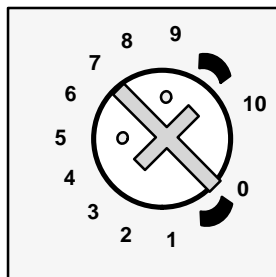

The setting shown in the diagram corresponds to 7 scale sections.

2.1 Tachometer calibration

For motors with a tachometer voltage ≤ 16.5 V, proceed as described in Section 1.1.

Potentiometer	Setting range
	$0.7 n_{\text{rated}} \leq n_{\text{act} N} \leq 2.2 n_{\text{rated}}$

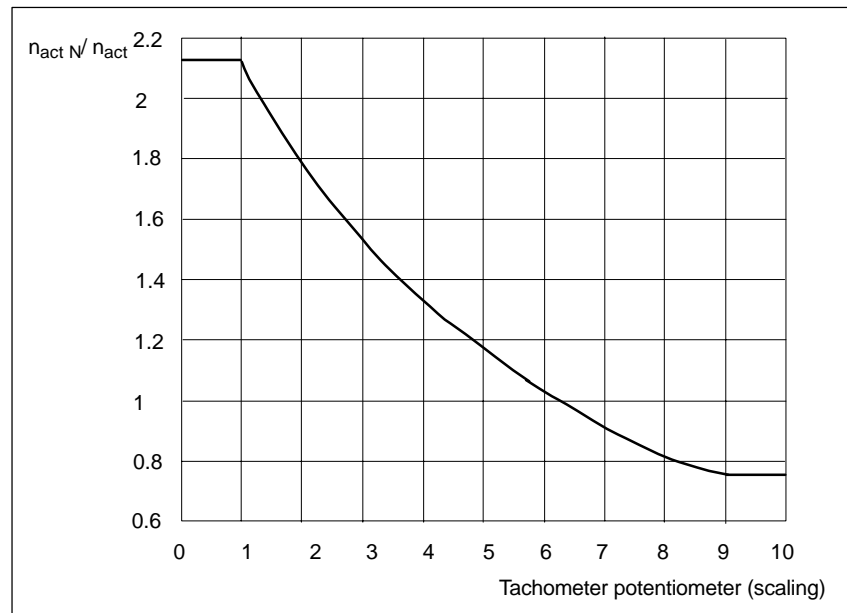

Fig. 2-1 Tachometer calibration

Extended setting range using R3 and R10 (only for the user-friendly interface).

Function	Component	Value
$n_{\text{act} N} > 0.7 n_{\text{rated}}$	Increase R3	0 Ω (as supplied)
$n_{\text{act} N} < 2.2 n_{\text{rated}}$	Insert R10	Open-circuit (as supplied)

2.2 Setting the proportional gain K_p without adaptation

The proportional gain K_p of the speed controller can be set using potentiometer K_p . The range can be extended, if required using a fixed resistor R_{50} (only user-friendly interface; $R_{50} = 68 \text{ k}\Omega$ (when supplied)). The gain, set using the K_p potentiometer is additionally influenced by the setting of the T_N potentiometer.

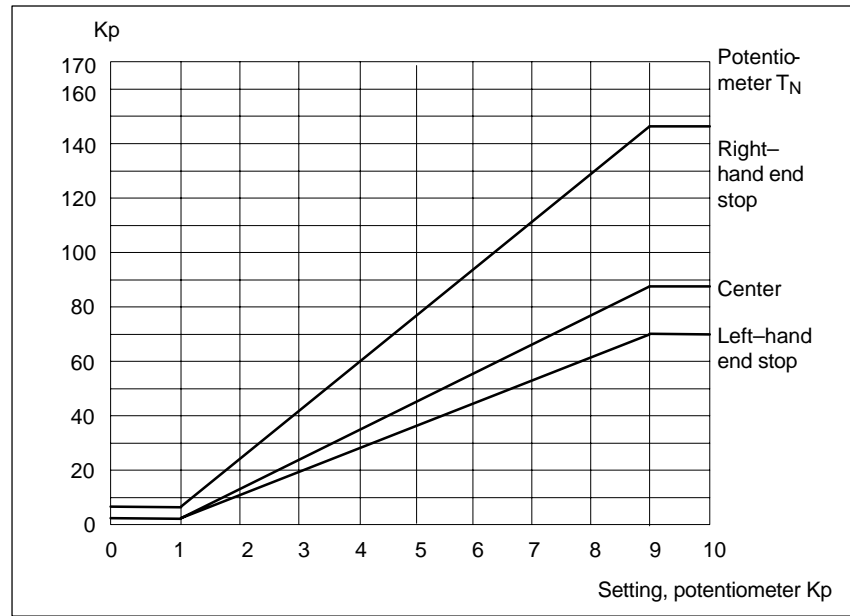

Fig. 2-2 Proportional gain K_p as a function of the K_p potentiometer and T_N potent.

VS

2.3 Setting the integral action time T_N without adaptation

2.3 Setting the integral action time T_N without adaptation

Speed controller integral action time is set using potentiometer T_N , the range can be extended, when required, using C2 (only for the user-friendly interface).

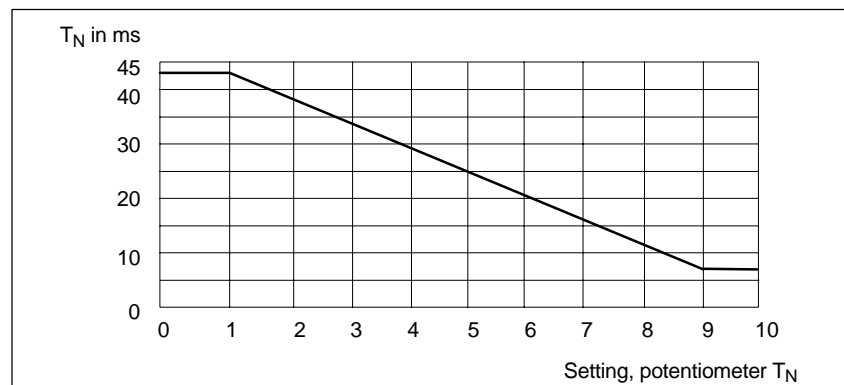

Fig. 2-3 Integral action time T_N as a function of potentiometer T_N

2.4 Integral action time with adaptation (if required)

Resistor R34 (only for the user-friendly interface) or switch S3.5 (S6.5 for the 2nd axis) for the standard interface is used to activate and pre-set the adaptation.

R34 = open R34 = inserted	Adaptation inactive (as supplied) Adaptation operates according to the following diagrams
------------------------------	--

VS

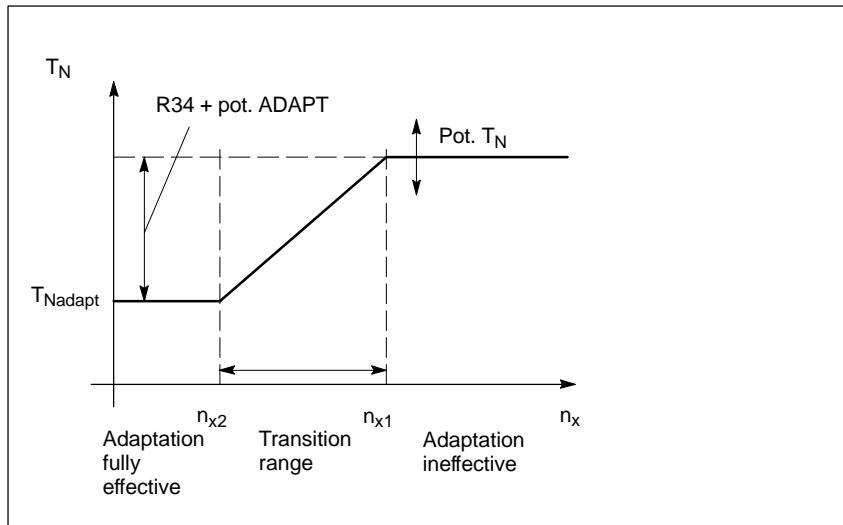

Fig. 2-4 Adaptation of the integral action time

$$n_x = |n_{set} + n_{act}|$$

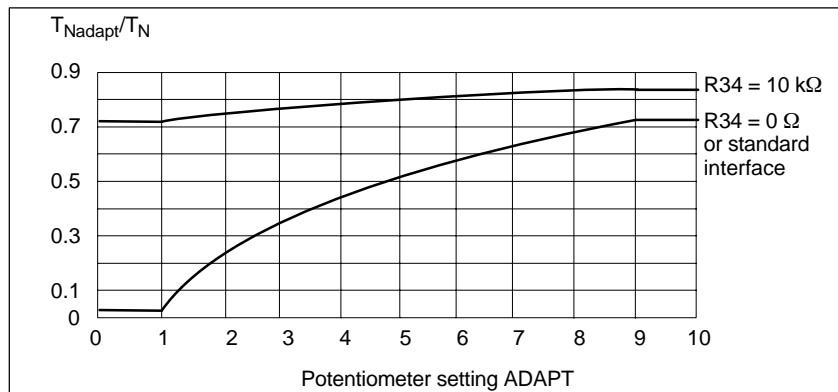

Fig. 2-5 Inter-dependency of adaptation T_N

2.5 P gain with adaptation (only user-friendly interface)



Important

Offsets can occur in the transition range.

R38 is used to activate and pre-set adaptation (if required):

R38 = open R38 = inserted	Adaptation inactive (as supplied) Adaptation operates according to the following diagrams
------------------------------	--

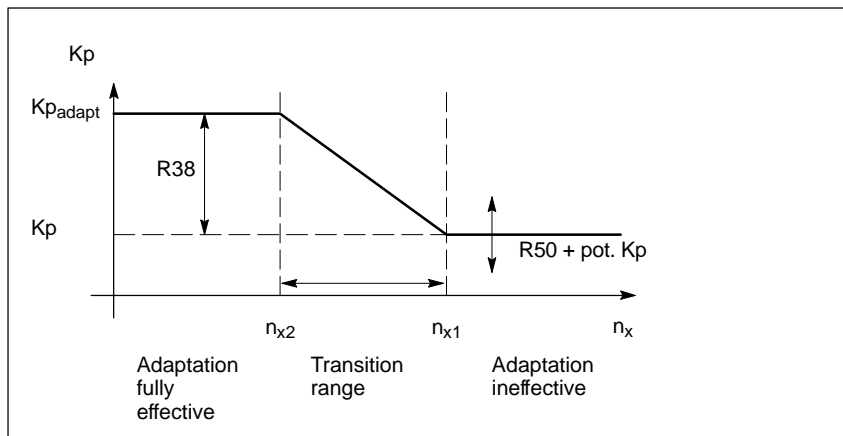

Fig. 2-6 Proportional gain K_p as a function of the speed

$$n_x = |n_{set} + n_{ist}|$$

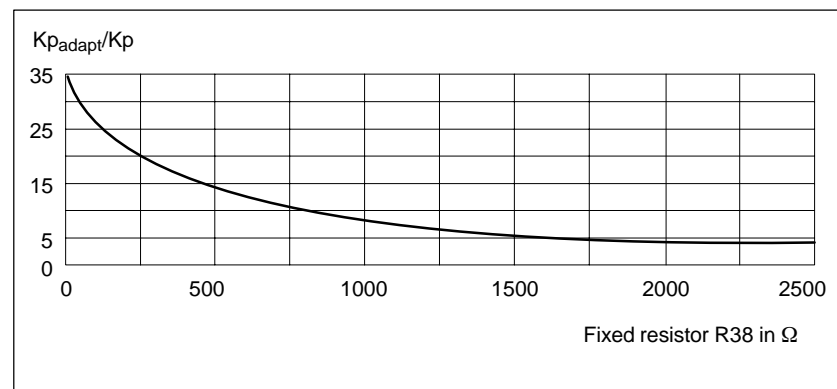

Fig. 2-7 Adaptation K_p as a function of R38 in the "adaptation fully effective" range

2.6 Setting the adaptation range (generally not required)

The adaptation range can be set via the following resistors:

- R40 User-friendly interface
- R543 Standard interface 1st axis (Order No.[MLFB] 6SN1118-0AD11-0AA1)
- R544 Standard interface 2nd axis (Order No.[MLFB] 6SN1118-0AE11-0AA1)

R□ = open	-----	Max. adaptation range (as supplied)
R□ = inserted	—————	Adaptation, reduced acc. to the following diagram

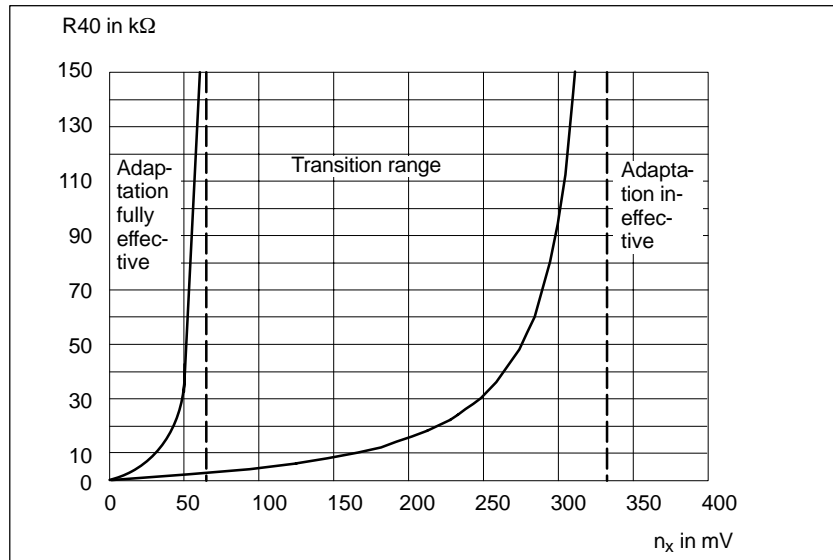

Fig. 2-8 Adaptation range

$$n_x = |n_{set} + n_{act}|$$

2.7 I-component speed controller limiting

- R52 User-friendly interface
- R547 Standard interface, 1st axis (from Order No. 6SN1118-0AD11-0AA1)
- R550 Standard interface, 2nd axis (from Order No. 6SN1118-0AE11-0AA1)

R□ = open-circuit	I-component fully effective (as supplied)
R□ = 0 Ω	I-component, not effective

As limit for the speed controller I component, between 100 kΩ and 2 MΩ can be set for R52, e.g. for slip-stick effects.

2.8 Drift compensation (offset)

This is calibrated using a potentiometer for $n_{set} = 0$ (terminal 56 and terminal 14 short-circuited)

Potentiometer drift	Control range ± 30 mV
---------------------	-----------------------



VS

Supplementary Commissioning Functions

3

3.1 Setting elements with the standard interface

VS

Setting elements, switches S2 and S3 or S5 and S6 for the 2nd axis

Contacts, S2/S5 10 x DIL	OFF	ON
1	Motor, clockwise direction of rotation for a positive speed setpoint (motor shaft drive end) at terminal 56/14	Motor, counter-clockwise direction rotation for a positive speed setpoint (motor shaft drive end) at terminal 56/14
2...5	Current normalization ($I_{\max}=100\%$) ¹⁾	Current normalization ($I_{\max}=23\%$)
6...9	Current controller gain (0.5) ¹⁾	Current controller gain (11.5)
10	Closed-loop speed controlled operation ¹⁾	Closed-loop current controlled operation

Contacts S3/S6 8 x DIL	Function	OFF	ON
1	Speed setpt. smoothing	W/out smoothing ¹⁾	with T= 2.2 ms
2	Speed actual value smoothing	W/out smoothing ¹⁾	with T= 280 μ s
3	Speed contr. smoothing	W/out smoothing ¹⁾	with T= 370 μ s
4	Current setpt. smoothing	W/out smoothing ¹⁾	with T= 110 μ s
5	Speed contr. adaptation	OFF ¹⁾	ON T
6	Ready/fault ²⁾	Ready signal ¹⁾	Fault signal
7	Master/slave ³⁾⁴⁾	Master ¹⁾	Slave ⁴⁾
8	Current-contr. operation	With I component	W/out I component ¹⁾

1) Status as supplied

2) **Important!**

This acts on the BB relay of the NE/monitoring module. If the user-friendly and standard interface are operated together, or the standard interface alone, then if the enable is not present or there is a fault of the standard axes, the BB relay of the NE module drops-out.

3) Function only for a 2-axis version

4) Slave axis must be operated in the closed-loop current controlled mode with enabled I component.

3.1 Setting elements with the standard interface

The following supplementary functions can be set by mounting wired components on the basic board (from Order No.[MLFB] 6SN1118-0AD11-0AA1 (1 axis) or from Order No.[MLFB] 6SN1118-0AE11-0AA1 (2 axes).

Function	BKZ axis1	BKZ axis 2	Value range
Smoothing, speed controller	C231	C235	0 ... 100nF
Smoothing, n_{set}	C232	C236	0 ... 2.2 μ F
Smoothing, n_{act}	C233	C237	0 ... 100nF
Smoothing I_{set}	C234	C238	0 ... 100nF
Timer stage "speed controller at its end-stop"	C239	C240	0 ... 2.2 μ F
Tachometer adaptation	R539, R540, R541	R536, R537, R538	0 ... ∞ k Ω , 0.1%, 25ppm/K
Clock cycle frequency, PBM	R542	R542	62 k Ω ... ∞
Adaptation range	R543	R544	0 ... ∞ k Ω
Speed setpoint adaptation	R545	R546	0 ... ∞ k Ω
Limit, speed controller I-component	R547	R550	\sim 100 k Ω ... 2 M Ω
Electr. weight equalization pos./neg.	R548/R549	R551/R552	20 k Ω ... ∞
Response threshold I^2t monitoring	R553	R554	0 ... ∞ k Ω

Axial metal film resistors, packaging type 0204 (RM 7.62 mm) or radial MKT capacitors (RM 5.08 mm) should be mounted at the mounting locations provided. When adapting the tachometer, it should be noted that the (3) resistors have a relative accuracy of 0.1% with respect to one another and a Tk of < 25 ppm/K.

Note

The board can be damaged if incorrect materials are used.

Important

Only trained personnel may carry-out any soldering work on the board (maintaining the ESD Guidelines).

3.1.1 Dimensioning the setting elements (Standard interface)

a) Smoothing functions

Speed controller: $T=C231(C235) \cdot 78 \text{ k}\Omega$

n_{set} : $T=C232(C236) \cdot 10 \text{ k}\Omega$

n_{act} : $T=C233(C236) \cdot \sim 10 \text{ k}\Omega$ (dep. on the tacho. pot. setting)

l_{set} : $T=C234(C238) \cdot 5 \text{ k}\Omega$

b) Timer, "speed controller at its endstop"

The monitoring time is, as standard 230 ms, and when required can be increased by mounting C239 (C240). In this case, the following relationship exists:

$$T_{\text{Zst}} = \left(1.15 + \frac{C239 (C240)}{\mu\text{F}} \right) \cdot 200 \text{ ms}$$

c) Tachometer adaptation

The following equivalent circuit diagram is valid for the individual tachometer voltages:

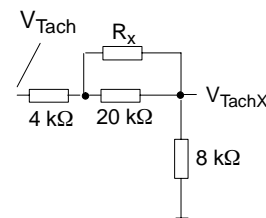

The tachometer voltage V_{Tach} is generally 40 V at rated speed, which provides a voltage V_{TachX} of 10 V. Different values can be used corresponding to this criteria for a rated motor speed which deviates significantly from the useful speed. The following formula applies:

$$R_x = \frac{[5 \cdot \text{k}\Omega \cdot (V_{\text{Tach}} / V_{\text{TachX}}) - 7.5 \text{ k}\Omega]}{1 - \frac{1}{4} \cdot (V_{\text{Tach}} / V_{\text{TachX}})}$$

d) Clock cycle frequency PBM

If noise problems develop (a motor which whistles), the clock cycle frequency of the PWM inverter can be adapted for both axes together (Fig. 3-1).

However, it must be taken into account that the available current (I_n , I_{max}) is reduced when the clock cycle freq. is increased (ref. to PJU Section 4.1).

The I^2t limiting is designed for a factory-set pulse frequency of 3.3 kHz and a max. ambient temperature of 40°C. If these values are exceeded (pulse frequency and/or ambient temperature), the response threshold must be adapted (refer to Fig. 3-2).

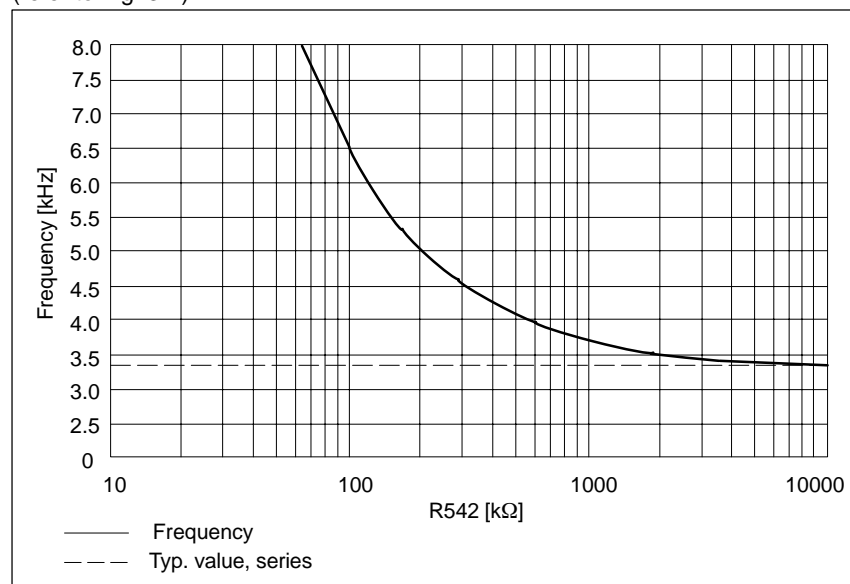
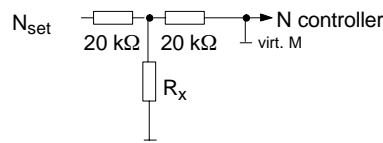

Fig. 3-1 Clock-cycle frequency of the PWM inverter

3.1 Setting elements with the standard interface

e) Speed setpoint adaptation

If the adjustment range of the tachometer potentiometer (for low speed ranges) is not sufficient, then the speed setpoint can be adapted using the setpoint voltage divider. The following circuit diagram applies:



The following relationship is obtained for R545 (R546):

$$R_x = 10 \cdot k\Omega \cdot \frac{n_{required}}{n_{rated} - n_{required}}$$

f) Limiting, I component, speed controller (refer to 2.7)

The maximum I component of the speed controller can be limited by inserting R547 (R550).

g) Electronic weight equalization

The value to be set for the electronic weight equalization is obtained from the current setpoint I_{setGwa} , which can be measured at test socket T with the axis enbled at standstill ($N_{set}=0$):

$$R = \frac{10 \cdot V}{I_{setGwa}} \cdot 10 \cdot k\Omega \quad \text{Caution: } I_{setGwa} \leq 5V \Rightarrow R \geq 20 \text{ k}\Omega!$$

After the resistor has been inserted, the value, with the axis inhibited, must be able to be measured at test socket T with the same sign (polarity).

h) Response threshold I²t monitoring

The I²t monitoring limits the current setpoint to the thermally permissible value. The response threshold is 55% of the peak power module current, and can be reduced, corresponding to the following characteristic by inserting R553 (R554):

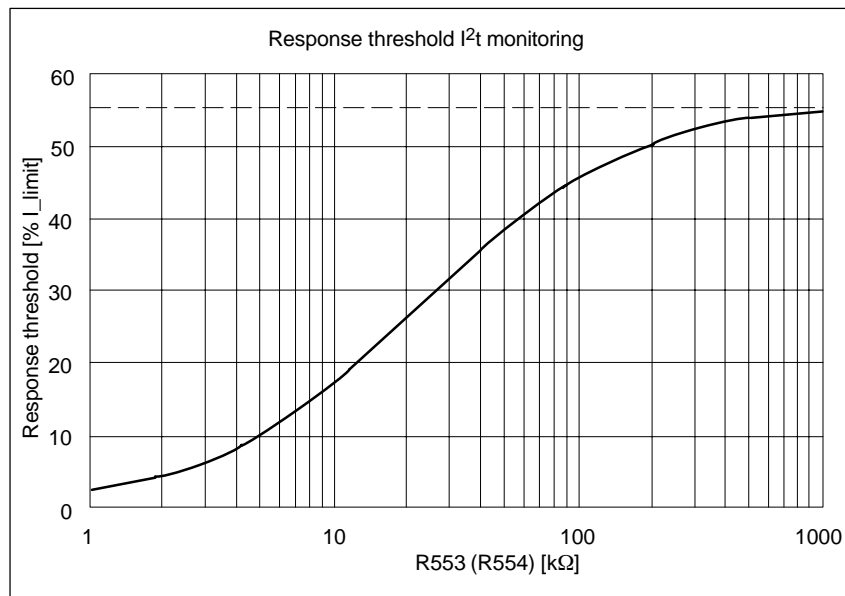

Fig. 3-2 Response threshold I²t monitoring

3.2 Setting elements with user-friendly interface

Setting elements on the parameter board;
Terminal = H → connected to terminal 9, terminal = L → open-circuit.

Function	Component(s)	Effect
Ready/fault relay terminal 672/673/674	R33 = 0 Ω (as supplied) R33 = open	Ready signal Fault signal
Speed/current control (permanently set via switch)	S2: 10 = OFF (as supplied) S2: 10 = ON	Speed-controlled Current-controlled
Speed/current controlled (selected via terminal)	R14 = 0 Ω ¹⁾ ; Term.22 = L R14 = 0 Ω; Term.22 = H	Speed-controlled Current-controlled
Supplementary setpoint 1 via terminal 22 = H	R17 (as supplied = open) ²⁾ R16 (as supplied = open) R18 (as supplied = open)	Voltage divider at 10 V Voltage divider at -10 V Voltage divider at the reference point
Supplementary setpoint 2 via terminal 23 = H	R21 (as supplied = open) ²⁾ R19 (as supplied = open) R22 (as supplied = open)	Voltage divider at 10 V Voltage divider at -10 V Voltage divider at the reference point
Current-controlled operation with/without I component	R1 = 0 Ω (as supplied) R1 = open	I component inhibited P I component active PI
Controller and pulse inhibit via term. 65	R13 = open (as supplied) R13 = 0 Ω	Delayed Instantaneous
Master-/slave oper.: master operation slave operation	R42 + R44 = 0 Ω, S2: 10 = OFF R44 = 0 Ω, R1 + R42 = open, S2: 10 = ON	Master operation, term. 258 = output Slave operation, term. 258 = input
Timer, speed controller at its endstop	R54 = 360 kΩ (as supplied) R54, as selected	t = 230 ms $R54 [k\Omega] = \frac{t [ms]}{0.56} - 47$
Monitoring, speed controller at its endstop	R32 = 0 Ω (as supplied) R32 = open	Monitoring active Monitoring inactive
Direction of rotation reversal (direction of rotation for a positive setpoint at terminal 56/14)	S2: 1 = ON (as supplied) S2: 1 = OFF	Motor counter-clockwise rotation, motor drive shaft end Motor clockwise direction of rotation, motor drive shaft end
Speed controller smoothing	C3 (as supplied = open)	$\tau = C3 \cdot 68 \text{ k}\Omega$
Speed setpoint smoothing	C4 (as supplied = open)	$\tau = C4 \cdot 10 \text{ k}\Omega$
Speed actual value smoothing	C5 (as supplied = open)	$\tau = C5 \cdot 5 \text{ k}\Omega$
Current setpoint smoothing	C6 (as supplied = open)	$\tau = C6 \cdot 1 \text{ k}\Omega$
Speed setpoint adaptation ²⁾ (only terminal 56/14)	R5 = 20 kΩ (as supplied)	$ 100\% \cdot n_{ACT N} = 11 \dots 5V$
Current setpoint adaptation	R42 (as supplied = 0 Ω) ²⁾	$I_{set} < 10 \text{ V}$
Travel to fixed endstop (fixed setting via R12)	R12 acc. to Fig. 3-3 Condition: term. 96 connected to terminal 44	Limiting according to Fig. 3-3 speed controller monitoring inactive

1) As supplied: R14 = open

2) $R = \frac{N_{set}}{10 \text{ V}} \cdot \left(\frac{N_{rated}}{N_{max}} - 0.5 \right) \cdot 40 \cdot \text{k}\Omega$

3.2 Setting elements with user-friendly interface

Function	Component(s)	Effect
Travel to fixed endstop (variable via term. 96)	R12 = open (as supplied) Volt. at term. 96 acc. to Fig. 3-4	Limiting acc. to Fig. 3-4, Speed controller monitoring inactive
Setting-up operation (central via term. 112 on the NE module)	R12 acc. to Fig. 3-3 KL112 = open (as supplied term. 112 connected to terminal 9)	Limiting acc. to Fig. 3-3, Speed controller monitoring inactive
Current reduction after the timer, speed controller at end-stop, has expired	R2 acc. to Fig. 3-5 R32 = open	Reduction, acc. to Fig. 3-5 speed controller monitoring disabled
Current reduction after the I ² t timer has expired	R2 = open (as supplied) R32 = open	S1 duty = 1.1 I _{rated}
Response threshold I ² t	R9 = 30 kΩ (as supplied) R9 acc. to Fig. 3-6	S1 duty = 1.1 I _{rated} Limiting, acc. to 3-6
Electronic weight equalization	R46 + R48 = open (as supplied) R46 for neg. I-set at socket T R48 for pos. I-set at socket T	No weight equalization Supplementary I set according to Fig. 3-7 Supplementary I set according to Fig. 3-7
Tachometer adaptation ¹⁾	R6, R7, R8 tolerance ≤ 0.1%	$R_x = \frac{[5 \text{ k}\Omega \cdot (V_{Tach} / U_{TachX}) - 7.5 \text{ k}\Omega]}{1 - \frac{1}{4} \cdot (V_{Tach} / V_{TachX})}$
Clock cycle frequency	R542	Refer to Fig. 3-1

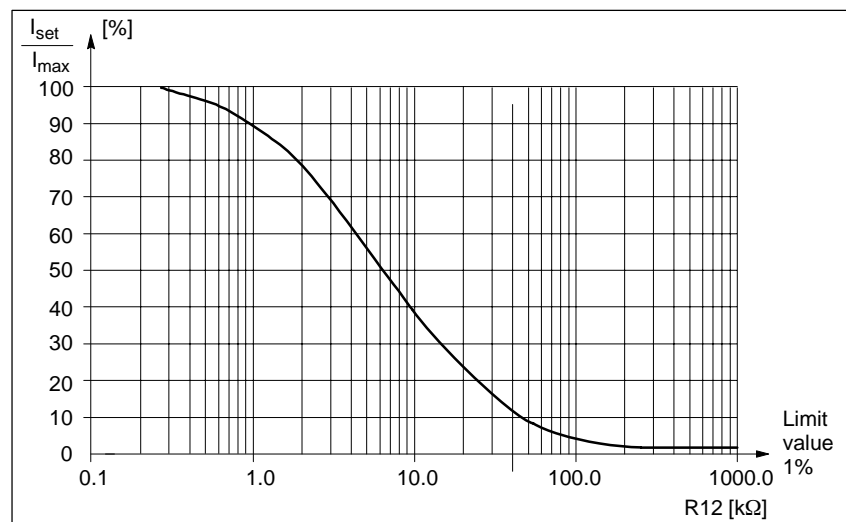

Fig. 3-3 Current setpoint limiting as a function of R12, |30 V| ≥ terminal 96 ≥ |12 V|

1) refer to VS/Section 3.1.1

VS

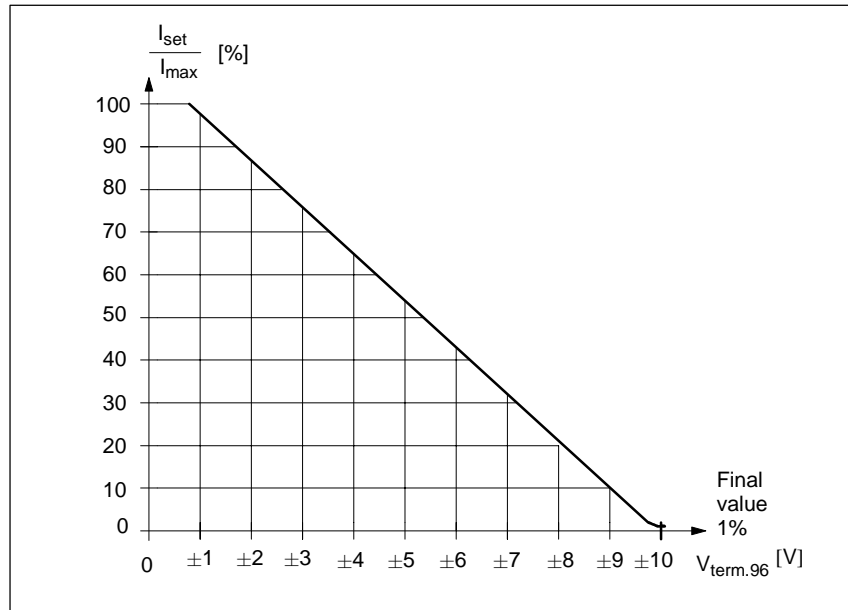

Fig. 3-4 Current setpoint limiting as a function of the voltage at 96 (R12 = open)

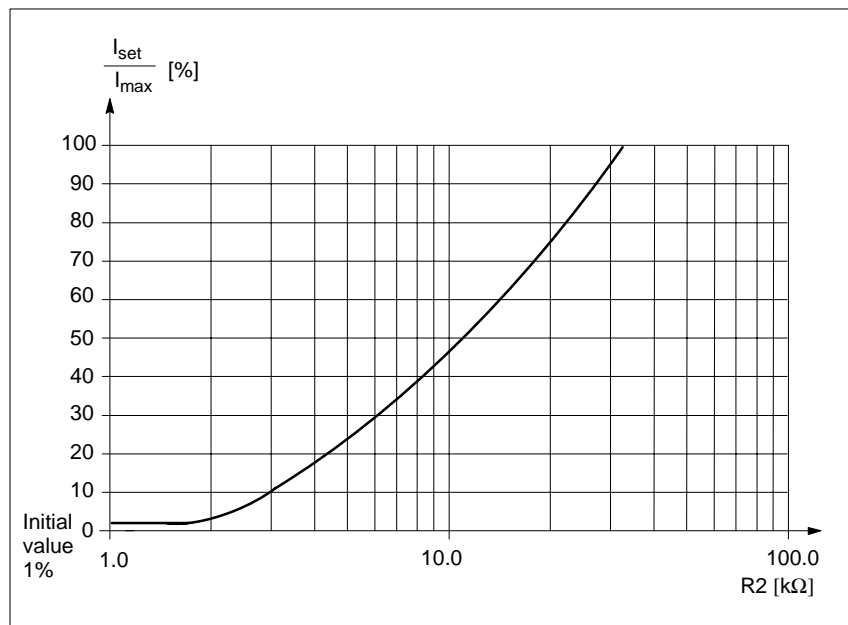

Fig. 3-5 Current setpoint limiting as a function of R2

3.2 Setting elements with user-friendly interface

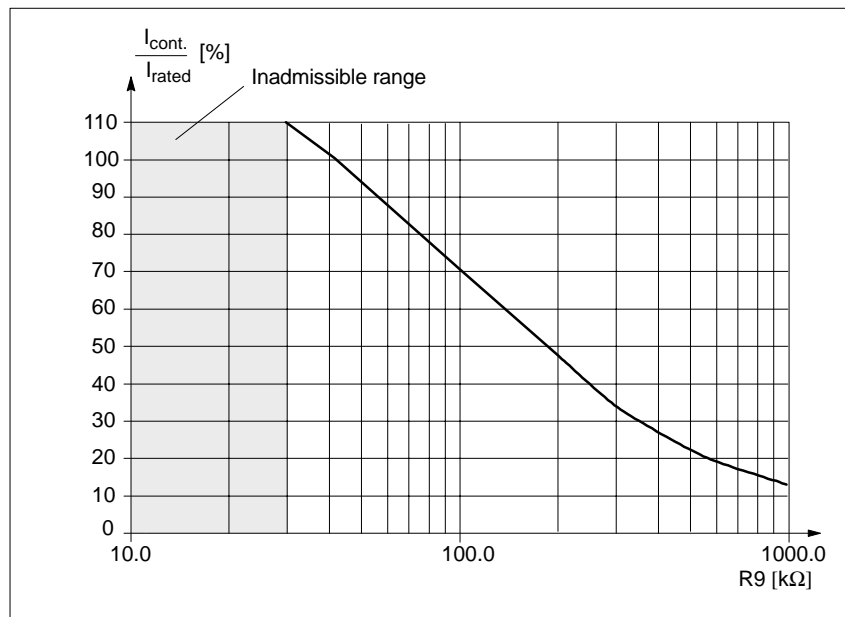

Fig. 3-6 Response threshold, I²t monitoring as a function of R9

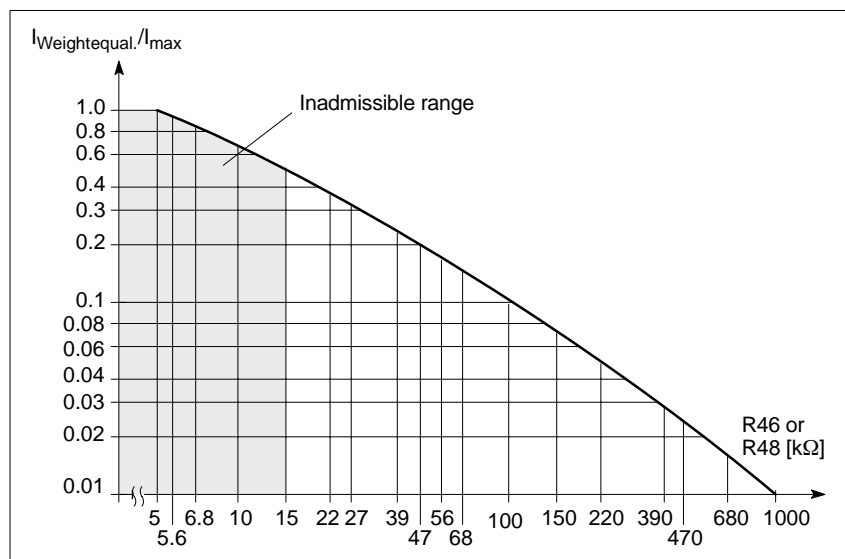

Fig. 3-7 Supplementary current setpoint for electronic weight equalization

Inverter clock cycle frequency PBM

When noise problems develop (the motor makes a whistling sound), the clock cycle frequency of the PWM inverter can be changed by inserting R369 on the basic board.

However, it should be noted, that the available current (I_n , I_{max}) is reduced when the clock cycle frequency is increased (refer to PJU Section 4.1)

The I²t limiting is designed for a factory-set pulse frequency of 3.3 kHz and a max. ambient temperature of 40 °C. If this value is exceeded (pulse frequency and/or ambient temperature), the response threshold must be changed (refer to Fig. 3-2). The characteristic according to Fig. 3-1 applies.



Setpoint Interfaces

4

VS

Definitions:

- Optimum, taking into account the properties of the setpoint input
- Possible
- Not permitted, also in some cases not possible

Table 4-1 Main setpoint – supplementary setpoints

Operating mode	Setpoint	Terminal 56/14	Terminal 24/20	Int. setpoint term. 22	Int. setpoint term. 23	Socket NZ	Terminal 258
Speed controlled	Main setpoint	X					
	Suppl. setpoint		X	X	X	X	
Current controlled	Main setpoint		X				
	Suppl. setpoint			X			
Slave I controlled current setpoint input	Main setpoint						X
	Suppl. setpoint						
MSD option MSD operation	Main setpoint	X					
	Suppl. setpoint						
MSD option C axis	Main setpoint		X				
	Suppl. setpoint			X	X		

Table 4-2 Motor direction of rotation for a positive setpoint and S2.1 = ON

Mode	Term. 56/14	Term. 24/20	Term. 22	Term. 23	Socket NZ	Master/slave Term. 258
Speed-controlled	Left	Right	R16/18 right	R19/22 right	Left	
			R17/18 left	R21/22 left		
Current-controlled		Right	R16/18 right	R19/22 right		Right (slave)
			R17/18 left	R21/22 left		

When viewing the motor shaft drive end



Space for notes

Commissioning with the MSD Option

5

Control parameter settings for C-axis operation on the parameter board, control parameters for MSD operation on the option board.

The components which can be modified for the MSD option are mounted on solder pins (layout, refer to Section 9).

The scale divisions of the potentiometers (in the setting tables) are defined as follows:

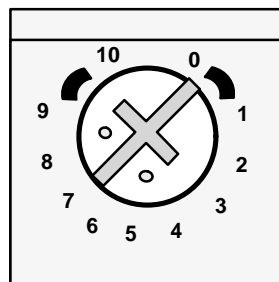

The setting shown in the diagram corresponds to 7 scale units.

VS

5.1 Pre-settings



Warning

Changes on the parameter board: Remove R4, R5 and R54, if required, C4 (not mounted when supplied).

Undesirable axis motion can occur if this information is not observed!

5.1.1 Settings with the control board withdrawn

Ramp-up time

Table 5-1 Ramp-up time from 0 V to 10 V in s via terminal 56/14, setting via potentiometer R20 and terminal 102

	0	1	2	3	4	5	6	7	8	9	10
Terminal 102 open	0.01	0.11	0.21	0.31	0.4	0.5	0.6	0.7	0.8	0.9	1.11
Terminal 102 at terminal 9	0.1	1.08	2.07	3.06	4.04	5.03	6.02	7.01	8.01	9.04	11.05

The ramp-up time range via R20 can be changed by modifying R27/R60.

5.1 Pre-settings

Torque limiting

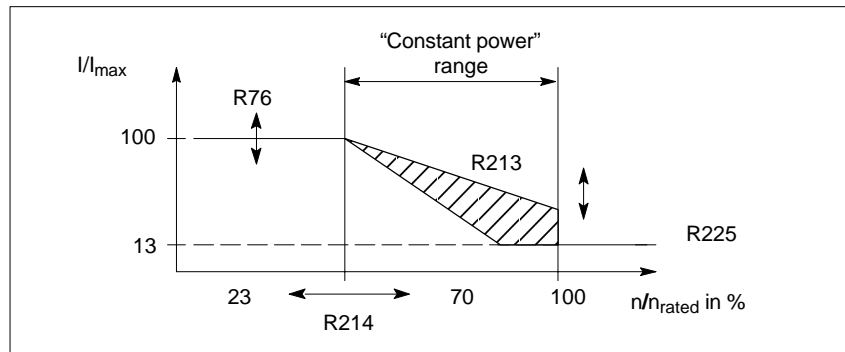

Fig. 5-1 Torque limiting

Table 5-2 Suitable start of the "constant power" range referred to $n_{max} = \pm 10 V$ in % via R214

Potentiometer R214	0	1	2	3	4	5	6	7	8	9	10
Start of the range in %	70	65	60	55	50	45	40	35	30	26	22

Table 5-3 Deviations of the selected power to the constant power at the point n_{max} in % via R213

Potentiometer R213	0	1	2	3	4	5	6	7	8	9	10
Start of the range in %	+20					0					-20

Table 5-4 Constant torque limiting I_{set}/I_{max} in % via R76 (solder pins), R76 is open when the equipment is supplied

R76 in kΩ	3	4.3	6.2	8.2	11	15	18	22	27	≥36
I_{set}/I_{max} in %	10	20	30	40	50	60	70	80	90	100

Intermediate values are determined using interpolation

Table 5-5 Speed-dependent torque limiting I_{set}/I_{max} in % via R225 (solder pins) for R226 = 20 kΩ

R225 in kΩ	2.4	4.7	7.5	11	16	22	30	47	70	100
I_{set}/I_{max} in %	1	10	20	30	40	50	60	70	80	85

12% I_{set}/I_{max} is set as standard. Intermediate values are obtained using interpolation.

Normalization of the |M/P| display

Table 5-6 Normalization via potentiometer R903 (as supplied, factor = 1)

Pot. R903	0	1	2	3	4	5	6	7	8	9	10
Normalization factor	3	2.8	2.6	2.4	2.2	2.0	1.8	1.6	1.4	1.2	1

Relay function, output of two limit value stages

The terminal is selected using 0 Ω resistors

VS

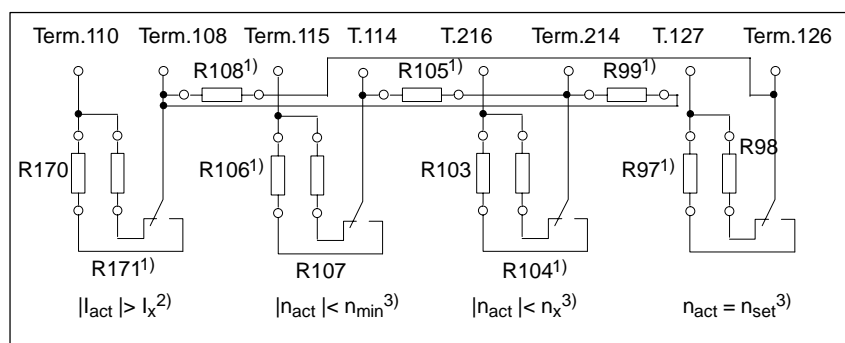

Fig. 5-2 Relay functions

- 1) As supplied
- 2) Relay drops-out
- 3) Relay pulss-in if the function is fulfilled.

5.1 Pre-settings

Table 5-7 Limit value functions

Limit value stage	Range					Settings via fixed values					
$ I_{act} > I_x$ Pot. R211	4.5 %...100 %					Smoothing for relay bounce = C87 Suppression: n_{set} step > 31 mV, R180 = 0 Ω hysteresis = 10 mV, R179 = 2 k Ω					
Pot. R211	0	1	2	3	4	5	6	7	8	9	10
$I_x = in$ %	100	90	81	71	62	52	43	33	24	14	4.5
$ n_{act} < n_{mi}$ n Pot. R10	0.3 %...1.7 % n_{max}					Smoothing for relay bounce = C68, Hysteresis 400 mV (as supplied), Inactive for C axis: R100 = 0 Ω (as supplied) R274 = 300 k Ω corr. to 20 mV hysteresis					
Pot. R10	0	1	2	3	4	5	6	7	8	9	10
$n_{min} = in$ %	0.3	0.44	0.58	0.73	0.87	1.02	1.16	1.31	1.45	1.59	1.74
$ n_{act} < n_x$ Pot. R43	3 %...100 % n_{max}					Smoothing for relay bounce = C68					
Pot. R43	0	1	2	3	4	5	6	7	8	9	10
$n_x = in$ %	3.4	13	23	34	44	54	64	74	84	94	104
$n_{set} = n_{set}^*$	Only in MSD operation					Monitoring threshold: $n_{set} - diff < 20$ mV, R179 = 2 k Ω Hysteresis = 10 mV, R180 = 0 Ω Extension = 32 ms, C20 = 1 μ F					

Functions via fixed values

Table 5-8 Settings via fixed values

Function	Component(s)	Effect
Ramp-function generator tracking	R270 = 0 Ω (as supplied) R270 = open	Tracking active Tracking inactive
Speed setpoint smoothing	C40	τ [ms] = 10 · C40 [μ F]
Correction setpoint for MSD operation (Terminal 65 brakes to the setpoint terminal 24) ²⁾	R900 + R901 = open (as supplied) R900 + 901 = 40 k Ω	No correction setpoint Correction setpoint via term. 24/20
Current actual value/power display	R160 = open, R207 = 1 k Ω (as supplied) R160 = 1 k Ω , R207 = open	M/P display $ I_{act} $ display
C axis/MSD operation Setpoint MSD: term. 56/14 Setpoint C axis: term.24/20 or Fixed setpt. via term. 22 or term. 23	Terminal 61 = open Terminal 61 at terminal 9	MSD operation C axis operation Changeover, refer to Fig. 5-3
Changeover speed, term. 61	R77/78	1)

1) Changeover speed =
$$\frac{R77 \cdot (47000 - R78 \cdot 15)}{R77 \cdot 47 \text{ k}\Omega + R78 \cdot (R77 + 47 \text{ k}\Omega)} \text{ [%]}$$

2)  **Warning:** The pulses are only cancelled after the n_{off} threshold has been fallen below!

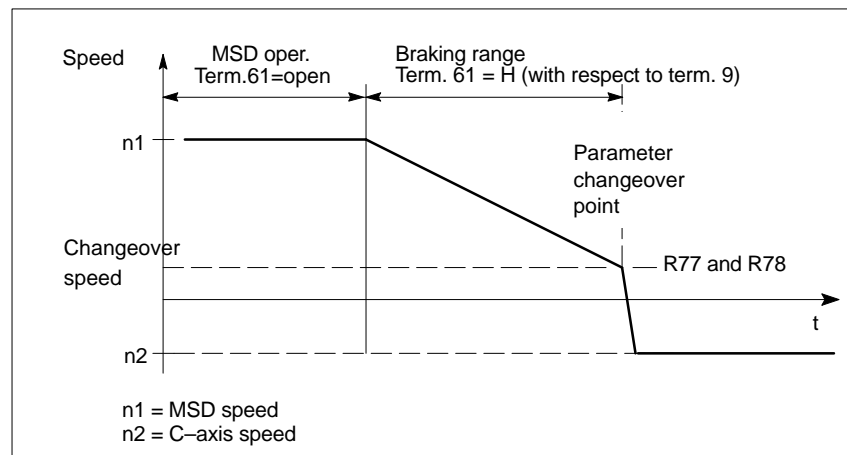

Fig. 5-3 Changeover, terminal 61

Changing-over parameters for C-axis operation

- Control parameters, drift setting, setpoint input
- Adaptation enable
- Switch-in 200 ms timer stage
- Inhibit several relay functions
- Inhibit the n_{off} shutdown

5.1.2 Settings in operation

Setting rule

1. The C axis parameters are set on the parameter board (tachometer, T_N , K_P , drift).
C-axis parameters, refer to the speed controller optimization, VS/Section 2
2. MSD parameters are set using potentiometers located at the front of the option board:

Pot. R44	0	1	2	3	4	5	6	7	8	9	10
Pot. R35=left	2	▶									1
Pot. R35=right	15										1

Fig. 5-4 Extending the integral action time using potentiometer R44 and the influence of potentiometer R35 on the parameter board, T_N extended by a factor

5.1 Pre-settings

Table 5-9 Reducing the proportional gain using potentiometer R45 and the influence of potentiometer R25 on the parameter board, Kp reduction in %

Pot. R45		0	1	2	3	4	5	6	7	8	9	10
Pot. R25	left	33.1	29.5	26.3	23.3	20.4	17.5	14.6	11.5	8.2	4.5	0.1
	center	90.9	89.4	87.8	85.9	83.7	81	77.5	72.4	64.4	48.7	1.5
	right	95.1	94.3	93.3	92.3	90.9	89.3	87	83.7	77.9	65	2.8

Table 5-10 Lowest speed before the controller and pulse inhibit (braking to n_{off} for terminal 64/65 → pulse cancellation) via potentiometer R1

	0	1	2	3	4	5	6	7	8	9	10
n_{off} as % of n_{max}	0.34	0.47	0.61	0.74	0.88	1.02	1.15	1.29	1.42	1.56	1.69

Table 5-11 Drift compensation using potentiometer R96 for $n_{set} = 0$

Potentiometer R96	Control range ± 30 mV
-------------------	---------------------------

5.2 Analog outputs

Function	Terminal	Limitation
Speed actual value	Term. 75	Non-normalized speed actual value such as test socket "X"
Power display (utilization)	Term. 162	M/P display (as supplied) Fig. 5-5, display M/P , Table 5-6, normalization
Current actual value	Term. 162	$ I_{act} $ display by changing-over components (Table 5-8, settings via fixed values)

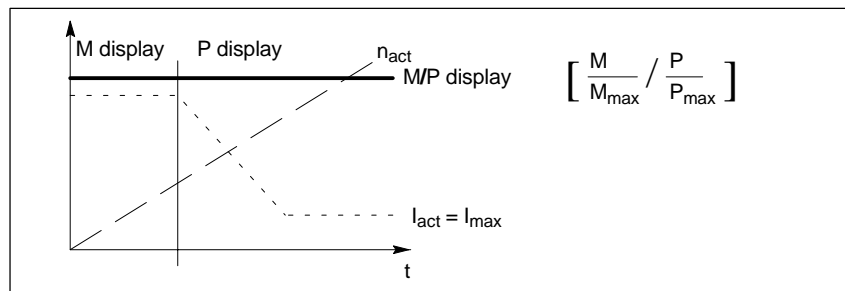

Fig. 5-5 Display |M/P|

VS

Free for Expansions

6



VS

7

Powering-Up

VS

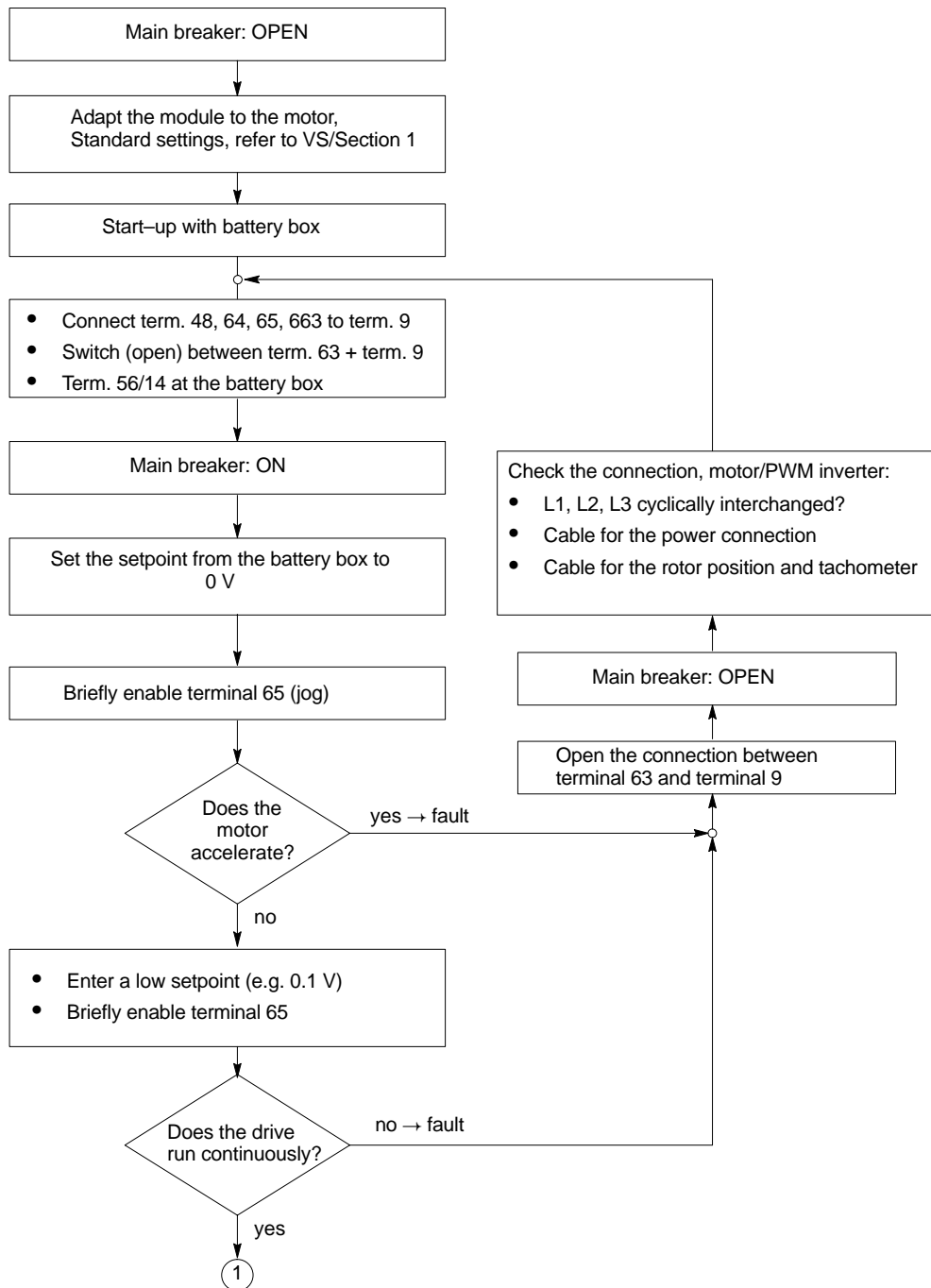

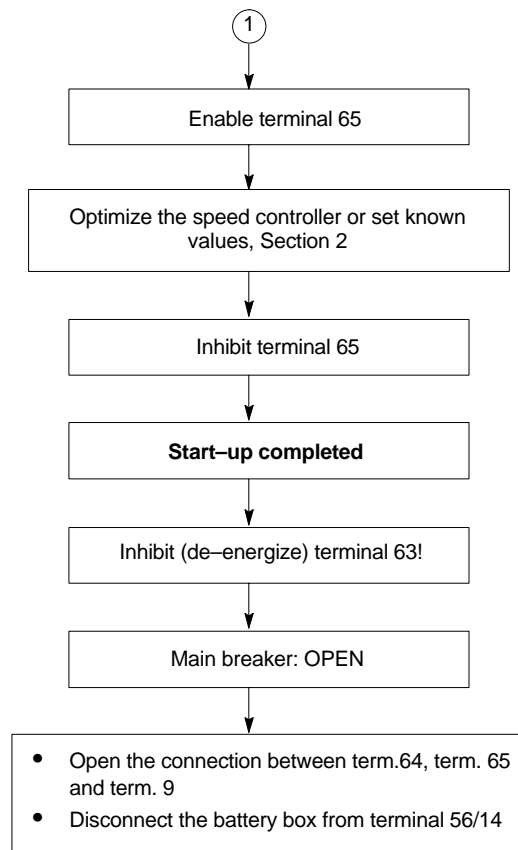

Service and Diagnostics

8

8.1 Test sockets and display elements of the feed modules

VS

8.1.1 User-friendly interface

Test sockets

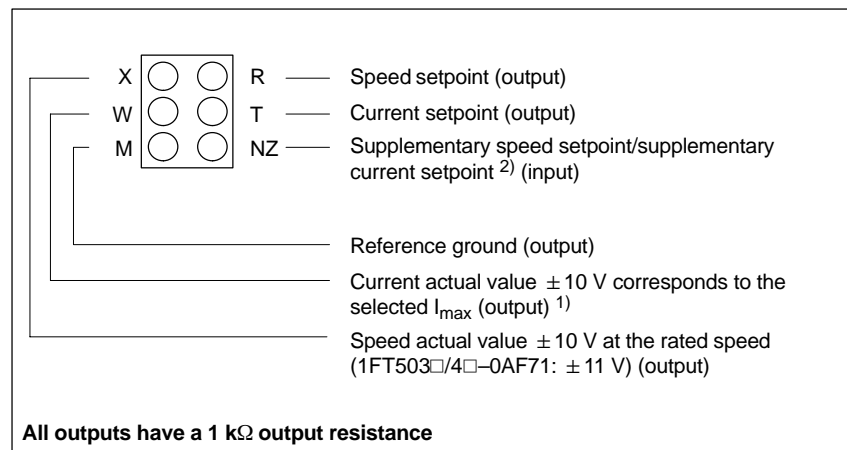

Fig. 8-1 Test sockets, user-friendly interface

Operating display

Par. board inserted	no	yes	yes	yes	yes	yes
Pulse enable 663	–	no	no	yes	yes	yes
Controller enable 65	–	no	yes	no	yes	yes
Current controlled	no	no	no	no	no	yes

Closed-loop speed controlled operation (standard operation)

1) Setting value I_{max} , refer to VS/Section 1.2

2) Closed-loop speed/current controlled depending on the operating mode

8.1 Test sockets and display elements of the feed modules

Fault display

Faule	1	2	3	4	5	6	7	8
I ² t monitoring or heatsink overtemperature	X				X			
Rotor position encoder		X						
Speed controller at its endstop					X	X	X	
Tachometer monitoring				X				
I _{act} = 0							X	
Motor overtemperature			X					
5 V undervoltage (5 V level faulted)								X
Effect:	Current limiting	Pulse cancellation		Pulse cancellation	Pulse cancellation	Pulse cancellation	Pulse cancellation	Pulse cancellation
Signal NE:	T. 5.x	–	T. 5.x	–	–	–	–	–
Signal FD:	T. 291	T. 297+ T. 672/ T. 674	T. 5.x T. 294	T. 297+ T. 672/ T. 674	T. 672/ T. 674	T. 288+ T. 672/ T. 674	T. 288+ T. 672/ T. 674	T. 672/ T. 674 ¹⁾

Sequence when the temperature or I²t monitoring responds

- **I²t monitoring:**
 - min. 250 ms before the limiting becomes active, a pre-alarm is output at terminal 5.x of the NE module (this is not saved)
 - when the limiting becomes active, fault 1 is displayed and a signal is output at term. 291 (saved)
- **Heatsink overtemperature monitoring:**
 - when the heatsink shutdown temperature is reached, a pre-alarm is output at terminal 5.x of the NE module (this is not saved)
 - after typ. 4 s, the pulses are inhibited, fault 1 is displayed and a signal is output at terminal 291 + terminal 672/terminal 674 (this is saved)

Motor overtemperature

The SIMODRIVE 611 feed modules with closed-loop control for 1FT5 servomotors are equipped with an evaluation circuit for the PTC thermistors integrated in the motor windings.

The monitoring combination is intended to protect the motors against inadmissibly high winding temperatures (trip temperature, 150 °C).

As the drive shouldn't randomly intervene in the machining process, when the response temperature is reached, this is only output as signal (no trip) at the SIMODRIVE 611 via the single fault signal, terminals 289/294/296 (this is saved) or centrally via terminals 5.1, 5.2 and 5.3 of the infeed module (this is saved).

There is no internal system response to protect the motor. In the adaptation control, the user must ensure that there is adequate thermal recovery time for the motor immediately after the signal is output. The motor should, if required, be immediately powered-down.

It is not permissible to delay this.

If the motor is not thermally monitored, then the complete drive could be destroyed when an overload condition develops, or if the drive converter has been overdimensioned.

1) Depending on the operating mode (ready/fault signal)

8.1.2 Standard interface

Test sockets and fault displays

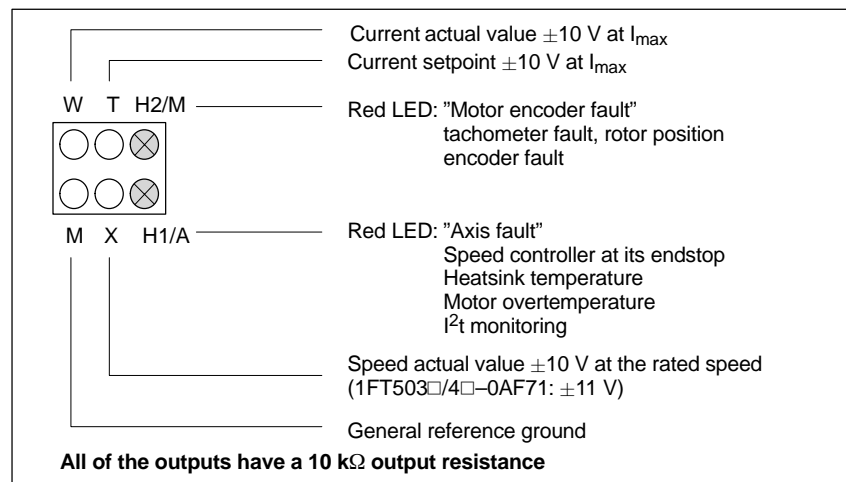

Fig. 8-2 Test sockets, standard interface

Sequence when the temperature or I²t monitoring responds

- **I²t monitoring**
 - A pre-alarm is output at terminal 5.x of the NE module min. 250 ms before the limiting becomes active (this is saved)
 - Fault H1 is displayed when the limiting becomes active.
- **Heatsink temperature monitoring:**
 - When the heatsink shutdown (trip) temperature is reached, a pre-alarm is output at terminal 5.x of the NE module (this is not saved)
 - After typ. 4 s, the pulses are inhibited, fault H1 is displayed and a signal is output at term. 72/term. 73/term. 74 of the NE module (this is saved)

Motor overtemperature

The SIMODRIVE 611 feed modules with closed-loop control for 1FT5 servomotors are equipped with an evaluation circuit for the PTC thermistors integrated in the motor windings.

The monitoring combination is intended to protect the motors against inadmissibly high winding temperatures (trip temperature, 150 °C).

As the drive shouldn't randomly intervene in the machining process, when the response temperature is reached, this is only output as signal (no trip) at the SIMODRIVE 611 or centrally via terminals 5.1, 5.2 and 5.3 of the infeed module (this is saved).

There is no internal system response to protect the motor. In the adaptation control, the user must ensure that there is adequate thermal recovery time for the motor immediately after the signal is output. The motor should, if required, be immediately powered-down.

It is not permissible to delay this.

If the motor is not thermally monitored, then the complete drive could be destroyed when an overload condition develops, or if the drive converter has been overdimensioned.

8.2 Troubleshooting

Table 8-1 Troubleshooting

Fault, user-friendly interface	Fault, standard interface	Possible fault cause
1	H1	RMS torque too high? Ambient temperature > 40 °C?
2	H2	Actual value cable and shield connection correctly connected? Encoder in the motor defective?
3	H1	Motor overloaded, RMS torque too high?
4	H2	Refer to F2
5	H1	Axis mechanically locked? RMS torque too high?
6	H1	Motor incorrectly connected? External moment of inertia too high? RMS torque too high (mechanically locked)?
7	–	Motor feeder cable interrupted, motor cable short-circuit/ground fault (Vce monitoring saved up to POWER-ON) Fault cannot be removed → replace the module
F	–	5V level fault → replace module



9

Attachments

9.1 Terminals

Table 9-1 User-friendly interface

Term. No.	Designation	Function	Type ¹⁾	Type voltage/limit values	Max. cross-section
U2 V2 W2		} Motor connection	O	3-ph. 0...450 V AC	acc. to the Planning Guide
PE1 PE2		Protective conductor Protective conductor	I I	0 V 0 V	Stud Stud
P600 M600	X151/351	DC link (DC link) DC link (DC link) Equipment bus	I/O I/O I/O	+300 V -300 V	Busbar Busbar Ribbon cable
56 14 ²⁾	X321 X321	} Speed setpoint 1 Differential input	I I	0V... ± 10V ⁷⁾	1.5 mm ² 1.5 mm ²
AS1 AS2	X331 X331	➤ Checkb. sig. contact (feedback) Relay, start inhibit	NC	max. 250V _{AC} /1A, 30 V _{DC} /2A	1.5 mm ²
663 9 65 9 22 23	X331 X331 X331 X331 X331 X331	Pulse enable ³⁾ Enable voltage ³⁾⁵⁾ Controller enable ³⁾ Enable voltage ³⁾⁵⁾ Select int. fixed setpoint 1 ³⁾ / current-controlled operation Select in. fixed setpoint 2 ³⁾	I O I O I I	+21...30 V +24 V +13...30 V +24 V +13...30 V +13...30 V	1.5 mm ² 1.5 mm ² 1.5 mm ² 1.5 mm ² 1.5 mm ² 1.5 mm ²
20 ²⁾ 24	X331 X331	➤ Speed setpoint 2/current setpoint Differential input	I I	0V...±10 V (340 μs smoothing) ⁷⁾	1.5 mm ² 1.5 mm ²
96 ⁶⁾ 44 ⁶⁾ 6 ⁶⁾ 258 ⁶⁾ 16 ⁶⁾	X331 X331 X331 X331 X331	Current setpoint limiting Electronics voltage Integrator inhibit, speed controller Current setpoint (master/slave) Norm. current actual value	I O I I/O O	0...±30 V -15 V/10 mA +13...30 V 0 V...±10 V 0 V...±10 V/R _i =1 kΩ	1.5 mm ² 1.5 mm ² 1.5 mm ² 1.5 mm ² 1.5 mm ²
289 288 290 291 293 294 296 297 299	X341 X341 X341 X341 X341 X341 X341 X341 X341	Relay signals, center contact } Speed controller at its endstop } I ² t monitoring } Motor overtemperature } Tacho./rotor pos. encoder fault	I NO NC NO NC NO NC NO NC	4) max. 30 V/1 A max. 30 V/1 A max. 30 V/1 A max. 30 V/1 A max. 30 V/1 A max. 30 V/1 A max. 30 V/1 A max. 30 V/1 A	1.5 mm ² 1.5 mm ² 1.5 mm ² 1.5 mm ² 1.5 mm ² 1.5 mm ² 1.5 mm ² 1.5 mm ² 1.5 mm ²
672 673 674	X341 X341 X341	Ready/fault signal	NO I NC	30 V/1 A ⁴⁾ 30 V/1 A 30 V/1 A	1.5 mm ² 1.5 mm ² 1.5 mm ²
	X311	Motor encoder			

- 1) I=Input, O=Output, NC=NC contact, NO=NO contact (for signal: closed=high, open=low)
- 2) Reference point of the differential input
- 3) Reference ground, terminal19 (this is not connected with the general reference ground, terminal 15)
- 4) Voltage refer to PE potential
- 5) Refer to NE- Section 3.1 ... 3.2
- 6) Reference ground is terminal 15 on the NE module.
- 7) The common mode range of the diff. input is ±24V with respect to PE potential, and this may never be exceeded.

9.1 Terminals

Table 9-2 MSD option (only possible for user-friendly interface)

Term. No.	Designation	Function	Type ¹⁾	Typ. voltage/limit values	Max. cross-section
10 ²⁾	X312	$T_H = 1 : 10$	I	+13 V...30 V/ $R_E = 1.5 \text{ k}\Omega$	1.5 mm ²
61 ²⁾	X312	C-axis operation	I	+13 V...30 V/ $R_E = 1.5 \text{ k}\Omega$	1.5 mm ²
75 ³⁾	X312	n_{act}	O	0 V...±10 V	1.5 mm ²
162 ³⁾	X312	P_{act}/I_{act} ⁵⁾	O	0 V...±10 V	1.5 mm ²
110	X322	} $ I_{act} > I_x$	NO/NC ⁴⁾	30 V/1.0 A max	1.5 mm ²
108	X322		I	30 V/1.0 A max	1.5 mm ²
115	X322	} $ n_{act} < n_{min}$	NO/NC ⁴⁾	30 V/1.0 A max	1.5 mm ²
114	X322		I	30 V/1.0 A max	1.5 mm ²
216	X322	} $ n_{act} < n_x$	NO/NC ⁴⁾	30 V/1.0 A max	1.5 mm ²
214	X322		I	30 V/1.0 A max	1.5 mm ²
127	X322	} $n_{set} = n_{set}^*$	NO/NC ⁴⁾	30 V/1.0 A max	1.5 mm ²
126	X322		I	30 V/1.0 A max	1.5 mm ²

Table 9-3 Standard interface

Term. No.	Designation	Function	Type ¹⁾	Typ. voltage/limit values	Max. cross-section
U2 V2 W2		} Motor connection	O	3-ph. 0...450 V AC	Acc. to the Planning Guide
PE1 PE2			I	0 V	Stud
			I	0 V	Stud
P600 M600	X151/351	DC link	I/O	+300 V	Busbar Busbar Ribbon cable
		DC link	I/O	-300 V	
		Equipment bus	I/O		
AS1 AS2 663 9 ⁶⁾	X321 X321 X321 X321	} Checkb. sig. contact, relay, start inhibit Pulse enable ²⁾ Enable voltage ²⁾	NC	250 V AC/1 A, 30 V DC/2A	1.5 mm ²
			I	+21 V...30 V	1.5 mm ²
			O	+24 V	1.5 mm ²
56.1 14.1 65.1 9 ⁶⁾ 22.1 9 ⁶⁾	X331 X331 X331 X331 X331 X331	} Speed setpoint/current setpoint (differential input) Controller enable ²⁾ Enable voltage ²⁾ Select, I controller ²⁾ Enable voltage ²⁾	I	0 V...±10 V	1.5 mm ² 1.5 mm ² 1.5 mm ² 1.5 mm ² 1.5 mm ² 1.5 mm ²
			I		
			I	+13 V...30 V	
			O	+24 V	
			I	+13 V...30 V	
			O	+24 V	
56.2 14.2 65.2 9 ⁶⁾ 22.2 9 ⁶⁾	X332 X332 X332 X332 X332 X332	} Speed setpoint/current setpoint (differential input) Controller enable ²⁾ Enable voltage ²⁾ Select, I controller ²⁾ Enable voltage ²⁾	I	0 V...±10 V	1.5 mm ² 1.5 mm ² 1.5 mm ² 1.5 mm ² 1.5 mm ² 1.5 mm ²
			I		
			I	+13 V...30 V	
			A	+24 V	
			I	+13 V...30 V	
			A	+24 V	

1) I=Input, O=Output, NC=NC contact, NO=NO contact (for signal: closed=high, open=low)

2) Reference ground term.19 (this is not connected to the general reference ground, terminal 15)

3) Reference ground is terminal 15 at the NE module.

4) Can be optionally changed-over using jumpers

5) The power display is set as standard

6) Refer to NE- Section 3.1 ... 3.2

7) The common mode range of the diff. input is ±24V with respect to PE potential, and this may never be exceeded.

9.2 Layout diagram MSD option board

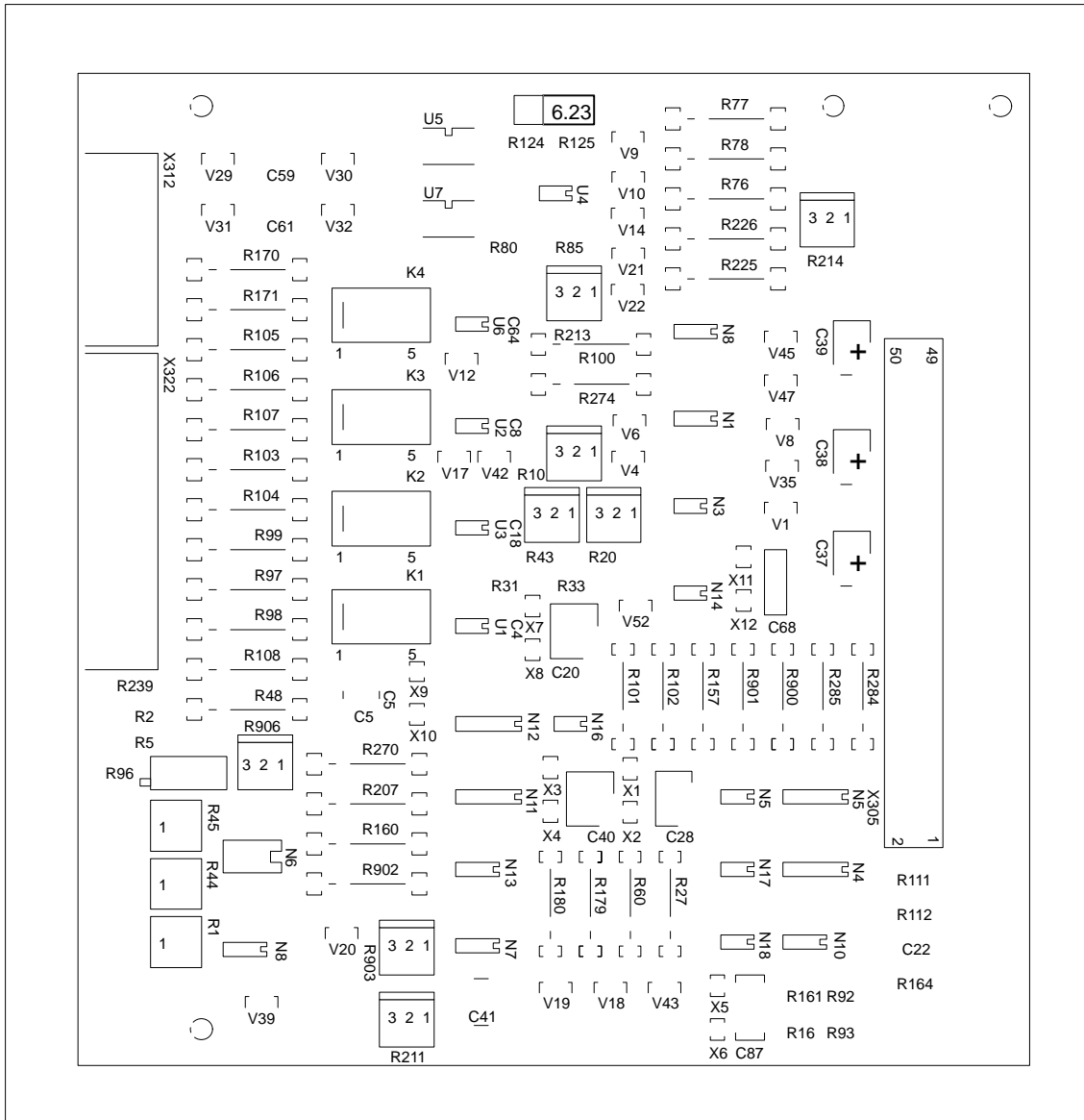

VS

Fig. 9-1 Layout diagram MSD option board

The capacitors are assigned to the adjacent solder pins.

9.3 Layout diagram, parameter board

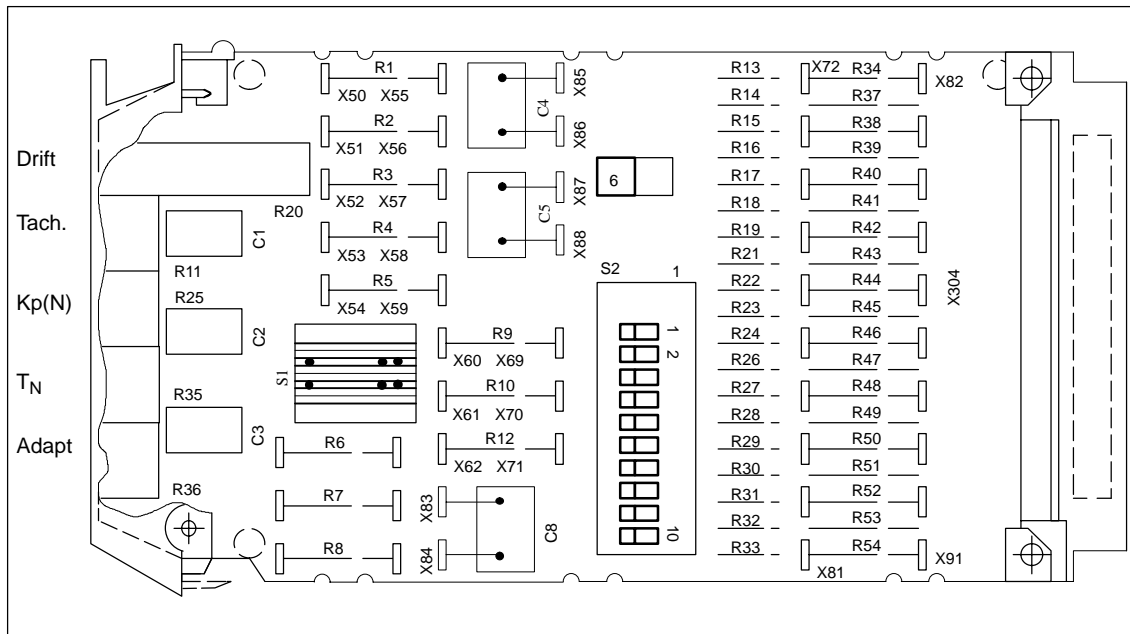
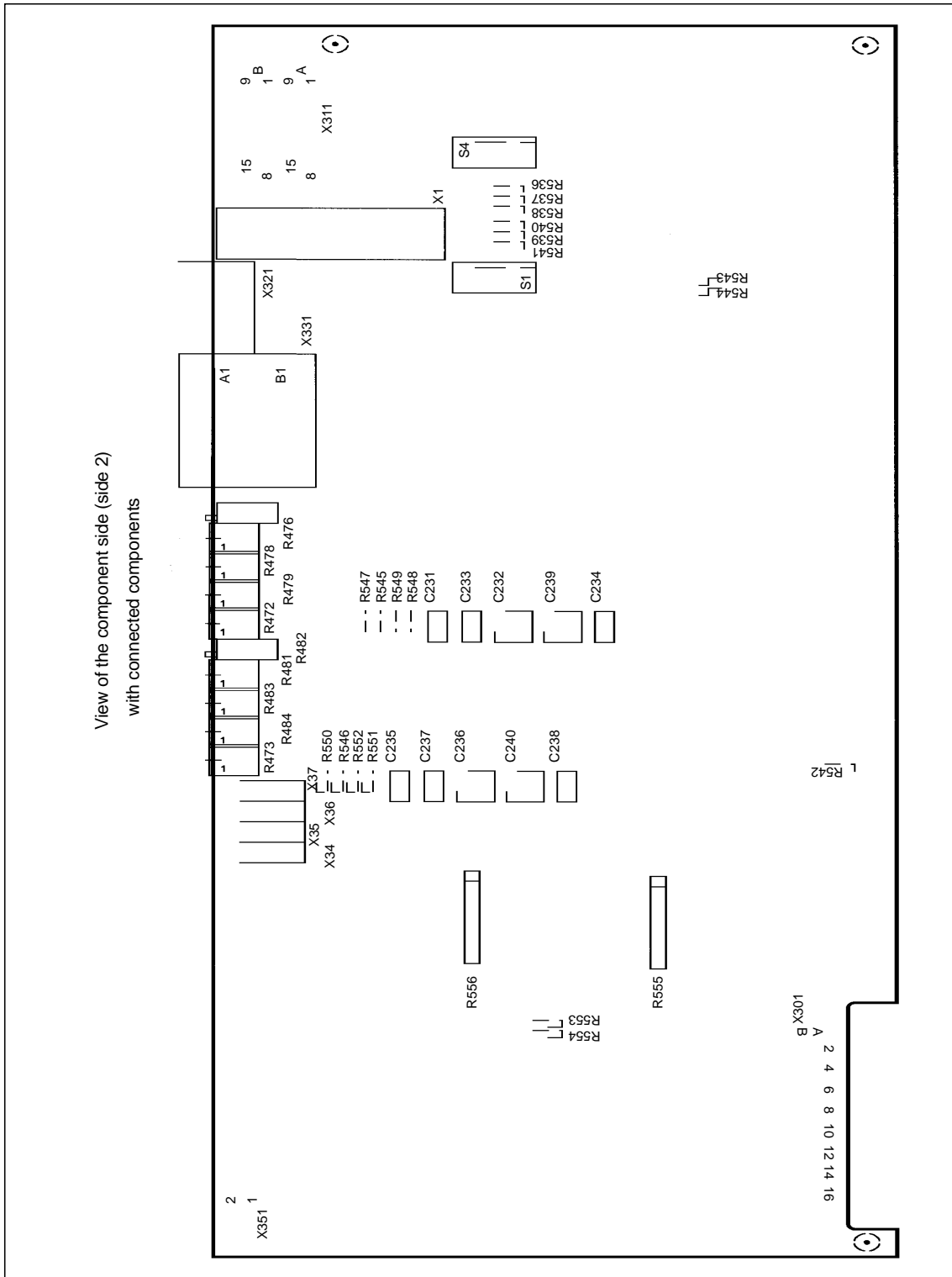

Fig. 9-2 Layout diagram, parameter board

9.4 Layout diagram, standard interface



VS

Fig. 9-3 Layout diagram, standard interface

9.5 Layout diagram, speed control loop (user-friendly interface)

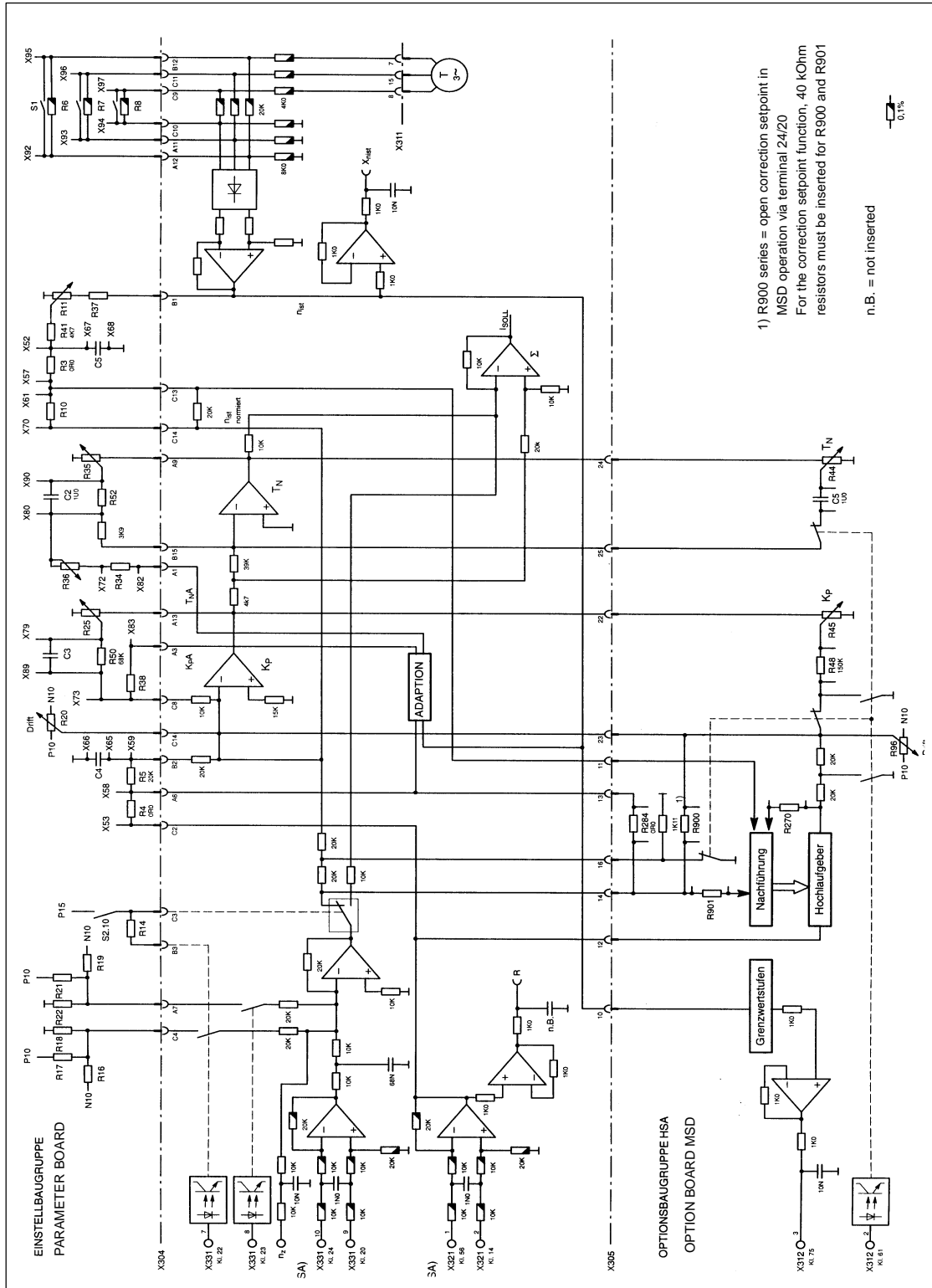

Fig. 9-4 Layout diagram, speed control loop

9.6 Motor encoder, assignment of X311/X313 (1st/2nd axis)

PIN assignment connecting cable motor feed control

Table 9-4 Pin assignment, connecting cable

Signal	Encoder connector	Feed control
RLG S	1	13
RLG T	2	5
RLG R	3	6
P15	4	4
Ground	5	2
Tach. M	6	14
Tach. T	7	7
Shield	8	1/9
PTC	9	11
PTC	10	12
Tach. R	11	8
Tach. S	12	15

For terminating connectors for axes which are not used – type Sub Min D 15-pin (socket) connect pin 13 to pin 2 and pin 11 to pin 12.



VS

Space for notes

Index**A**

Actual value normalization, VS/1-4
Adaptation tables, VS/1-5

C

C-axis operation, VS/5-39
Changeover parameter for C-axis operation, VS/5-39
Commissioning
 Commissioning stages, VS/1-3
 Short commissioning, VS/1-3
 Standard commissioning, VS/1-3
 with the MSD option, VS/5-35
Current controller gain, VS/1-5
Current controller settings, VS/1-4

D

Diagnostics, VS/8-47
Drift compensation, VS/2-23

E

Electronic weight equalization, VS/3-30, VS/3-32

F

Fault display, VS/8-48
Functions via fixed values, VS/5-38

G

Gain K_p with adaptation, VS/2-22

I

I-component limiting, VS/2-23
Integral action time with adaptation, VS/2-21

K

K_p gain without adaptation, VS/2-19

L

Layout diagram MSD option board, VS/9-53

Layout diagram, parameter board, VS/9-54
Layout diagram, speed control loop, VS/9-56
Layout diagram, standard interface, VS/9-55
Limit value stages, VS/5-37

M

Master/slave, VS/3-29
MSD option board, VS/9-53

N

Normalization of the M/P display, VS/5-37

O

Operating display, VS/8-47

P

Parameter board, VS/9-54
Pin assignment X311 and X313, VS/9-57
Proportional gain K_p with adaptation, VS/2-22
Proportional gain k_p without adaptation, VS/2-19

R

Ramp-up time, VS/5-35

S

Service and diagnostics, VS/8-47
Setting elements
 with standard interface, VS/3-25
 with user-friendly interface, VS/3-29
Settings via fixed values, VS/5-38
Speed control loop, VS/9-56
Standard commissioning, VS/1-3
Standard interface, VS/1-4, VS/9-55
Standard settings, VS/1-3
Supplementary setpoint, VS/3-29

T

Tachometer adaptation, VS/1-4
Tachometer calibration, VS/2-18
Test sockets and display elements
 standard interface, VS/8-49
 user-friendly interface, VS/8-47
Timer, VS/3-29
Torque limiting, VS/5-36
Travel to fixed endstop, VS/3-29
Troubleshooting, VS/8-50

Index

U

User-friendly interface, VS/1-4

W

Weight equalization, VS/3-30

Feed Modules, Resolver Control (VR)

1	Short Start-Up, Standard Settings	VR/1-3
1.1	Pole numbers	VR/1-3
1.2	Speed actual value normalization [RPM]	VR/1-4
1.3	Current controller settings	VR/1-5
2	Speed Controller Optimization	VR/2-11
2.1	Tachometer calibration	VR/2-12
2.2	Setting the proportional gain K_p	VR/2-13
2.3	Setting the integral action time T_N	VR/2-14
2.4	Drift compensation (offset)	VR/2-14
3	Start-Up, Supplementary Functions	VR/3-15
3.1	Position processing	VR/3-15
3.2	Current setpoint limiting	VR/3-15
3.3	Other functions	VR/3-16
3.4	Operating feed modules without a connected motor	VR/3-18
4	Setpoint Interfaces	VR/4-19
4.1	Overview	VR/4-19
4.2	External speed setpoint smoothing	VR/4-20
5	Free for Expansions	VR/5-21
6	Free for Expansions	VR/6-23
7	Powering-Up	VR/7-25
8	Service and Diagnostics	VR/8-27
9	Attachments	VR/9-29
9.1	Terminals	VR/9-29
9.2	Layout diagrams	VR/9-30
9.2.1	Layout diagram, resolver control	VR/9-30
9.2.2	Layout diagram, DIL switch	VR/9-32
9.3	Connector assignment	VR/9-33
9.3.1	X311/X312, encoder interface axis 1/axis 2	VR/9-33
9.3.2	X391/X392, angular encoder interface, axis 1/axis 2	VR/9-34

Start-up stages of the VSA modules, resolver control

Start-up is divided into various steps. After the standard settings have been made, an additional start-up stage can be made before the equipment can be powered-up.

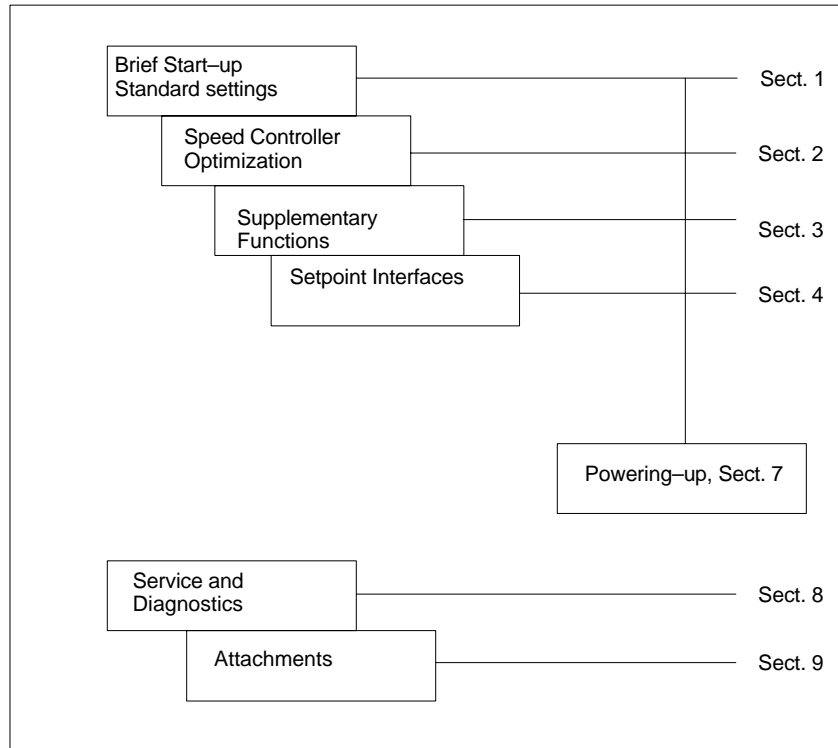

Short Start–Up, Standard Settings

1

The setting elements (switches) are provided on the board and must be set when installing the control board into the power module.

1.1 Pole numbers



Important

The pole pair numbers for the motor and resolver must be set before commissioning the system. Otherwise, the drive will not run.

Axis 1: DIL switch, S1 contacts 1–4

Axis 2: DIL switch, S2 contacts 1–4

Table 1-1 Pole numbers

	2p motor	2	4	6	8	2p resolver	2	4	6	8
Axis 1	S1.x ON	–	1	2	1+2	S1.x ON	–	3	4	3+4
Axis 2	S2.x ON	–	1	2	1+2	S2.x ON	–	3	4	3+4

The pole (pair) numbers of the motors are dependent on the shaft height.

Table 1-2 Pole numbers of 1FT6 motors

Shaft height	36	48	63	80	100	132
Order No. [MLFB]	1FT6031 1FT6034	1FT6041 1FT6044	1FT6061 1FT6062 1FT6064	1FT6081 1FT6082 1FT6084 1FT6086	1FT6102 1FT6105 1FT6108	1FT6132 1FT6134 1FT6136
Pole number 2p	4	4	6	8	8	6

Table 1-3 Pole numbers of 1FK6 motors

Shaft heights	36	48	63	80	100
Order No. [MLFB]	1FK6032	1FK6040 1FK6042	1FK6060 1FK6063	1FK6080 1FK6083	1FK6100 1FK6101 1FK6103
Pole number 2p	6	6	6	6	8

**The pole (pair) number of the standard resolver is 2p=2.
The pole pair number of the resolver is specified on the motor rating plate.**

1.2 Speed actual value normalization [RPM]

These normalizations are valid for standard resolver pole number $2p=2$.

We recommend that the correct normalization is set up to the rated motor speed. For motors with rated speeds of 4500 RPM, we recommend that that normalization is set, which is the closest to the required system-rated speed.

For motors with rated speed 1500 RPM, the normalization should be set for 2000 RPM.

Axis 1: DIL switch S4 contacts 1–4

Axis 2: DIL switch S4 contacts 5–8

Table 1-4 Speed normalization

	n_{rated}	2000	3000	3000	6000
Axis 1	S4.x ON	–	1+3	2+4	1+2+3+4
Axis 2	S4.x ON	–	5+7	6+8	5+6+7+8

alternatively possible

Refer to Section 2.1 for more detailed information about the speed ranges which can be set.

1.3 Current controller settings

DIL switch Axis 1: DIL switch S3
 Axis 2: DIL switch S6

Current actual value normalization

$$\text{Current limit} = \frac{I_{\max} \text{ (selected value)}}{I_{\text{limit}} \text{ (power module)}} \quad [\%]$$

I_{\max} must be reduced as a minimum to the peak current permitted for the motor.

Table 1-5 Current actual value normalization [%]

	$I_{\max}/I_{\text{LIMIT}} [\%]$	100	70
Axis 1	S3.x ON	–	1+2
Axis 2	S6.x ON	–	1+2

VR

Current controller gain

$$K_p (l) < \frac{I_{\max} \cdot L_A}{25} = \frac{I_{\text{limit}} \cdot \text{current limit} \cdot L_A}{25}$$

I_{\max} = selected maximum current (RMS value) of the axis in A
 L_A = rotating inductance of the motor in mH (RMS value) (refer to the Planning Guide, AC Motors for Feed and Main Spindle Drives). Round-off calculated values to a selectable value!

Table 1-6 Current controller gain $K_p (l)$

	Kp(l)	1	2	3	4	5	6	7.5	8.5	9.5	10.5	11.5	12.5	13.5	14.5	16
Axis 1	S3.x ON	–	3+7	4+8	3+4 + 7+8	5+9	3+5 + 7+9	4+5 + 8+9	3+4+ 5+7+ 8+9	3+6 + 7+10	4+6 + 8+10	3+4+ 6+7+ 8+10	5+6 + 9+10	3+5+ 6+7+ 9+10	4+5+ 6+8+ 9+10	3+4+ 5+6+ 7+8+ 9+10
Axis 2	S6.x ON	–	3+7	4+8	3+4 + 7+8	5+9	3+5 + 7+9	4+5 + 8+9	3+4+ 5+7+ 8+9	3+6 + 7+10	4+6 + 8+10	3+4+ 6+7+ 8+10	5+6 + 9+10	3+5+ 6+7+ 9+10	4+5+ 6+8+ 9+10	3+4+ 5+6+ 7+8+ 9+10

Adaptation tables

Definition: o = Contact in the basic OFFsetting
 x = Contact in the ON setting

1.3 Current controller settings

Table 1-7 Adaptation table for 6SN112□-1A□00-0HA1 power modules, 3/6 A resolver control

Servomotor				Curr. act. value norm. Axis 1: S3 Axis 2: S6		Current controller gain Kp(I) Axis 1: S3 Axis 2: S6				
1FT	M _o [Nm] 60K	I _o [A] 60K	n _{rated} [RPM]	Contact 1+2	I _{max} [%]	Contacts				Kp(I)
						3+7	4+8	5+9	6+10	
6031-4AK	0.83	1.2	6000	x	70	o	o	x	o	5.0
6034-4AK	1.65	2.15	6000	o	100	x	x	o	o	4.0
6041-4AF	2.15	1.55	3000	o	100	o	x	o	x	10.5
6041-4AK	2.15	2.55	6000	o	100	x	x	o	o	4.0
6044-4AF	4.15	2.50	3000	o	100	o	x	x	o	7.5
6061-6AC	3.30	1.60	2000	o	100	x	x	x	x	16.0
6061-6AF	3.30	2.25	3000	o	100	x	x	x	o	8.5
6062-6AC	5.00	2.30	2000	o	100	x	x	o	x	11.5

1FK	M _o [Nm] 60K	I _o [A] 60K	n _{rated} [RPM]	Contact 1+2	I _{max} [%]	Contacts				Kp(I)
						3+7	4+8	5+9	6+10	
6032-6AK	0.90	1.40	6000	o	100	x	x	o	o	4.0
6040-6AF	1.30	1.10	3000	x	70	x	o	x	o	6.0
6040-6AK	1.3	2.2	6000	0	100	x	0	0	0	2.0
6042-6AF	2.65	2.20	3000	o	100	x	x	o	o	4.0

Definition: o = Contact in the basic OFF setting
x = Contact in the ON setting

Table 1-8 Adaptation table for 6SN112□-1A□00-0AA1 power modules, 5/10 A resolver control

Servomotor				Curr. act. value norm. Axis 1: S3 Axis 2: S6		Current controller gain Kp(I) Axis 1: S3 Axis 2: S6				
1FT	M _o [Nm] 60K	I _o [A] 60K	n _{rated} [RPM]	Contact 1+2	I _{max} [%]	Contacts				Kp(I)
						3+7	4+8	5+9	6+10	
6034-4AK	1.65	2.15	6000	x	70	o	o	x	o	5.0
6041-4AF	2.15	1.55	3000	x	70	o	x	x	x	14.5
6041-4AK	2.15	2.55	6000	o	100	o	x	x	o	7.5
6044-4AF	4.15	2.50	3000	o	100	x	o	x	x	13.5
6044-4AK	4.15	4.85	6000	o	100	x	x	o	o	4.0
6061-6AF	3.30	2.25	3000	o	100	x	x	x	x	16.0
6061-6AH	3.30	3.35	4500	o	100	o	x	x	o	7.5
6061-6AK	3.30	4.10	6000	o	100	x	x	o	o	4.0
6062-6AC	5.00	2.30	2000	x	70	x	x	x	x	16.0
6062-6AF	5.00	3.40	3000	o	100	o	x	o	x	10.5
6062-6AH	5.00	4.80	4500	o	100	o	o	x	o	5.0
6062-6AK	5.00	6.40	6000	o	100	o	x	o	o	3.0
6064-6AC	7.90	3.50	2000	o	100	o	x	x	x	14.5
6064-6AF	7.90	5.00	3000	o	100	o	x	x	o	7.5
6081-8AC	6.60	3.40	2000	o	100	x	o	x	x	13.5

1FK	M _o [Nm] 60K	I _o [A] 60K	n _{rated} [RPM]	Contact 1+2	I _{max} [%]	Contacts				Kp(I)
						3+7	4+8	5+9	6+10	
6040-6AK	1.30	2.20	6000	x	70	o	x	o	o	3.0
6042-6AF	2.65	2.20	3000	o	100	o	x	x	o	7.5
6060-6AF	5.00	3.60	3000	o	100	o	x	x	o	7.5
6080-6AF	6.60	4.50	3000	o	100	o	x	x	o	7.5

Definition: o = Contact in the basic OFF setting
 x = Contact in the ON setting

1.3 Current controller settings

Table 1-9 Adaptation table for 6SN112□-1A□00-0BA1 power modules, 9/18 A resolver control

Servomotor				Curr. act. value norm. Axis 1: S3 Axis 2: S6		Current controller gain Kp(I) Axis 1: S3 Axis 2: S6				
1FT	M _o [Nm] 60K	I _o [A] 60K	n _{rated} [RPM]	Contact 1+2	I _{max} [%]	Contacts				Kp(I)
						3+7	4+8	5+9	6+10	
6044-4AK	4.15	4.85	6000	o	100	x	o	x	o	6.0
6061-6AF	3.30	2.25	3000	x	70	x	x	x	x	16.0
6061-6AH	3.30	3.25	4500	o	100	x	x	o	x	11.5
6061-6AK	3.30	4.10	6000	o	100	o	x	x	o	7.5
6062-6AF	5.00	3.40	3000	o	100	x	x	x	x	16.0
6062-6AH	5.00	4.80	4500	o	100	x	x	x	o	8.5
6062-6AK	5.00	6.40	6000	o	100	o	o	x	o	5.0
6064-6AC	7.90	3.50	2000	x	70	x	x	x	x	16.0
6064-6AF	7.90	5.00	3000	o	100	o	o	x	x	12.5
6064-6AH	7.90	7.60	4500	o	100	o	o	x	o	5.0
6064-6AK	7.90	9.90	6000	o	100	o	x	o	o	3.0
6081-8AC	6.60	3.40	2000	x	70	x	x	x	x	16.0
6081-8AF	6.60	4.90	3000	o	100	o	x	o	x	10.5
6081-8AH	6.60	7.40	4500	o	100	o	o	x	o	5.0
6081-8AK	6.60	9.40	6000	o	100	o	x	o	o	3.0
6082-8AC	10.40	5.50	2000	o	100	o	x	x	x	14.5
6082-8AF	10.40	8.20	3000	o	100	x	o	x	o	6.0
6084-8AC	16.20	7.55	2000	o	100	o	x	o	x	10.5
6084-8AK	16.20	20.50	6000	o	100	o	o	o	o	1.0
6102-8AB	22.40	7.40	1500	o	100	o	o	x	x	12.5

1FK	M _o [Nm] 60K	I _o [A] 60K	n _{rated} [RPM]	Contact 1+2	I _{max} [%]	Contacts				Kp(I)
						3+7	4+8	5+9	6+10	
6060-6AF	5.00	3.60	3000	x	70	x	o	o	x	9.5
6063-6AF	9.10	6.60	3000	o	100	x	o	x	o	6.0
6080-6AF	6.60	4.50	3000	o	100	o	o	x	x	12.5
6083-6AF	13.30	8.50	3000	o	100	o	x	x	o	7.5
6100-8AF	15.00	10.20	3000	o	100	o	x	o	o	3.0

Definition: o = Contact in the basic OFF setting
x = Contact in the ON setting

Table 1-10 Adaptation table for 6SN112□-1A□00-0CA1 power modules, 18/36 A resolver control

Servomotor				Curr. act. value norm. Axis 1: S3 Axis 2: S6		Current controller gain Kp(I) Axis 1: S3 Axis 2: S6				Kp(I)
1FT	M ₀ [Nm] 60K	I ₀ [A] 60K	n _{rated} [RPM]	Contact 1+2	I _{max} [%]	Contacts				
						3+7	4+8	5+9	6+10	
6062-6AH	5.00	4.80	4500	x	70	x	x	o	x	11.5
6062-6AK	5.00	6.40	6000	o	100	x	o	o	x	9.5
6064-6AF	7.90	5.00	3000	x	70	x	x	x	x	16.0
6064-6AH	7.90	7.60	4500	o	100	o	x	o	x	10.5
6064-6AK	7.90	9.90	6000	o	100	x	o	x	o	6.0
6081-8AH	6.60	7.40	4500	o	100	o	x	o	x	10.5
6081-8AK	6.60	9.40	6000	o	100	x	o	x	o	6.0
6082-8AF	10.40	8.20	3000	o	100	x	o	x	x	13.5
6082-8AH	10.40	12.20	4500	o	100	x	o	x	o	6.0
6082-8AK	10.40	14.65	6000	o	100	x	x	o	o	4.0
6084-8AC	16.20	7.55	2000	x	70	o	x	x	x	14.5
6084-8AF	16.20	11.30	3000	o	100	x	o	o	x	9.5
6084-8AH	16.20	16.70	4500	o	100	x	x	o	o	4.0
6084-8AK	16.20	20.50	6000	o	100	o	x	o	o	3.0
6086-8AC	22.40	10.00	2000	o	100	x	x	x	x	16.0
6086-8AF	22.40	14.40	3000	o	100	x	x	x	o	8.5
6086-8AH	22.40	20.40	4500	o	100	x	x	o	o	4.0
6102-8AB	22.40	7.40	1500	x	70	x	x	x	x	16.0
6102-8AC	22.40	10.20	2000	o	100	x	o	x	x	13.5
6102-8AF	22.40	14.20	3000	o	100	o	x	x	o	7.5
6102-8AH	22.40	20.60	4500	o	100	o	x	o	o	3.0
6105-8AB	41.50	13.80	1500	o	100	o	x	x	x	14.5
6105-8AC	41.50	18.40	2000	o	100	x	x	x	o	8.5
6084-8SF	22.00	16.30	3000	o	100	x	x	x	o	8.5

1FK	M ₀ [Nm] 60K	I ₀ [A] 60K	n _{rated} [RPM]	Contact 1+2	I _{max} [%]	Contacts				Kp(I)
						3+7	4+8	5+9	6+10	
6063-6AF	9.10	6.60	3000	x	70	o	x	x	o	7.5
6083-6AF	13.30	8.50	3000	o	100	x	o	x	x	13.5
6100-8AF	15.00	10.20	3000	o	100	x	o	x	o	6.0
6101-8AF	22.40	14.40	3000	o	100	o	o	x	o	5.0
6103-8AF	30.00	19.00	3000	o	100	o	x	o	o	3.0

Definition: o = Contact in the basic OFF setting
x = Contact in the ON setting

1.3 Current controller settings

Table 1-11 Adaptation table for 6SN112□-1AA00-0DA1 power modules, 28/56 A resolver control

Servomotor				Curr. act. value norm. Axis 1: S3 Axis 2: S6		Current controller gain Kp(I) Axis 1: S3 Axis 2: S6				
1FT	M ₀ [Nm] 60K	I ₀ [A] 60K	n _{rated} [RPM]	Contact 1+2	I _{max} [%]	Contacts				Kp(I)
						3+7	4+8	5+9	6+10	
6062-6AK	5.00	6.40	6000	x	70	x	x	o	x	11.5
6064-6AH	7.90	7.60	4500	X	70	x	x	o	x	11.5
6064-6AK	7.90	9.90	6000	o	100	x	o	o	x	9.5
6081-8AK	6.60	9.40	6000	x	70	x	o	x	o	6.0
6082-8AF	10.40	8.20	3000	x	70	o	x	x	x	14.5
6082-8AH	10.40	12.20	4500	o	100	x	x	o	x	11.5
6082-8AK	10.40	14.65	6000	o	100	x	o	x	o	6.0
6084-8AF	16.20	11.30	3000	o	100	x	x	x	x	16.0
6084-8AH	16.20	16.70	4500	o	100	x	o	x	o	6.0
6084-8AK	16.20	20.50	6000	o	100	o	o	x	o	5.0
6086-8AC	22.40	10.00	2000	x	70	x	x	x	x	16.0
6086-8AF	22.40	14.40	3000	o	100	x	o	o	x	9.5
6086-8AH	22.40	20.40	4500	o	100	x	o	x	o	6.0
6102-8AC	22.40	10.20	2000	x	70	x	x	x	x	16.0
6102-8AF	22.40	14.20	3000	o	100	x	x	o	x	11.5
6102-8AH	22.40	20.60	4500	o	100	o	o	x	o	5.0
6105-8AB	41.50	13.80	1500	x	70	x	x	x	x	16.0
6105-8AC	41.50	18.40	2000	o	100	x	o	x	x	13.5
6105-8AF	41.50	27.70	3000	o	100	x	o	x	o	6.0
6108-8AB	58.00	18.50	1500	o	100	x	x	x	x	16.0
6108-8AC	58.00	24.00	2000	o	100	x	o	o	x	9.5
6132-6AB	62.00	18.50	1500	x	70	x	x	x	x	16.0
6132-6AC	62.00	25.00	2000	o	100	o	o	x	x	12.5
6132-6AF	62.00	37.00	3000	o	100	x	o	x	o	6.0
6134-6AB	79.00	24.00	1500	o	100	x	x	x	x	16.0
6134-6AC	79.00	31.50	2000	o	100	o	x	x	x	14.5
6136-6AB	95.00	28.00	1500	o	100	o	x	x	x	14.5
6084-8SF	22.00	16.30	3000	o	100	o	x	x	x	14.5
6084-8SH	22.00	22.90	4500	o	100	x	o	x	o	6.0
6084-8SK	22.00	31.00	6000	o	100	x	x	o	o	4.0
6086-8SF	29.50	22.30	3000	o	100	x	o	o	x	9.5
6105-8SC	50.00	25.00	2000	o	100	x	x	o	x	11.5

1FK	M ₀ [Nm] 60K	I ₀ [A] 60K	n _{rated} [RPM]	Contact 1+2	I _{max} [%]	Contacts				Kp(I)
						3+7	4+8	5+9	6+10	
6083-6AF	13.30	8.50	3000	x	70	o	x	x	x	14.5
6100-8AF	15.00	10.20	3000	x	70	o	x	x	o	7.5
6101-8AF	22.40	14.40	3000	o	100	o	x	x	o	7.5
6103-8AF	30.00	19.00	3000	o	100	o	o	x	o	5.0

Definition: o = Contact in the basic OFF setting
x = Contact in the ON setting



Speed Controller Optimization

2

The additional smoothing functions in the speed controller loop (damping mechanical resonance points) are described in section 3. Proceed as follows when optimizing the speed controller :

1. Tachometer calibration
2. Gain K_p
3. Integral action time T_N
4. Drift compensation (offset)

To optimize the speed controller, the equipment must be powered-up. Therefore observe Section 7 "Powering-up".

VR

The specification of the potentiometer scale (in the setting table) is defined as follows:

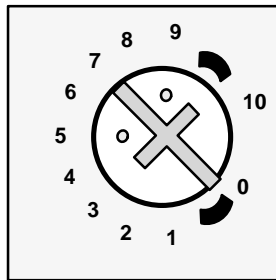

The settings shown in the diagram corresponds to 7 scale units.

2.1 Tachometer calibration

The actual drive speed for ± 10 V speed setpoint can be varied in the following range by the rated speed, set under Section 1.2:

Potentiometer	Setting range
	$0.6 n_{\text{rated}} \leq n_{\text{act N}} \leq 1,8 n_{\text{rated}}$

The following setting ranges are obtained for a ± 10 V speed setpoint according to the rated speeds, set in Section 1.2:

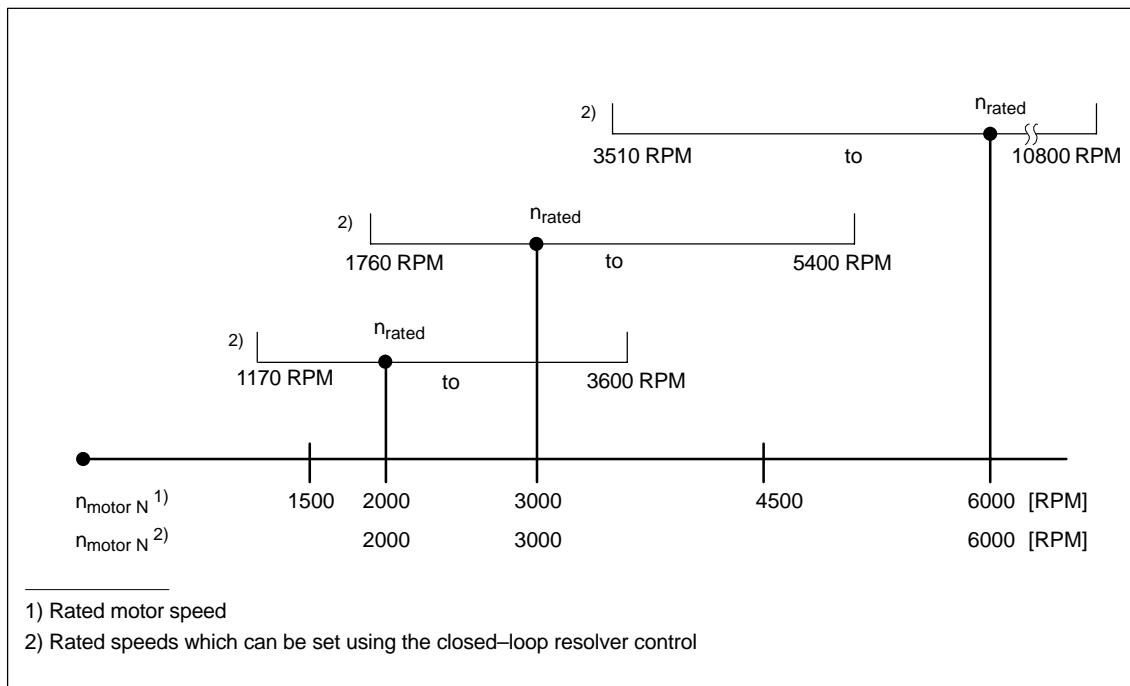

Fig. 2-1 Setting ranges for a ± 10 V speed setpoint

When the speed setpoint is reduced, the setting range is also appropriately reduced. We recommend that the motors with a rated speed of 6000 RPM are operated using a ± 8 V speed setpoint, in order to limit the selectable maximum speed.



Warning

Only the specified setting ranges are permissible! The setting range and the maximum speed setpoint must be defined, so that the maximum permissible speed of the connected motor is never exceeded. The maximum permissible motor speeds are specified in the Motor Planning Guide.

2.2 Setting the proportional gain Kp

The proportional gain Kp of the speed controller can be set using potentiometer Kp. The gain, set using the Kp potentiometer, is only insignificantly influenced by the setting of the T_N potentiometer.

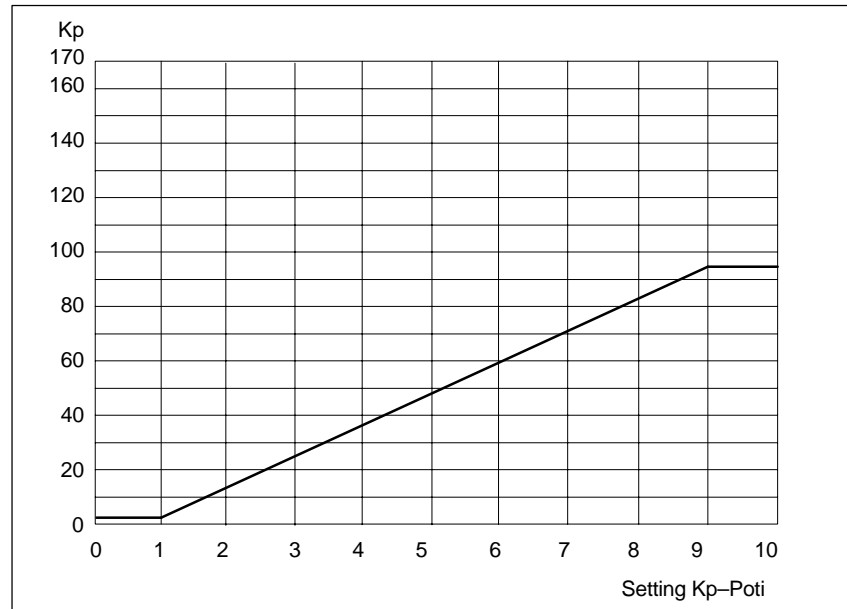

Fig. 2-2 Proportional gain Kp as a function of the Kp potentiometer

If the electronic weight equalization is active (refer to Section 3.3), then this proportional gain is increased by the following factor:

$$\frac{\text{Kp (with weight equalization)}}{\text{Kp}} = 1 + \frac{I_{\text{weight equalization}}}{I_{\text{Max}}}$$

2.3 Setting the integral action time T_N

The speed controller integral action time is set using potentiometer T_N .

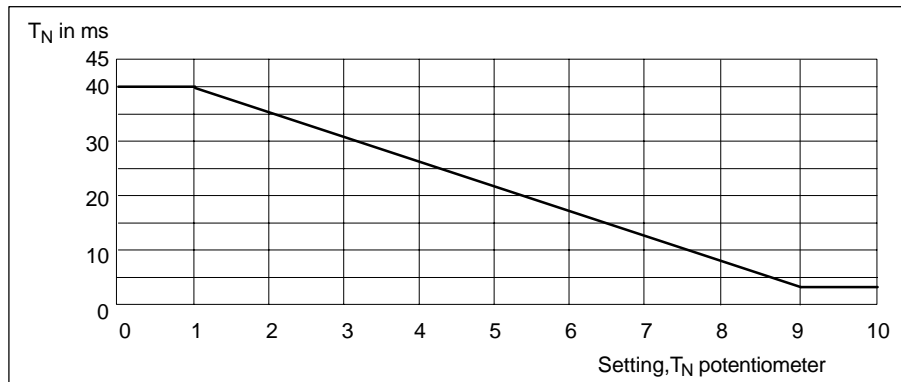

Fig. 2-3 Integral action time T_N as a function of the T_N potentiometer

2.4 Drift compensation (offset)

The drift is compensated for $n_{set} = 0$ using a potentiometer

Potentiometer drift	Control range ± 45 mV
---------------------	---------------------------



3

Start-Up, Supplementary Functions

3.1 Position processing

The angular encoder interface is not influenced by the controller inhibits (terminal 63, terminal 64, terminal 65, terminal 663) and the central RESET (terminal R). For encoder errors and for a power-on reset, the output signals are switched to a high ohmic state.

	Switch for axis 1	Switch for axis 2	Effect
Pole (pair) number, motor ¹⁾ Pole (pair) number, resolver ^{1) 4)}	S1.x S1.x	S2.x S2.x	2p=2, 4, 6, 8 corr. to p=1, 2, 3, 4 2p=2, 4, 6, 8 corr. to p=1, 2, 3, 4
Phase sequence of tracks A, B (angular encoder interface)	S1.6=OFF S1.6=ON	S2.6=OFF S2.6=ON	A before B for clockwise rot. ²⁾ B before A for clockwise rot. ²⁾
Pulse number, angular encoder interface	S1.7=OFF S1.7=ON	S2.7=OFF S2.7=ON	512 pulses/revolution 1024 pulses/revolution
Zero offset ³⁾	S1.8+S11.x=OFF S1.8=ON S11.1=ON S11.2=ON S11.3=ON S11.4=ON S11.5=ON	S2.8+S11.x=OFF S2.8=ON S11.6=ON S11.7=ON S11.8=ON S11.9=ON S11.10=ON	Shift by 0° mechanical Shift by 5.625° mechanical Shift by 11.25° mechanical Shift by 22.5° mechanical Shift by 45° mechanical Shift by 90° mechanical Shift by 180° mechanical

3.2 Current setpoint limiting

Function	Switch for axis 1	Switch for axis 2	Effect
Current setpoint limiting by 1 Selecting terminal 96 or for SETTING-UP operation Caution! The same limit is effective for both functions.	S12.x=OFF S12.4=ON S12.3=ON S12.3+4=ON S12.2=ON S12.2+3=ON S12.1=ON	S12.x=OFF S12.8=ON S12.7=ON S12.7+8=ON S12.6=ON S12.6+7=ON S12.5=ON	Limiting to 100% Limiting to 75% Limiting to 55% Limiting to 45% Limiting to 25% Limiting to 20% Limiting to 5%

¹⁾ The pole pair numbers must be set before commissioning (refer to Section 1)

²⁾ When viewing the drive shaft end

³⁾ The resulting zero offset is the sum of all of the selected offsets

⁴⁾ The number zero marks per mechanical revolution is the same as pole pair number P of the resolver

3.3 Other functions

3.3 Other functions

Function	Switch for axis 1	Switch for axis 2	Effect
Integrator inhibit, speed controller Integrator inhibit, I controller ¹⁾ Fault message Master/slave Timer ²⁾	S5.1=OFF/ON S5.2=OFF/ON S5.5=OFF/ON S5.7=OFF/ON	S5.3=OFF/ON S5.4=OFF/ON S5.5=OFF/ON S5.6=OFF/ON S5.8=OFF/ON	Enable/inhibit Enable/inhibit Changeover, fault/ready signal 2nd axis as slave ³⁾ 1 s / 300 ms
Function ⁴⁾	Component for axis 1	Component for axis 2	Condition when shipped
Smoothing functions: Speed setpoint Speed actual value Speed controller T_N limiting in the speed controller Weight equalization pos. I_{SET} Weight equalization neg. I_{SET}	C135 ⁵⁾ C143 ⁵⁾ C134 ⁵⁾ R448 ⁶⁾ R349 ⁶⁾ R348 ⁶⁾	C148 ⁵⁾ C149 ⁵⁾ C147 ⁵⁾ R454 ⁶⁾ R356 ⁶⁾ R355 ⁶⁾	33 nF corresponds to 220 μ s — 1 nF corresponds to 160 μ s — — —

Calculating the smoothing time constants

Speed setpoint $t_{set} = C135(C148) \cdot 6.67 \text{ k}\Omega$

Speed actual value $t_{act} = C143(C149) \cdot 6.67 \text{ k}\Omega$

Speed actual value $t_{nreg} = C134(C147) \cdot 160 \text{ k}\Omega$

The following components are mounted on the component side ("Page 2"):
C135, C143, C134, R348, R349, R454

The following components are provided on the solder side ("Page 1"):
C148, C149, C147, R355, R356, R448

Dimensioning ext. speed setpoint smoothing

Refer to Section 4.2.

Parameterizing the electronic weight equalization

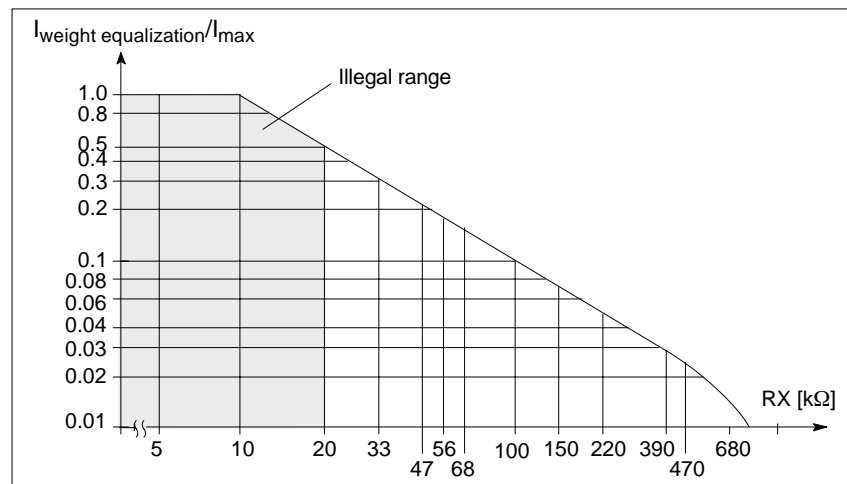

Fig. 3-1 Supplementary current setpoint for electronic weight equalization

VR

Master–slave operation

Closed–loop current controlled operation must always be selected for the slave axis using terminal 22. On the 2–axis control, master and slave can only be operated with mutually opposite directions of rotation.

When using a 1–axis control as master, the directions of rotation of the master and slave can either be opposing or the same. This is selected by connecting the current setpoint output (terminal 258, terminal 15) to the current setpoint differential input (terminal 24, terminal 20).

- 1) This function is only effective in closed–loop current controlled operation; in the closed–loop speed controlled operation, the current controller integrator is always enabled
- 2) For terminal 65 and “speed controller at its endstop” monitoring
- 3) Caution: The master and slave have **opposing directions of rotation!**
- 4) Adaptation only for difficult operating conditions.
Adaptation is realized, when required by soldering in SMD components
- 5) SMD component, packaging type 0805
- 6) SMD component, packaging type 0204/mini melf; equivalent, can be replaced by packaging type 0805

3.4 Operating feed modules without a connected motor

3.4 Operating feed modules without a connected motor

Two-axis modules can be operated as single-axis module using the subsequently described measures.

In order to permit correct operation of the drive group, the monitoring functions "motor temperature" and "encoder fault" must be suppressed at the axis which is not connected.

In this case, the following signals on the encoder interface (X311/X312) of the axis which is not connected, must be connected together using jumpers.

Measure	Signal	Pin	Connect with	Pin	Signal
1	TEMP_PLUS	13	————	25	TEMP_MINUS
2	SIN_PLUS	3	————	9	RES_POS
3	SIN_MINUS	4	————	11	RES_NEG



Warning

If measure one is not implemented, the group signal "I2t/motor temperature" of the I/R or UE module will be set to fault (overtemperature).

If measure 2.3 is not implemented, the ready relay of the I/R and UE module will signal "fault/not ready".



4

Setpoint Interfaces

4.1 Overview

Definitions:

- Optimum, taking into account the setpoint input properties
- Possible
- Not permitted, also, in some cases, not possible

VR

Table 4-1 Main setpoint – supplementary setpoints

Mode	Setpoint	Terminal 56/14	Terminal 24/20	Terminal 258/15 ¹⁾
Cl.-loop speed controlled	Main setpoint	X		
	Suppl. setpoint		X	
Cl.-loop current controlled	Main setpoint		X	
	Suppl. setpoint			
Slave, cl.-loop curr. contr. current setpoint input	Main setpoint		X	
	Suppl. setpoint			
Master, cl.-loop speed contr. current setpoint output	Main setpoint			X
	Suppl. setpoint			

1) only for a 1-axis version,
for 2-axis version, is realized using an internal module connection

4.2 External speed setpoint smoothing

Locations C135 and C148 are provided on the module for the internal speed setpoint smoothing (refer to Section 3.3). The locations are intended for SMD capacitors. Time constants of approx. 1 ms can be achieved. Higher time constants must be realized by connecting suitable components at the speed setpoint input outside the module.

We recommend the following circuit configuration:

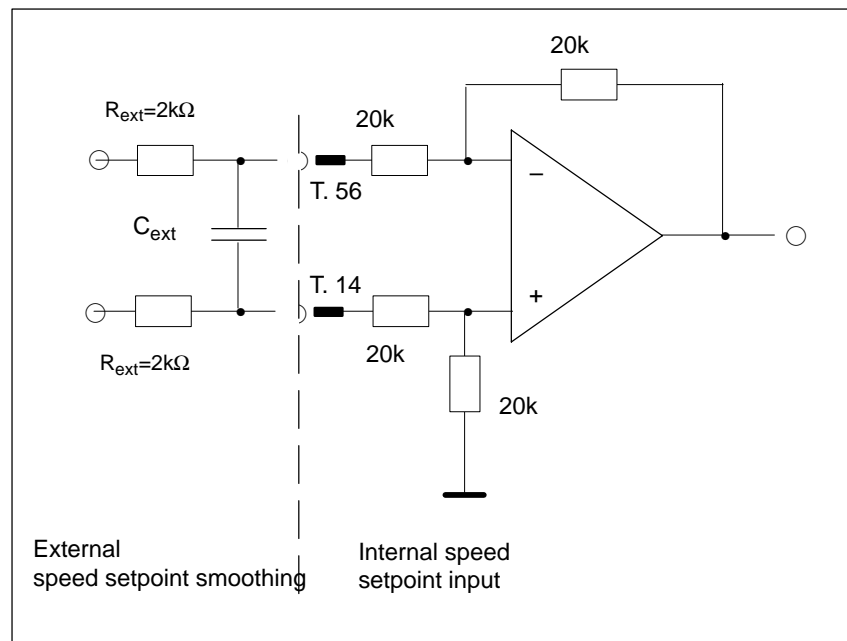

Fig. 4-1 External setpoint smoothing

The following is valid for the smoothing time constant of the speed setpoint:

$$t_{\text{set,total}} = t_{\text{set}} + t_{\text{set,external}}$$

$$t_{\text{set}} = \text{internal speed setpoint smoothing (refer to Section 3.3)}$$

$$t_{\text{set,external}} = C_{\text{ext}} \cdot 2 \cdot R_{\text{ext}} = C_{\text{ext}} \cdot 4 \text{ k}\Omega$$



Free for Expansions

5



VR

Free for Expansions

6



VR

7

Powering-Up

VR

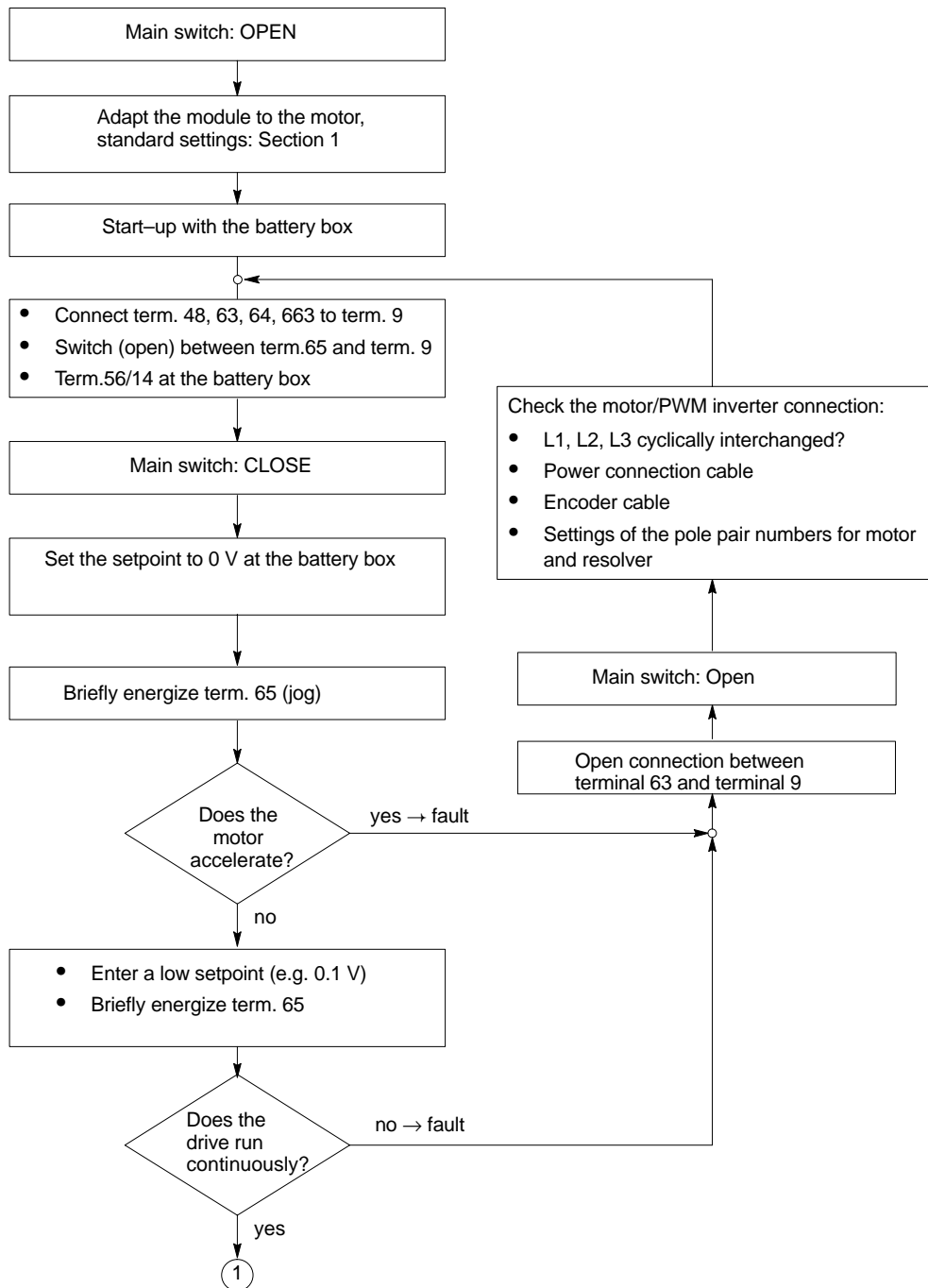

7 Powering-Up

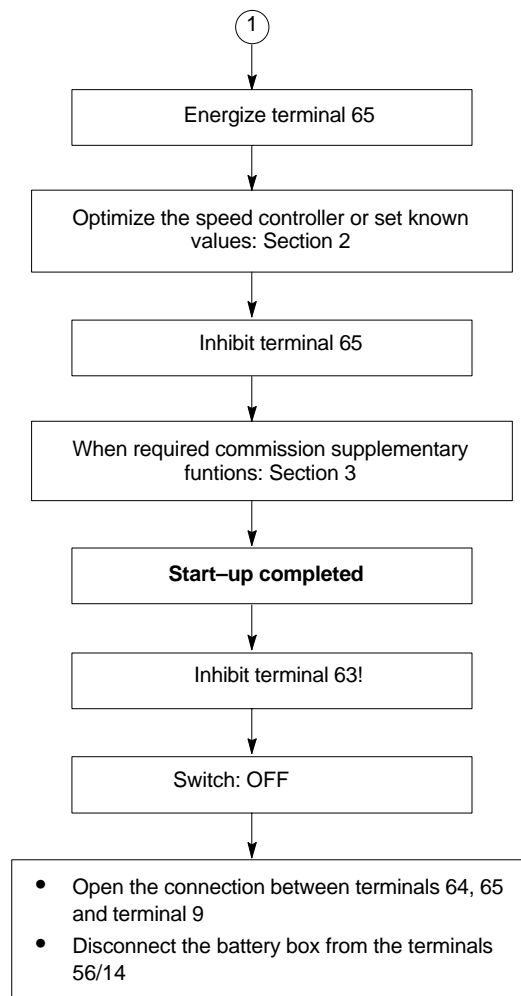

8

Service and Diagnostics

Test sockets

Terminal 16 = I_{act} and terminal 75 = n_{act} are available for measurements.

Normalization: Term.16: 10 V corresponds to I_{max}
 Term.75: 10 V corresponds to n_{rated} (refer to Section 2.1)

LED display

There is an LED on the front panel for fault diagnostics.
 Depending on the mode selected, either ready or fault is displayed.

Table 8-1 LED display

	LED dark	LED bright
Effect in the "ready" mode	Both axes of a 2-axis module are enabled.	A minimum of one axis is inhibited via the terminal or due to a fault message.
Effect in the "fault" mode	None of the two axes of a two-axis module is inhibited due to a fault message.	A minimum of one axis is inhibited due to a fault message.

Table 8-2 Causes of fault messages

Fault	Effect
Speed controller at its endstop	Saved ¹⁾
Encoder fault	Saved ¹⁾
Heat sink overtemperature	Pre-alarm at the NE module, saved after 4 s ¹⁾
Motor overtemperature	Pre-alarm at the NE module, not saved

1) saved=pulse inhibit

8 Service and Diagnostics

X391/X392

To support diagnostics, the following signals are available at the connector of the angular encoder interface.²⁾

Signal level: HCMOS / 5V

Table 8-3 Signals for fault analysis

Signal	Name	Pin	Status L=Low	Status H=High
READY	Hardware RESET	1	Power supply o.k.	Power supply voltage not o.k.: –run–up after power–on –P5 defective
ER_IL	I ² t monitoring	9	No fault	Fault: Heatsink temperature too high
ER_TNR	Speed controller end stop	10	No fault	Fault: Speed controller is already at its limit since 1s/300ms
EN_WSG	Enable angular encoder interface signals	11	Angular encoder interface inhibited Signals A, B, R high ohmic state –hardware RESET active –encoder fault	Angular encoder interface enabled Signals A, B, R valid



Warning

- 2) Internal module signals for fault analysis!
Not intended for use in external modules!
-



9

Attachments

9.1 Terminals

Table 9-1 Terminals

Ter. No.	Designation 2)	Function	Type 1)	Typ. voltage/limit value	Max. cross-section which can be connected
56	X321/322	} Speed setpoint	I	0V...±10V	1.5 mm ²
14	X321/322		I		
24	X321/322	} Speed/current setpoint	I	0V...±10V	1.5 mm ²
20	X321/322		I		
75	X321/322	Speed actual value	O	0V...±10V	1.5 mm ²
15	X321/322	Reference potential	O	0V	1.5 mm ²
16	X321/322	Active current actual value	O	0V...±10V	1.5 mm ²
96	X321/322	Power-on I _{set} limiting	I	+13V...30V	1.5 mm ²
9	X321/322	Enable potential	O	+24V	1.5 mm ²
22	X321/322	Changeover, speed/curr. control	I	+13V...30V	1.5 mm ²
9	X331	Enable potential	O	24V	1.5 mm ²
663	X331	Pulse enable	I	+21V...30V	1.5 mm ²
AS1	X331	} Relay, start inhibit	NC	max. 250V _{AC} /1A	1.5 mm ²
AS2	X331		NC		
9	X332	Enable potential	O	30V _{DC} /1A	1.5 mm ²
65.1	X332	Controller enable, axis 1	I	+13V...30V	1.5 mm ²
9	X332	Enable potential 3)	O	24V	1.5 mm ²
65.2	X332	Controller enable, axis 2 3)	I	+13V...30V	1.5 mm ²

For the 1-axis version, the following assignment is obtained for X332:

Table 9-2 Terminals

Ter. No.	Designation 2)	Function	Type 1)	Typ. voltage/limit value	Max. cross-section which can be connected
9	X332	Enable potential	O	+24V	1.5 mm ²
65.1	X332	Controller enable	I	+13V...30V	1.5 mm ²
15	X332	Reference potential	O	0V	1.5 mm ²
258	X332	Current setpoint	O	0V...±10V	1.5 mm ²

1) I = Input, O = Output, NC = NC contact, NO = NO contact (for signal: closed= high, open= low)

2) X321=1st axis, X322=2nd axis

3) only for 2-axis version

9.2 Layout diagrams

9.2.1 Layout diagram, resolver control

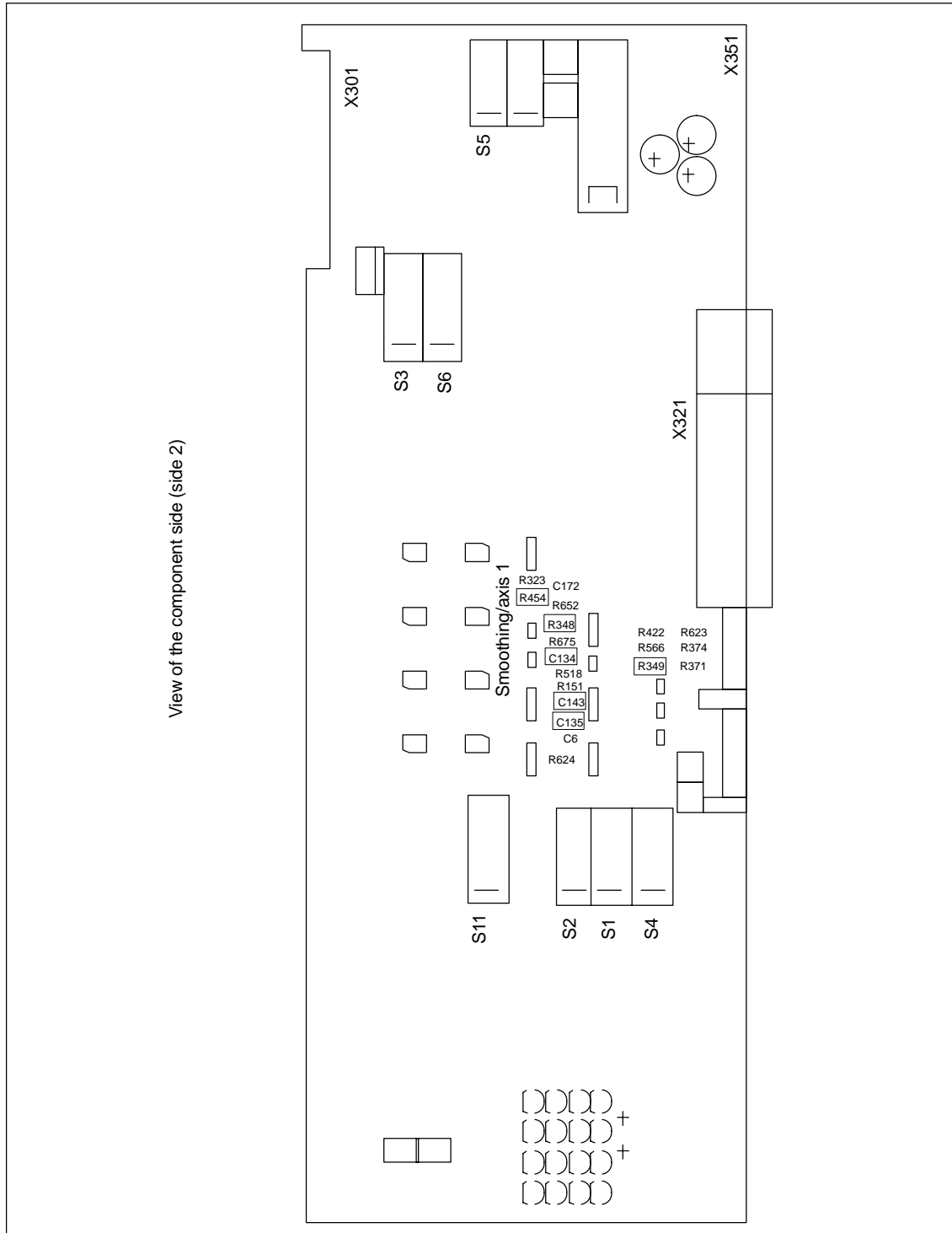

Fig. 9-1 Component side

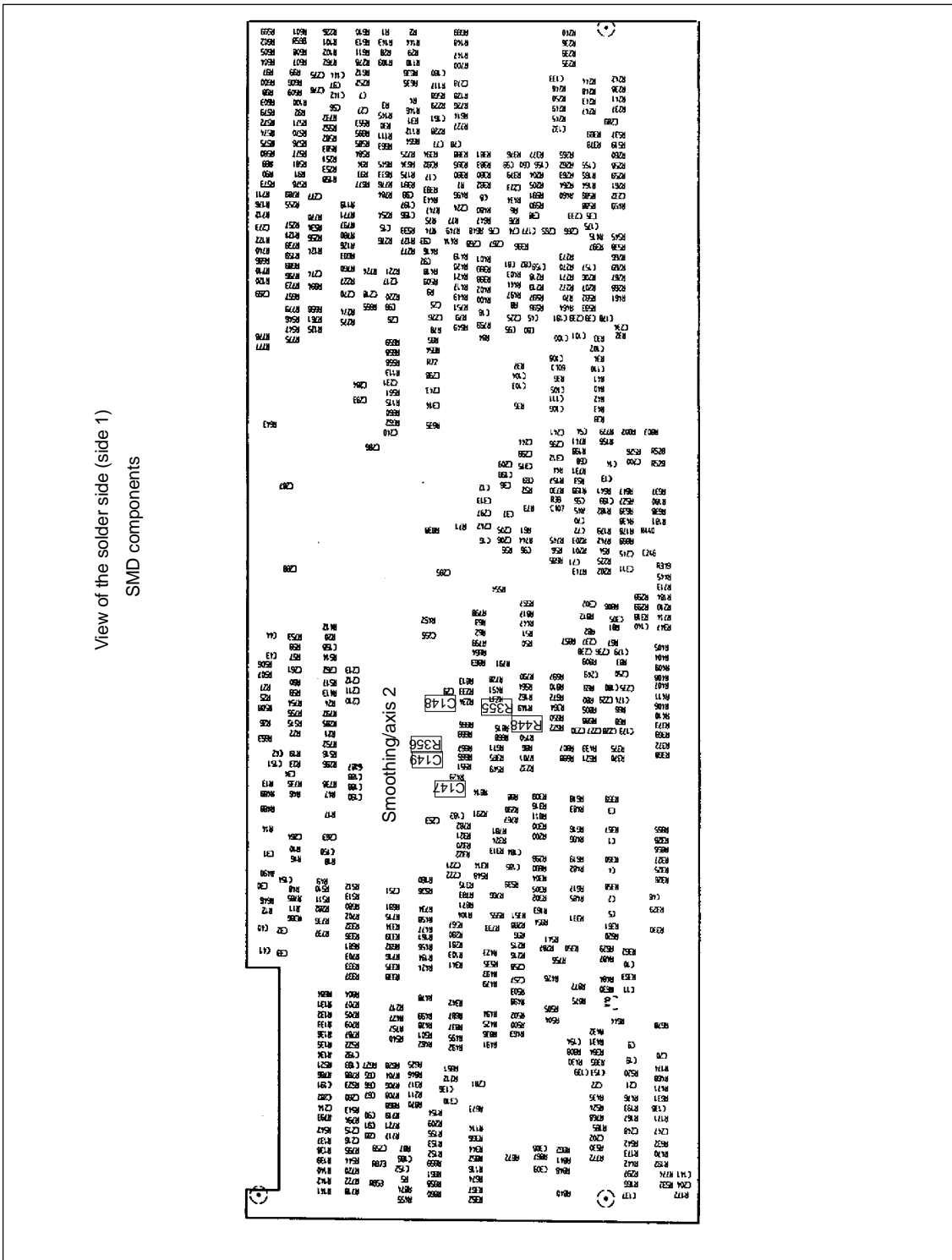

Fig. 9-2 Solder side

9.2 Layout diagrams

9.2.2 Layout diagram, DIL switch

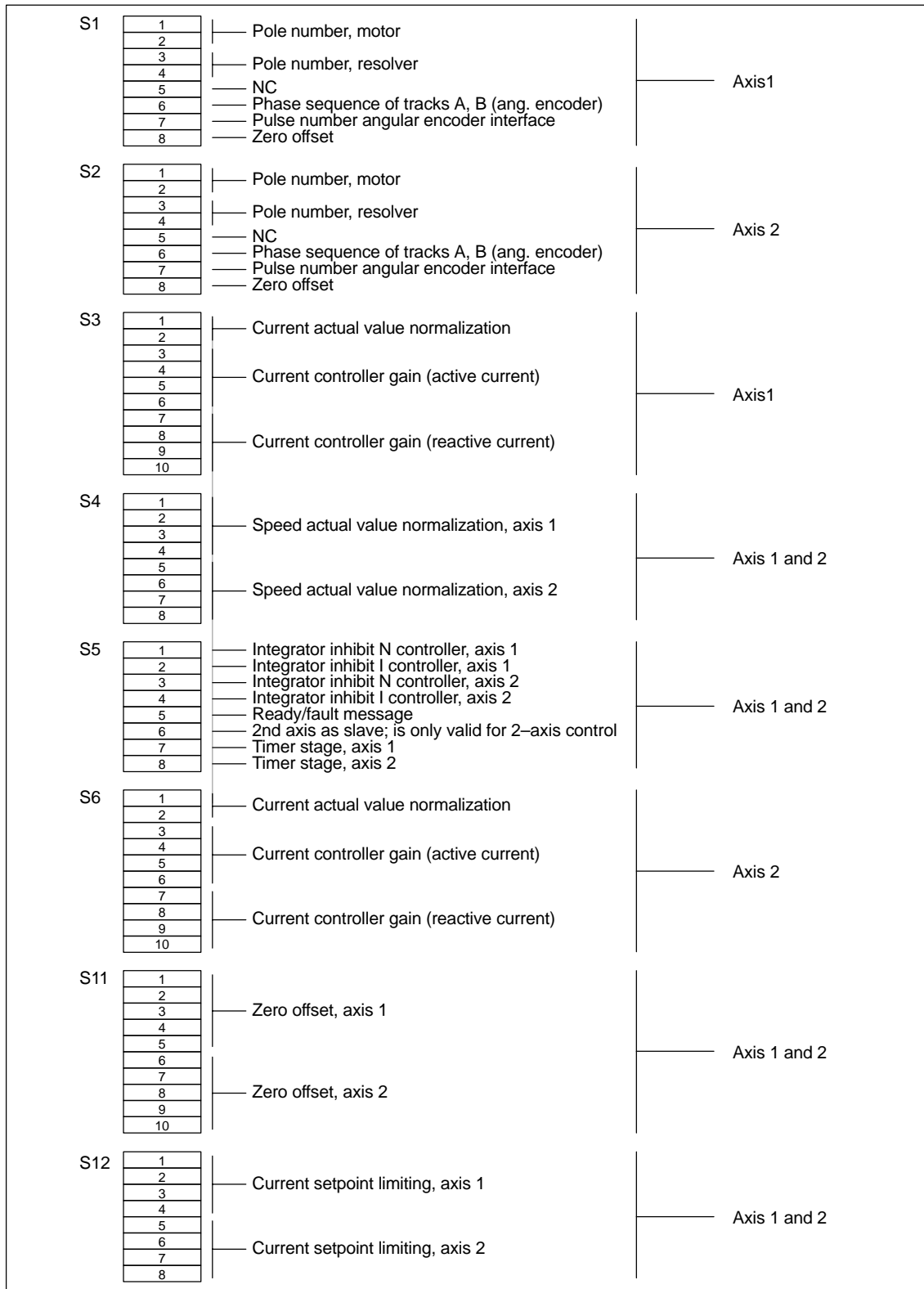

Fig. 9-3 DIL switch

9.3 Connector assignment

9.3.1 X311/X312, encoder interface axis 1/axis 2

Resolver control 25-pin subminiature D plug connector, screw locking UNC4-40
Connected via a pre-assembled cable

Table 9-3 Connector assignment X311/X312

Signal	Resolver control	Motor
SIN_PLUS	3	1
SIN_MINUS	4	2
M	5, 8, 24	-
COS_PLUS	6	11
COS_MINUS	7	12
RES_POS	9	10
RES_NEG	11	7
TEMP_PLUS	13	8
TEMP_MINUS	25	9

Refer to Section 3.4 for axes which are not used.

VR

9.3 Connector assignment

9.3.2 X391/X392, angular encoder interface, axis 1/axis 2

Resolver control

15-pin subminiature D plug connector, latch locking
Connected via a pre-assembled cable

Table 9-4 Connector assignment X391/X392

Signal	Comment	Type	Resolver control	Numeric	FM-NC
M	AEI ¹⁾	Ref. pin	2	11	-9
A	AEI ¹⁾	RS422A	3	1	-15
A_INV	AEI ¹⁾	RS422A	4	9	-14
B	AEI ¹⁾	RS422A	6	10	-13
B_INV	AEI ¹⁾	RS422A	7	3	-12
R	AEI ¹⁾	RS422A	12	4	-10
R_INV	AEI ¹⁾	RS422A	13	12	-11
READY	only X392 ²⁾	HCMOS !	1	NC	- NC
ER_IKL	Diagnostics ²⁾	HCMOS !	9	NC	- NC
ER_TNL	Diagnostics ²⁾	HCMOS !	10	NC	- NC
EN_WSG	Diagnostics ²⁾	HCMOS !	11	NC	- NC

1) Standard angular encoder interface (AEI), type: RS422A/driver: 75ALS192

**Warning**

- 2) The internal module signals for fault analysis!
These are not intended for use in external modules!



Index**A**

Adaptation tables, VR/1-5

C

Component side, VR/3-16, VR/9-30
 Connector assignment, VR/9-33
 Current actual value normalization, VR/1-5
 Current controller gain, VR/1-5
 Current controller settings, VR/1-5
 Current setpoint limiting, VR/3-15

D

Diagnostics, VR/8-27
 Drift compensation, VR/2-14

E

Electronic weight equalization, VR/3-17

F

Fault message, VR/3-16

G

Gain Kp, VR/2-13

I

Integral action time limiting, VR/3-16, VR/3-18
 Integral action time/Speed controller, VR/2-14
 Integrator inhibit, VR/3-16

L

Layout diagram, component side, VR/9-30
 Layout diagram, solder side, VR/9-31
 LED display, VR/8-27

M

Master/slave, VR/3-16, VR/3-17
 Mode of operation
 master speed controlled, VR/3-16, VR/3-18
 slave current controlled, VR/3-16, VR/3-17,
 VR/3-18
 Motion of operation, Master speed controlled,
 VR/3-17

P

Phase sequence of tracks A, B (WSG), VR/3-15
 Pole numbers, VR/1-3
 Position processing, VR/3-15
 Powering-up, VR/7-25
 Proportional gain Kp, VR/2-13
 Pulse number, angular encoder interface,
 VR/3-15

S

Service and diagnostics, VR/8-27
 Setpoint interfaces, VR/4-19
 Setting elements, with standard interface,
 VR/4-19, VR/4-20
 Setting the integral action time, VR/2-14
 Smoothing functions, VR/3-16
 Solder side, VR/3-16, VR/9-31
 Speed actual value normalization, VR/1-4
 Standard settings, VR/1-3
 Standard start-up, VR/1-3
 Start-up
 short start-up, VR/1-3
 standard start-up, VR/1-3

T

Tachometer calibration, VR/2-12
 Terminals, VR/9-29
 Test sockets, VR/8-27, VR/8-28
 Timer, VR/3-16
 TN (integral action time), VR/2-14

Z

Zero offset, VR/3-15

Space for notes

Main Spindle Modules (HS)

1	First Steps	HS/1-3
1.1	Start-up guidelines	HS/1-4
1.2	Start-up instructions	HS/1-7
1.3	Operator and display elements, control parameters	HS/1-8
1.4	Overview, setting data	HS/1-12
1.5	Connections	HS/1-13
2	Determining and Setting the System Configuration	HS/2-15
2.1	Motor and drive converter data sets	HS/2-15
2.1.1	System configuration with standard motors	HS/2-15
2.1.2	System configuration with special motors (non-catalog motors)	HS/2-17
2.1.3	System configuration with star/delta motors, 2 motors	HS/2-20
2.2	Standard applications	HS/2-25
2.2.1	Operating display	HS/2-25
2.2.2	Firmware version and module version	HS/2-26
2.2.3	Setting parameters for standard applications	HS/2-27
2.3	Additional applications	HS/2-30
2.3.1	Orientated spindle stop (using NC auxiliary function M19)	HS/2-30
2.3.2	C axis	HS/2-31
2.3.3	Spindle positioning	HS/2-31
2.3.4	Open-loop torque controlled mode (master/slave)	HS/2-44
2.3.5	Monitor function	HS/2-48
2.3.6	HPC axis (FW 2.00)	HS/2-48
2.3.7	Maximum current limiting (I2t limiting, from FW 3.1)	HS/2-54
3	Parameterizing the Drive Converter Interfaces	HS/3-55
3.1	Analog speed setpoint interface	HS/3-55
3.2	Input terminals	HS/3-58
3.2.1	Permanently-wired terminal functions	HS/3-58
3.2.2	Freely-programmable terminal functions	HS/3-59
3.3	Output terminals	HS/3-61
3.3.1	Permanently-wired relay functions	HS/3-61
3.3.2	Freely-programmable relay functions	HS/3-61
3.3.3	Variable relay function	HS/3-64
3.3.4	Motor encoder signals for NC	HS/3-65
3.3.5	Analog outputs	HS/3-66
4	Controller Optimization	HS/4-69
4.1	Speed controller optimization	HS/4-69
4.2	Current controller optimization	HS/4-75

HS

5	Diagnostics and Fault Analysis	HS/5-77
5.1	Diagnostic resources	HS/5-77
5.1.1	Measured value displays	HS/5-77
5.1.2	Status displays	HS/5-78
5.1.3	Diagnostic parameters	HS/5-81
5.1.4	Test sockets X1, X2, IR	HS/5-82
5.1.5	Minimum/maximum value memory	HS/5-84
5.1.6	Transient recorder function	HS/5-84
5.1.7	Current/Hz control	HS/5-86
5.2	Fault analysis	HS/5-87
5.2.1	Fault display, fault acknowledgement	HS/5-87
5.2.2	Fault message list	HS/5-88
6	Attachment	HS/6-93
6.1	Flow diagram for short start-up	HS/6-94
6.2	Code numbers for power modules and standard motors	HS/6-99
6.3	Overview of connections	HS/6-103
6.4	Connector assignments	HS/6-108
6.5	Addresses, RAM variables	HS/6-112
6.6	Setting and monitoring data (parameter list)	HS/6-113

First Steps

1



Warning

Perfect and safe operation of this equipment assumes that it is professionally transported, professional stored, installed and mounted as well as careful operator control and service.

If this warning information is not observed, this can result in severe bodily injury or material damage.



The modules contain components which can be destroyed by electrostatic discharge. Please observe the ESDS information in the foreword.

Note

The module Order No. [MLFB] 6SN1121-0BA11-0AA1 can only be used with firmware from 3.00.

The modules, Order No. [MLFB]:
 6SN1121-0BA11-0AA0
 6SN1121-0BA12-0AA0
 6SN1121-0BA13-0AA0
 can only be used up to firmware 2.xx.

Note

Start-up software is available to commission the main spindle motor control with analog setpoint interface.

Ordering data for software:
 Refer to Catalog NC 60
 Order No.: E86060-K4460-A101-A8

Ordering data for documentation:
 Start-up software for main spindle and induction motor modules
 Order No. 6SN1197-0AA30-0AP1

Note

Motor definition

Standard motor:	The motors are listed in the Siemens Catalog.
Third-party motor:	Motors manufactured by companies other than Siemens.
Special motor:	Motor manufactured by Siemens to special customer specifications.

1.1 Start-up guidelines

Structure of the Start-up Guide

The Start-up Guide is structured in the sequence of the actual start-up steps.

When commissioning systems for standard applications, where the drive converter interfaces (Section 1.5) and controller optimization settings when supplied are generally adequate, only the start-up steps which are printed in bold, are of significance.

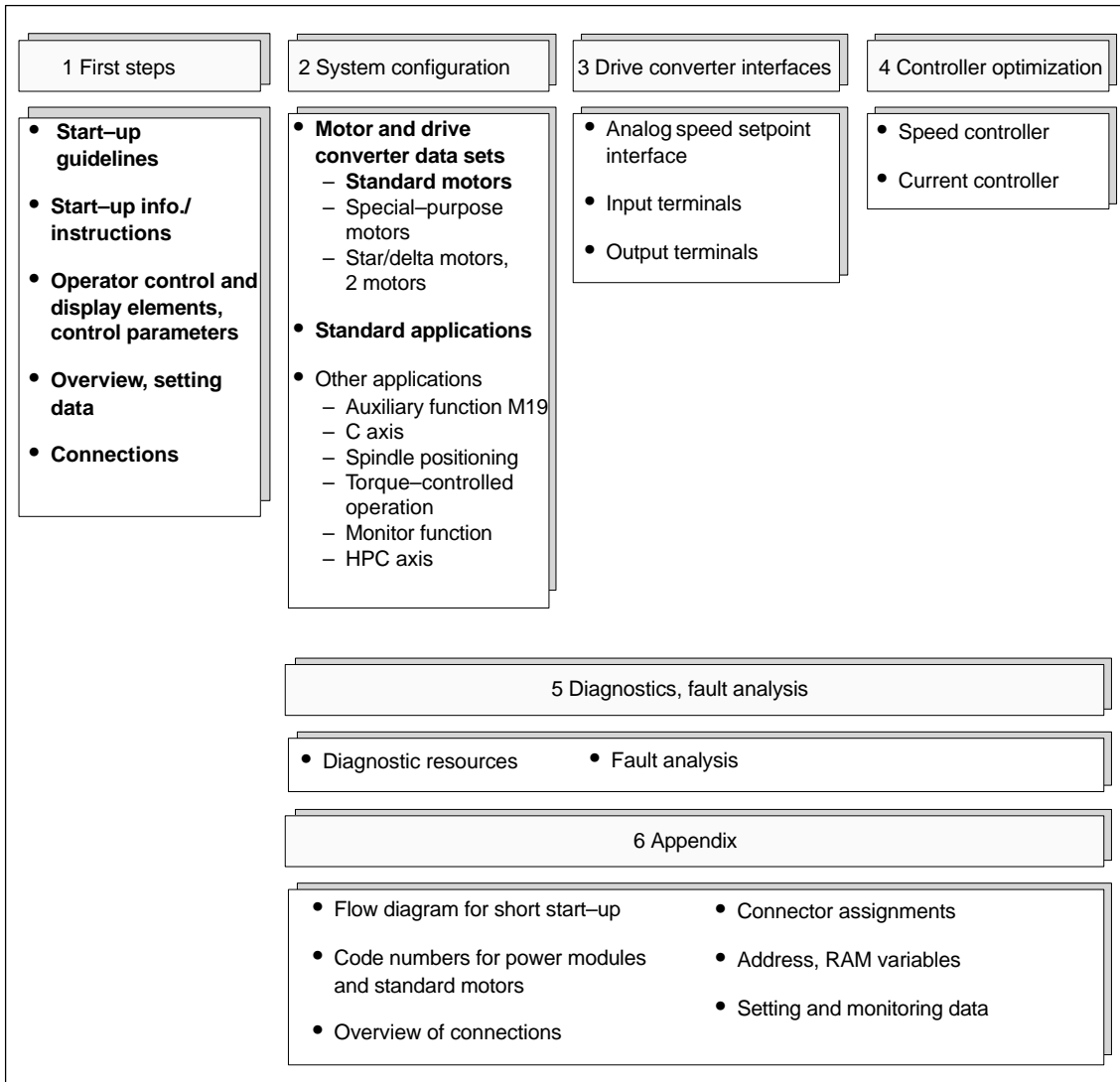

Fig. 1-1 Start-up steps

Parameter list



Warning

The settings of parameters, which are not in the parameter list (refer to Section 6.6), may not be changed.

The parameter descriptions are information units, in the form of tables.

The parameter sequence represents the procedure when parameterizing the equipment.

Table 1-1 Example of a parameter list

Parameter attributes			P-051	Setting range	Description
Number	Change becomes effective				
Mot. 1	Mot. 2				
P-040.1	P-270.1	Online, RESET, after initialization, after conversion	4 10	Value range Dimensions	Parameter name Brief parameter description FW x.xx

HS

Parameter attributes

- **Number**
 - Mot. 1
generally valid parameters,
parameters for motor 1 (star) when using star/delta motors or 2 motors
 - Mot. 2
parameters for motor 2 (delta) when using star/delta motors or 2 motors
 - (P-001)
display parameters
 - P-040.1
gearbox-stage dependent parameters

1.1 Start-up guidelines

- **Changes becomes effective**
 - online
Change immediately becomes effective
 - RESET
The unit must be powered-down and up again
 - after conversion
A conversion program is initiated by setting to 1H; the parameter can then be automatically reset to 0H (P-143, P-177, P-237, P-239).
 - after initialization
Initialization is initiated by setting P-097 to 1H.
- **P-051**
Write-protected parameters
Write protection is removed by entering 4H or 10H

Setting range

For several control words, the functions are activated by setting bits.

Example: Bit 8 0100H or bit 6 0040H
 Bit 9 0200H or bit 7 0080H

A combination of several functions is entered in the form of hexadecimal additions.

Example: Bit 8 + bit 9 0300H or bit 6 + bit 7 00C0H

Description

- **FW x.xx**
Firmware release-dependent coding of function and parameter extensions.
The extension is available from the specified firmware release onwards.

1.2 Start-up instructions

Start-up

Using

- Operator control and display elements (refer to Section 1.3)
- RS232C interface with an IBM AT-compatible computer and start-up software (refer to the foreword)

Re-initializing the drive converter (if required)

If an already initialized drive converter is to be re-initialized, then the following procedure must be followed:

- If required, save the setting data (parameters)
- Remove the write protection: Set **P-051** to 4H
- Start initialization: Set **P-097** to 0H
- Overwrite the parameters in the drive-machine data memory: Set **P-052** to 1H and wait until **P-052** resets itself back to 0H.
- Power-on reset:
Power-down the unit and approx. 2 s after the display has gone dark, power-up the unit again: **P-095** or **P-096** must be displayed.
- Initialize (Section 2.1)

Replacing firmware (if necessary)

From version V2.00, the firmware can be replaced using the user-prompted start-up software for main spindle and induction motor modules.

Firmware release	Module
Before FW 3.00	6SN1121-0BA1□-0AA0
From FW 3.00	6SN1121-0BA11-0AA1

Procedure:

- Save the setting data (parameters)
- Replace the firmware using the start-up program
- Initialize with the pulses and controller inhibited (Section 2.1)
- Re-load the setting data (parameters) which was saved
- Save the setting data in the drive-machine data memory (Section 1.3)

Starting-up series machines, replacing modules, replacing components

The drive converter setting data (parameters) can be saved on floppy disk using the start-up software. The following procedure must be maintained for series start-up of additional drive converters:

1. – Initialize with the pulses and controller inhibited:
Enter P-095, power module code according to Tab. 6-1. ¹⁾
– The motor code number and motor encoder pulse number are saved on the floppy disk, which means that they do not have to be entered.
– Start initialization.
2. Load the setting data from the floppy disk and save.

1) From FW 3.00, power modules with Order No. [MLFB] 6SN112□-1A□0□-□□A1, are automatically recognized. It is then no longer possible/necessary to enter P-095.

1.3 Operator and display elements, control parameters

Operator and display elements

The following operator and display elements are provided on the front panel to start-up and parameterize the SIMODRIVE 611 analog system MSD module:

- 3 operator keys (**+**, **P** and **-** key)
- 6-digit LCD display

The operator element functions are shown using as an example, parameter P-039.

Gearbox-stage dependent parameters are listed with sub-parameter numbers (e.g. **P-039.1** to **P-039.8**).

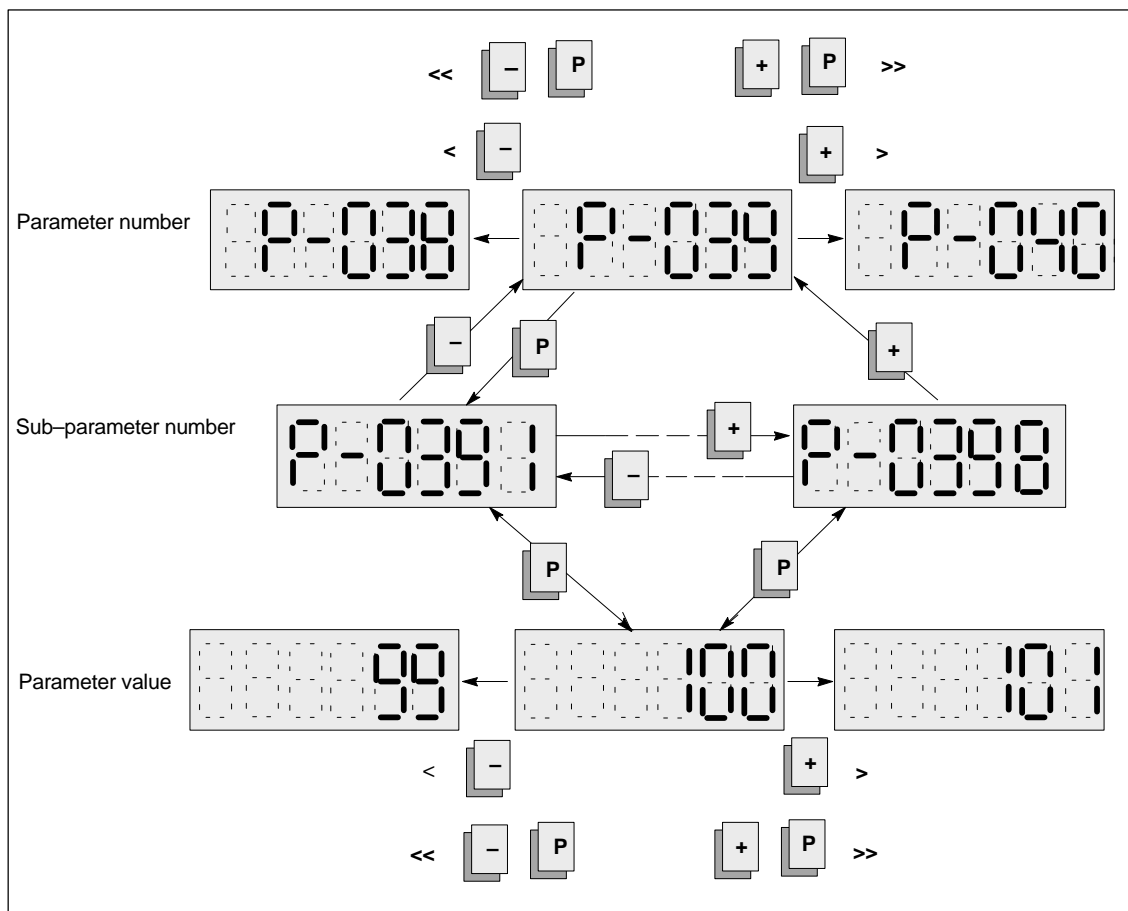

Control parameters

Note

If data save (**P-052**) is interrupted due to power failure or power-down, then the modified values are lost, and the drive converter displays fault message "F-07" after it is powered-up again. The parameter values can be re-set after fault message "F-07" has been acknowledged (refer to Section 5.2.2).

Table 1-2 Control parameters

Parameter attributes				Setting range	Description																		
Number	Change effective	P-051																					
Mot. 1	Mot. 2																						
P-051 P-151	–	Online	–	0..7FFF hex	Write protection Write protection is removed by entering 4H or 10H.																		
P-052 P-152	–	Online	4	0...1 hex	Transferring parameters into the FEPRM Parameters are transferred into the drive-machine data memory by setting to 1H. The parameter is reset to 0H after transfer.																		
P-053	–	Online	4	0...FFFF hex	Control word																		
					Bit	Value																	
					0	0000H	Ready relay pulls-in if there is no fault and the pulses and controller are enabled. The ready relay pulls-in if there is no fault.																
						0001H																	
					1	0000H	For a ramp-function generator fast stop, the speed setpoint is digitally set to zero but the motor remains magnetized. The pulses are cancelled after the drive has been shut down.																
						0002H																	
					4	0000H	Speed setpoint smoothing inactive Speed setpoint smoothing active																
0010H																							
5	0000H	Speed actual value smoothing inactive Speed actual value smoothing active, if at the same time P090 bit 3=0 FW 3.0																					
	0020H																						
8 9 10					<table border="1"> <thead> <tr> <th>Bit 10/Bit 9/Bit 8</th> <th>Inverter clock cycle frequency [kHz]</th> </tr> </thead> <tbody> <tr> <td>0000H</td> <td>3.2</td> </tr> <tr> <td>0100H</td> <td>2.8 FW 3.0</td> </tr> <tr> <td>0200H</td> <td>6.3</td> </tr> <tr> <td>0300H</td> <td>5.0 FW 3.0</td> </tr> <tr> <td>0400H</td> <td>4.7</td> </tr> <tr> <td>0500H</td> <td>3.9 FW 3.0</td> </tr> <tr> <td>0600H</td> <td>7.8</td> </tr> <tr> <td>0700H</td> <td>5.9 FW 3.0</td> </tr> </tbody> </table>	Bit 10/Bit 9/Bit 8	Inverter clock cycle frequency [kHz]	0000H	3.2	0100H	2.8 FW 3.0	0200H	6.3	0300H	5.0 FW 3.0	0400H	4.7	0500H	3.9 FW 3.0	0600H	7.8	0700H	5.9 FW 3.0
					Bit 10/Bit 9/Bit 8	Inverter clock cycle frequency [kHz]																	
					0000H	3.2																	
					0100H	2.8 FW 3.0																	
					0200H	6.3																	
					0300H	5.0 FW 3.0																	
					0400H	4.7																	
0500H	3.9 FW 3.0																						
0600H	7.8																						
0700H	5.9 FW 3.0																						
Note: A pulse frequency > 3.2 kHz is only possible if the drive is de-rated (refer to Table 1-3).																							

HS

1.3 Operator and display elements, control parameters

Table 1-2 Control parameters

Parameter attributes		Change effective	P-051	Setting range	Description		
Number Mot. 1	Mot. 2						
P-053			4		11	0000H 0800H	Fault message F-79 not suppressed, Fault message F-79 suppressed
					12	0000H 1000H	Ramp-function generator tracking active Ramp-function generator tracking inactive
					13	0000H 2000H	Bipolar speed setpoint evaluation Unipolar speed setpoint evaluation FW 2.00
					15	0000H 8000H	Cyclic parameter number display active Cyclic parameter number display inactive FW 3.0
P-090	-	Online	10	0...FFFF hex	Control word		
					Bit	Value	
					0	0000H 0001H	Parameter format hex display Parameter format dec display CAUTION! Parameter setting limits are not effective in the hex format!
					1	0000H 0002H	Fault message F-09 activated Fault message F-09 suppressed FW 2.00
	RESET	10		3	0000H 0008H	Speed controller clock cycle [µs] Normal operation 1000 HPC axis without filter 500 with filter 600 Possible from FW 3.0 Normal operation 525 HPC axis without filter 300 with filter 350 Bit 3 can only be changed after first saving on the FEPRM and then power-off/power-on	
						Online	10
	5	0000H 0020H	Fault message F-18 suppressed Fault message F-18 active (FW 3.00)				
	6	0000H 0040H	Integrator, speed controller when limiting is set to the difference between the torque limit and P component Integrator, speed controller held when limiting, FW 2.00				
	RESET	10		8	0100H	A basic flux model is switched-in by setting this bit. This results in faster and more uniform acceleration if the drive starts with a speed setpoint when the controller is enabled.	
			RESET	10		9	0000H 0200H

1.3 Operator and display elements, control parameters

Various inverter clock cycle frequencies can be parameterized; please observe the appropriate current de-rating.

Table 1-3 Currents as a function of the inverter clock cycle frequency, MSD analog f_T

Power module type	Order Nos. 6SN1123-1AA0□- 6SN1124-1AA0□- 6SN1135-1BA1□-	Code No.	In/Is6/Imax in A	In/Is6/Imax in A	In/Is6/Imax in A	In/Is6/Imax in A
			$f_T=3.20$ kHz	$f_T=4.70$ kHz	$f_T=6.30$ kHz	$f_T=7.80$ kHz
50 A	-OCA□	6	24/32/32	20/26/26	15/20/20	10/14/14
80 A	-ODA□	7	30/40/51	26/34/44	21/28/36/	17/23/29
108 A	-OLA□	13	45/60/76	39/52/65	32/43/54	26/34/43
120 A	-OGA□	8	45/60/76	39/52/65	32/43/54	26/34/43
160 A	-OEA□	9	60/80/102	51/68/86	41/54/69	31/42/53
200 A	-OFA□	10	85/110/127	73/95/109/	60/78/90	48/63/72
300 A	-OJA□	11	120/150/193	101/127/163	81/102/131/	62/78/101
400 A	-OKA□	12	200/250/257	169/211/217	135/169/174	104/130/134
From FW 3.00						
Power module type	Order Nos. 6SN1123-1AA0□- 6SN1124-1AA0□- 6SN1135-1BA1□-	Code No.	In/Is6/Imax in A	In/Is6/Imax in A	In/Is6/Imax in A	In/Is6/Imax in A
			$f_T=2.80$ kHz	$f_T=3.90$ kHz	$f_T=5.00$ kHz	$f_T=5.90$ kHz
50 A	-OCA□	6	24/32/32	22/29/29	19/25/25	16/21/21
80 A	-ODA□	7	30/40/51	28/37/48	25/33/42	22/30/38
108 A	-OLA□	13	45/60/76	42/56/71	37/50/63	34/45/57
120 A	-OGA□	8	45/60/76	42/56/71	37/50/63	34/45/57
160 A	-OEA□	9	60/80/102	56/74/95	49/65/83	43/58/73
200 A	-OFA□	10	85/110/127	79/103/119	71/91/106	63/82/95
300 A	-OJA□	11	120/150/193	111/139/179	98/122/157	86/108/139
400 A	-OKA□	12	200/250/257	185/232/238	163/203/209	144/180/185

HS

1.4 Overview, setting data

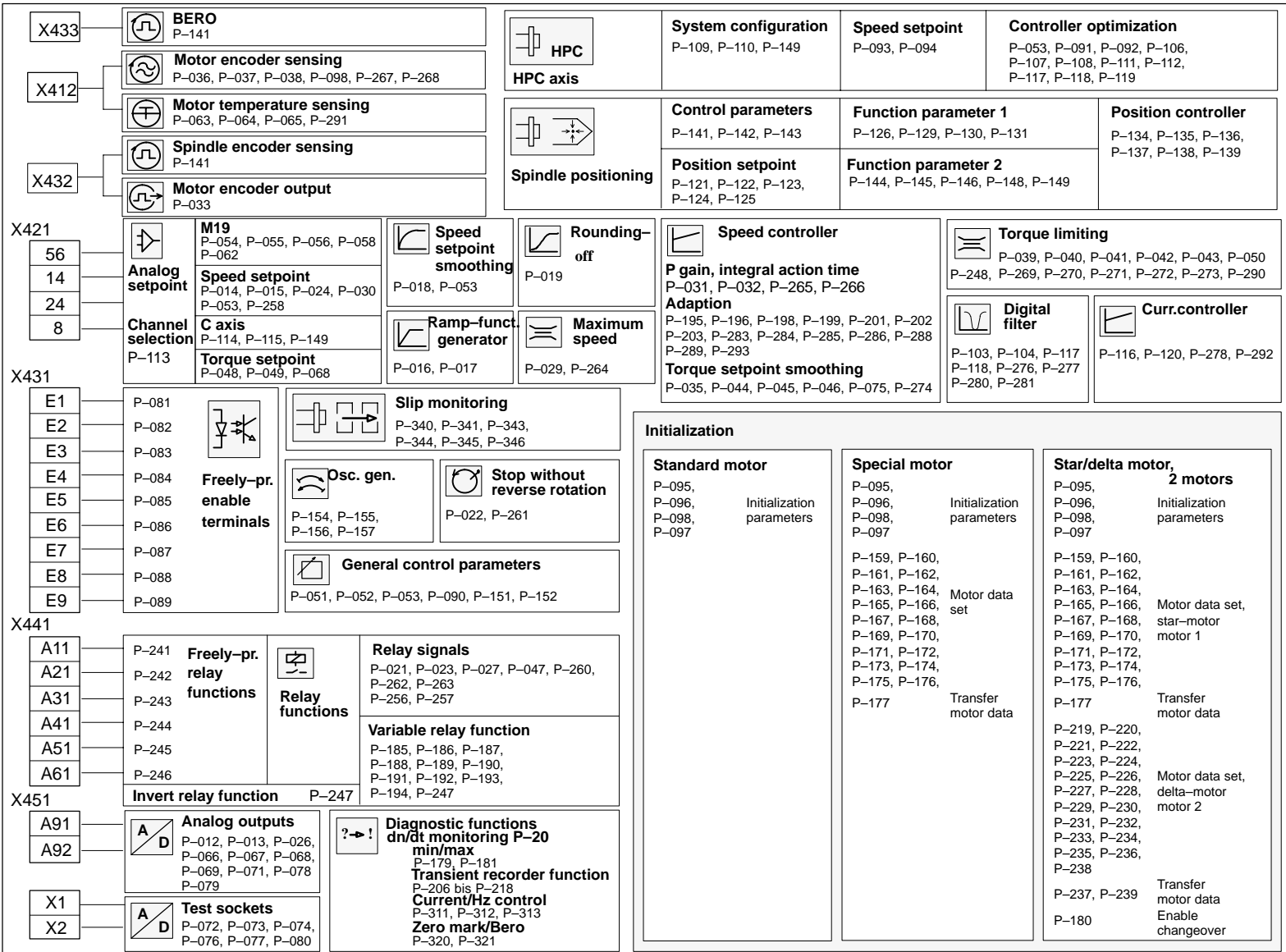
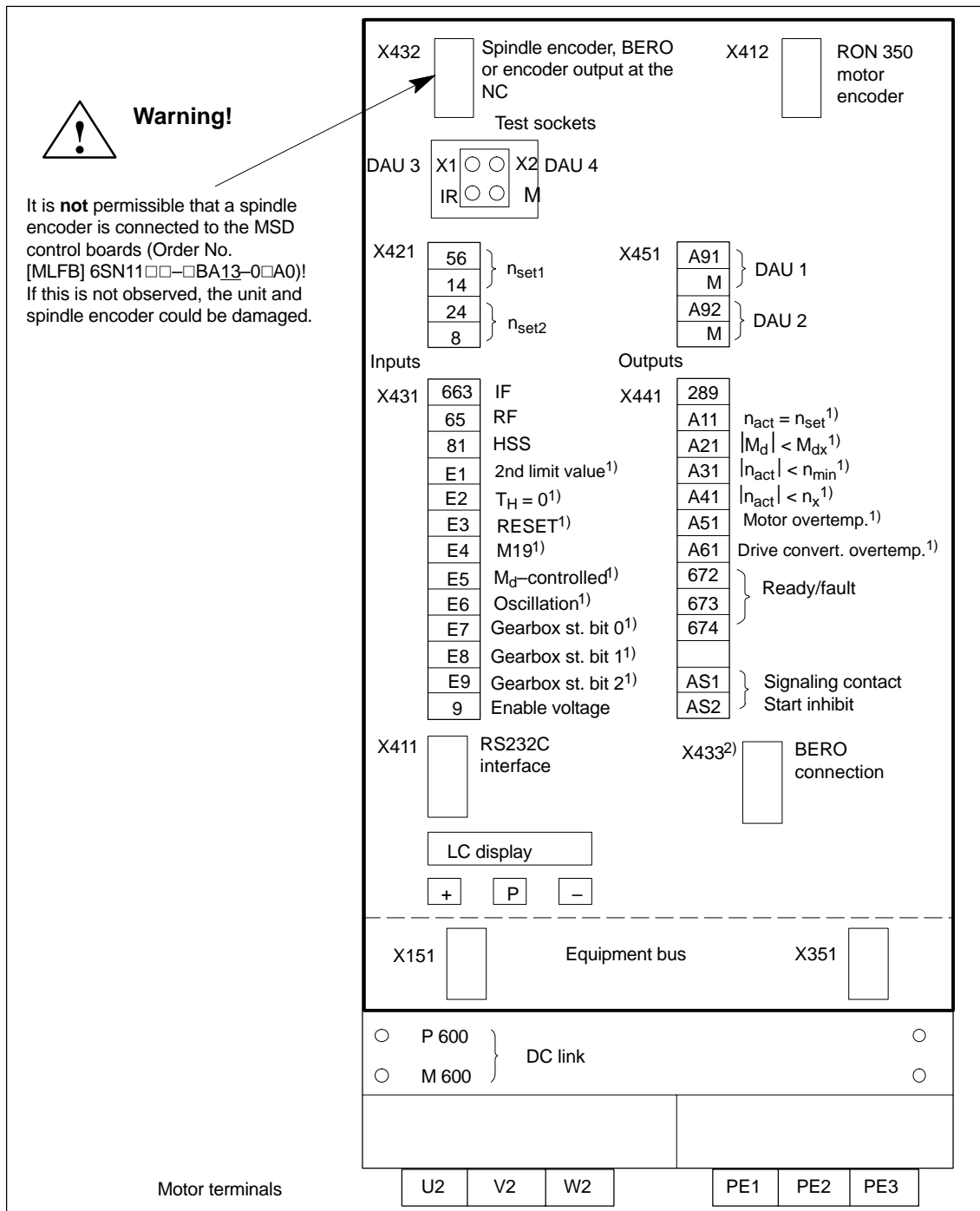

Fig. 1-2 Setting data

1.5 Connections



HS

Fig. 1-3 Connections

1) Freely-programmable terminals and relay functions as supplied
 2) Only for Order No. [MLFB] 6SN1121-0BA11-0AA1

Determining and Setting the System Configuration

2



Warning

Incorrect setting values in **P-098** can cause the motor to accelerate up to inadmissibly high speeds and terminal 64 (NE) and terminal 65 (controller inhibit) are ineffective. Only terminal 663 (axis-specific pulse cancellation) "open" is effective.

2.1 Motor and drive converter data sets

HS

2.1.1 System configuration with standard motors

Initialization

Table 2-1 Initialization

Parameter attributes				P-051	Setting range	Description
Number		Change effective				
Mot. 1	Mot. 2					
P-095	–	After initialization	–	6...13 dec	Power module code number Default: 7 (Section 6.2) from FW 3.00 Default: 3 ¹⁾	
P-096	–	After initialization	–	101...429 dec	Motor code number Default: 101 (Section 6.2)	
P-098	–	After initialization	–	128...4096 dec	Encoder pulse number, motor measuring system Default: 2048 for 1PH4, 1PH6 Adapt for 1PH2 and toothed-wheel encoder.	
P-097	–	–	–	0...1 hex	Initialization "SEtUP" message is displayed. The selected motor/power module combination is loaded into the drive-machine data memory. "P-000" is displayed after successful initialization on the operating display.	

1) Power modules (LT) with Order No. [MLFB] 6SN12□-1A□0□-□□A1 are automatically recognized from FW 3.00. It is then not possible to change P-095.

2.1 Motor and drive converter data sets

Operation with an uncontrolled infeed

Table 2-2 Operation with an uncontrolled infeed (UE)

Parameter attributes			P-051	Setting range	Description
Number Mot. 1	Mot. 2	Change effective			
P-173	–	After conversion	10	100...6000 RPM	Speed at the start of field weakening Multiplies the initialized value by the factor $V_{\text{supply}} \cdot 0.002 \left(\frac{1}{V}\right)^2$ (corresp. to 0.8 for $V_{\text{supply}}=400$ V)
P-176	–	After conversion	10	1...150 %	Stall torque reduction factor Multiplies the initialized value by the factor $V_{\text{supply}} \cdot 0.002 \left(\frac{1}{V}\right)^2$ (corresponds to 0.64 for $V_{\text{supply}}=400$ V)
P-177	–	Online	10	0...1 hex	Start calculation, motor The calculation for the entered motor is started. “99” is entered into P-096
P-052	–	Online	4	0...1 hex	Parameter transfer into the FEPR0M

2.1.2 System configuration with special motors (non-catalog motors)

Note

When using special motors, the motor data must be discussed with the responsible SIEMENS office.

Overview

- Initializing special motors
- Motor data set
- Characteristics for flux setpoint and main field inductance

Initializing special motors

If a non-catalog motor is to be loaded, then initially, a standard motor (motor numbers 101 to 429) should be initialized, whose motor data approximately correspond to those of the non-catalog motor. Starting from these motor data, the required changes can be made for motor 1 in the range P-158 to P-176.

The required calculation is started with P-177=1. After the calculation has been completed, 0 is written back into P-177. P-052 is set to 1 H to save the data.

HS

Table 2-3 Initializing special motors

Parameter attributes				Setting range	Description
Number	Change effective	P-051			
Mot. 1	Mot. 2				
P-095	–	After initialization	–	6...13 dec	Power module code number Default: 7 (Section 6.2) from FW 3.00 Default: 3 ¹⁾
P-096	–	After initialization	–	101...429 dec	Motor code number Default: 101 (Section 6.2) The motor code number of a standard motor is entered, whose motor data approximately correspond to those of the special motor.
P-098	–	After initialization	–	128...4096 dec	Encoder pulse number – motor measuring system Default: 2048
P-097	–	–	–	0...1 hex	Initialization “SETUP” message is displayed. The motor/power module combination selected is loaded into the drive-machine data memory. “P-000” is displayed in the operating display after successful initialization.

1) Power modules with Order No. [MLFB] 6SN112□-1A□□□-□□A1 are automatically recognized from FW 3.00. It is then not possible to change P-095.

2.1 Motor and drive converter data sets

Motor data set For special motors, the motor data must be entered. The list of motor data (P-159 to P-176) is provided in Section 6.6.

Table 2-4 Motor data set

Parameter attributes			P-051	Setting range	Description
Number Mot. 1	Mot. 2	Change effective			
P-158	–	Online	4	0.000 mH...65.535 mH	From FW 3.00 Low-leakage motors require a series reactor to smooth the phase currents. The series reactor acts on the drive converter just like an increased leakage stator reactance P169/229 . Previously, P169/P229 had to be manually adapted. P158 and P294 influence the stall limiting and the pre-assignment of the current controller.
P-159 to P-176	–	After con- version	10	Refer to Section 6.6	Motor data for motor 1 Motor data are entered for the special motor
P-177	–	Online	10	0...1 hex	Start calculation, motor 1 (P-096) The calculations are started for the special motor which was entered. "99" is entered in P-096.
P-052	–	Online	4	0...1 hex	Parameters transfer into the FEPROM

Flux setpoint and main field inductance characteristic

Table 2-5 Flux setpoint and main field inductance characteristic

Parameter attributes			P-051	Setting range	Description
Number	Change effective				
Mot. 1	Mot. 2				
P-172	–	After conversion	10	10...10000 RPM	Upper speed L_h characteristic (magnetizing inductance characteristic)
P-173	–	After conversion	10	100...6000 RPM	Speed at the start of field weakening Speed at start of field weakening for the flux setpoint charac. and lower speed for L _h characteristic When operating the converter from an uncontrolled infeed, the determined speed should be multiplied by the factor $V_{supply} \cdot 0.002 \frac{1}{V}$ (corresponds to 0.8 for V _{supply} =400V)
P-175	–	After conversion	10	100...300 %	Gain factor, L_h characteristic $P-175 = \frac{L_{h2} \text{ (at } n=P-172)}{L_{h1} \text{ (at } n=P-173)} \cdot 100 \%$ 100 % = constant L _h over the complete speed range
P-176	–	After conversion	10	1...150 %	Stall torque reduction factor Speed at the start of the stall torque limit: P-176 > 100 %: Increases the intervention point P-176 < 100 %: Reduces the intervention point When operating the converter from an uncontrolled infeed, the determined speed should be multiplied by the factor $(V_{supply} \cdot 0.002 \frac{1}{V})^2$ (corresponds to 0.64 for V _{supply} =400 V)

HS

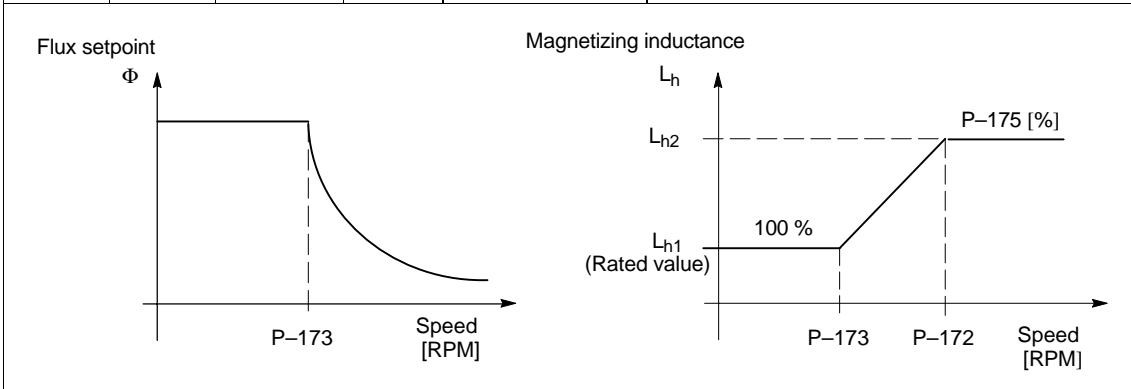

2.1.3 System configuration with star/delta motors, 2 motors

Note

When using special motors, the motor data must be discussed with the responsible SIEMENS office.

Overview

- Initializing star/delta motors, 2 motors
- Motor data sets
- Flux setpoint and magnetizing reactance characteristic
- Motor changeover

**Initializing star/
delta standard
motors**

In this case, when initializing, the number of the star motor (even number) should be entered in the range between 200 and 299 into parameter P-096.

The required calculations are automatically made when selecting the initialized function (P-097=1).

**Initializing two
different standard
motors**

If two different standard motors are to be loaded, then initially, a standard motor (motor number 101 to 429) should be initialized. This motor data is displayed in the parameter range for motor 1 (star) P-158 to P-176.

After initialization, the motor number for motor 2 (delta) must be entered into P-238, and the required calculations started with P-239 = 1. This motor data must be displayed in the range P-219 to P-236 and P-294.

Initializing star/ delta motors, 2 motors

Table 2-6 Initializing star/delta motors, 2 motors

Parameter attributes				Setting range	Description
Number Mot. 1	Mot. 2	Change effective	P-051		
P-095	–	After initialization	–	6...13 dec	Power module code number Default: 7 (Section 6.2) from FW 3.00 Default: 3 ¹⁾
P-096	–	After initialization	–	101...429 dec	Motor code number Default: 101 (Section 6.2) The following motor code number should be entered depending on the system configuration: Star/delta standard motor The even (star motor) motor code number is entered Star/delta special motor An even motor code number of a standard motor (star) is entered, whose motor data approximately correspond to those of the special motor. 2 standard motors The motor code number of the 1st standard motor is entered 2 special motors A motor code number of a standard motor is entered, whose motor data approximately correspond to those of the 1st special motor.
P-098	–	After initialization	–	128...4096 dec	Encoder pulse number – motor measuring system Default: 2048
P-097	–	–	–	0...1 hex	Initializing “SEtUP” message is displayed. The selected motor/power module combination is loaded in the drive-machine data memory. “P-000” is displayed after successful initialization in the operating display .
–	P-238	After con- version	10	101...429 dec	Motor code number Pre-setting: 101 (Section 6.2) The motor code number for the 2nd motor (delta) is entered according to the system configuration. Proceed as for P-096.
–	P-239	Online	10	0...1 hex	Start calculation, motor 2 (P-238)
P-052	–	Online	4	0...1 hex	Parameter transfer into the FEPR0M

1) Power modules (LT) with Order No. [MLFB] 6SN12□-1A□□□-□□A1 are automatically recognized from FW 3.00.
It is then not possible to change P-095.

2.1 Motor and drive converter data sets

**Motor data sets
special motors**

For special motors, the motor data must be entered. The list of motor data sets is provided in the Attachment (refer to Section 6.6).

- **P–158 to P–176** star motor data and data set, motor 1
- **P–294, P–219 to P–236** delta motor data and data set, motor 2

Table 2-7 Motor data sets

Parameter attributes				Setting range	Description
Number Mot. 1	Number Mot. 2	Change effective	P–051		
P–159 to P–176	P–219 to P–236	After con- version	10	Refer to Section 6.6	Motor data for motor 1/motor 2 The motor data is entered depending on the system configuration: Star/delta standard motor Data does not have to be entered Star/delta special motor Motor data is entered for star (P–159 to P–176) and delta (P–219 to P–236) 2 standard motors Data does not have to be entered 2 special motors Motor data is entered for the 1st special motor (P–159 to P–176) and 2nd special motor (P–219 to P–236)
P–158	P294	Online	4	0.000 mH...65.535 mH	From FW 3.00 Low-leakage motors require that a series reactor is used to smooth the phase currents. The series reactor acts on the drive converter just like an increased leakage stator reactance P169/229 . Previously, P169/P229 had to be manually adapted. P158 and P294 influence the stall limiting and the pre-assignment of the current controller.
P–177	P–237	Online	10	0...1 hex	Start calculation motor 1(P–096)/motor 2 (P–238) The calculations are started for the special motor which was entered if P–180 = 0.
P–052	–	Online	4	0...1 hex	Parameter transfer into the FEPR0M

**Flux setpoint
and main field
inductance
characteristic**

Table 2-8 Flux setpoint and main field inductance characteristic

Parameter attributes		Change effective	P-051	Setting range	Description
Number Mot. 1	Number Mot. 2				
P-172	P-232	After conversion	10	10...10000 RPM	Upper speed L_h characteristic (magnetizing inductance characteristic)
P-173	P-233	After conversion	10	100...6000 RPM	Speed at the start of field weakening Speed at the start of field weakening for the flux setpoint characteristic and lower speed for L_h characteristic When operating the converter from an uncontrolled infeed, the determined speed should be multiplied by the factor $V_{supply} \cdot 0.002 \frac{1}{V}$ (corresponds to 0.8 for $V_{supply}=400V$)
P-175	P-235	After conversion	10	100...300 %	Gain factor, L_h characteristic $P-175 = \frac{L_{h2} \text{ (for } n=P-172)}{L_{h1} \text{ (for } n=P-173)} \cdot 100 \%$ 100 % = constant L_h over the compl. speed range
P-176	P-236	After conversion	10	1...150 %	Stall torque reduction factor Speed at the start of the stall torque limit: P-176 > 100 %: Increases the intervention point P-176 < 100 %: Decreases the intervention point When operating the converter from an uncontrolled infeed, the determined speed should be multiplied by the factor $(V_{supply} \cdot 0.002 \frac{1}{V})^2$ (corresponds to 0.64 for $V_{supply}=400V$) P-176/P-236 will be loaded for specific motors from FW 3.10 onwards.
P-178	P-240	-	-	Display parameter	Displays the speed, above which the rated output must be reduced due to the stall torque limiting, from FW 3.10

HS

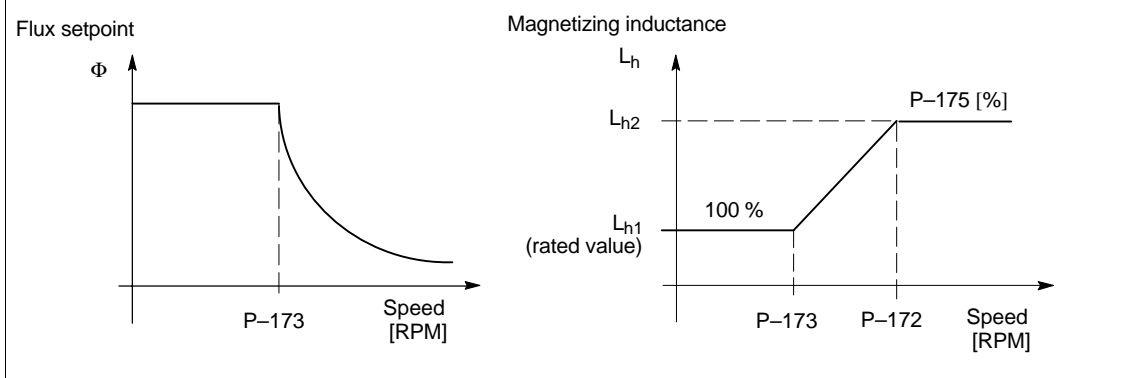

2.1 Motor and drive converter data sets

**Motor
changeover**

Table 2-9 Motor changeover

Parameter attributes				P-051	Setting range	Description
Number		Change effective	Mot. 1			
Mot. 1	Mot. 2					
P-180	–	Online	10	0...1 hex	Enable motor changeover (star/delta) 0H: No motor changeover possible 1H: Motor changeover enabled Note: A freely programmable input terminal (E1 to E9) must be assigned function number 5 for the changeover request (parameterization, Section 3.2.2)	

2.2 Standard applications

2.2.1 Operating display

The actual operating status of the unit is displayed in parameters **P-000** and **P-100**.

Table 2-10 Operating display

Display					
Function group					
	Relay functions	Mode	Equipment status	Mode	Gearbox stage
In-active	<ul style="list-style-type: none"> <input type="checkbox"/> Free-progr. relay function 1 terminal A11 P-241 $n_{act} = n_{set1}^1$ <input type="checkbox"/> Free-progr. relay function 2 terminal A21 P-242 $M_d < M_{dx}^1$ <input type="checkbox"/> Free-progr. relay function 3 terminal A31 P-243 $n_{act} < n_{min}^1$ <input type="checkbox"/> Free-progr. relay function 4 terminal A41 P-244 $n_{act} < n_x^1$ <input type="checkbox"/> Free-progr. relay function 5 terminal A51 P-245 Mot-Temp¹ <input type="checkbox"/> Free-progr. relay function 6 terminal A61 P-246 var. relay unctn (P-186)¹ <input type="checkbox"/> Ready/fault terminal 672/674 P-053 ready <p>The segment is energized, if the appropriate relay has pulled-in</p>	<ul style="list-style-type: none"> <input type="checkbox"/> Drive not enabled: progress condition, refer to column "Equip.status" <input type="checkbox"/> Closed-loop speed controlled operation <input type="checkbox"/> Open-loop torque controlled operation <input type="checkbox"/> Torque-controlled operation with slip monitoring <input type="checkbox"/> ModeM19 <input type="checkbox"/> Mode, spindle positioning <input type="checkbox"/> Mode,C axis <input type="checkbox"/> Mode, HPC axis 0.5 ms or 0.3ms <input type="checkbox"/> Mode, HPC axis 0.6 ms or 0.35ms <input type="checkbox"/> Diagnostic function I/f open-loop ctrl. operation <input type="checkbox"/> Oscillation function is selected (fr. Fct. 3.00) 	<ul style="list-style-type: none"> <input type="checkbox"/> NE module pulse enable missing (term.63/term.48) <input type="checkbox"/> Axis-specific pulse enable missing (term.663) <input type="checkbox"/> NE module controller enable missing (term.64) and/or HS module controller enable missing (term.65) <input type="checkbox"/> RFG enable missing (term.81) <input type="checkbox"/> Setpoint enable missing (select terminal Fct. No. 16) <input type="checkbox"/> The torque direction for an enabled motor is displayed: <input type="checkbox"/> Motoring <input type="checkbox"/> Generating <input type="checkbox"/> Speed controller clock cycle fast, clock cycle is active 	<p>Display in P-000: (only for star/delta mode)</p> <ul style="list-style-type: none"> <input type="checkbox"/> Star configuration selected <input type="checkbox"/> Delta configuration selected <input type="checkbox"/> Digital filter is inactive <p>Display in P-100: (only for the spindle positioning mode)</p> <ul style="list-style-type: none"> <input type="checkbox"/> Position 1 is selected <input type="checkbox"/> Position 2 is selected <input type="checkbox"/> Position 3 is selected <input type="checkbox"/> Position 4 is selected <input type="checkbox"/> Incremental positioning is selected 	<ul style="list-style-type: none"> <input type="checkbox"/> Gearbox stage 1 selected <input type="checkbox"/> Gearbox stage 2 selected <input type="checkbox"/> Gearbox stage 3 selected <input type="checkbox"/> Gearbox stage 4 selected <input type="checkbox"/> Gearbox stage 5 selected <input type="checkbox"/> Gearbox stage 6 selected <input type="checkbox"/> Gearbox stage 7 selected <input type="checkbox"/> Gearbox stage 8 selected Gearbox stage 1...8 selected via free-programmable terminal function P-081...P-089 =9, 10, 11

HS

1) As supplied

2.2.2 Firmware version and module version

Table 2-11 Firmware version and module version

Parameter attributes				Setting range	Description
Number		Change effective	P-051		
Mot. 1	Mot. 2				
(P-099)	–	–	–	0.00...99.00	Firmware release
(P-150)	–	–	–	–	Module ID  Function of connector X432: F00H No function 200H With additional input for spindle encoder 300H Output, pulse encoder signals for external use

2.2.3 Setting parameters for standard applications

Overview

- Speed setting values
- Torque limit values
- Motor temperature monitoring
- Oscillation operation

Speed setting values

Table 2-12 Speed setting values

Parameter attributes				Setting range	Description
Number Mot. 1	Number Mot. 2	Change effective	P-051		
P-022	P-261	Online	4	1... n_{rated} RPM	Shutdown speed, pulse cancellation The drive is switched into a no-current condition when the controller is inhibited and the shutdown speed is fallen below (shutdown so that the drive cannot reverse).
P-025		Online	4	0...15000 ms	Time-delayed pulse cancellation after controller inhibit FW 3.00 Pulse cancellation can be delayed after the controller inhibit after braking along the down ramp using P025.
P-029	P-264	Online	4	0... n_{maxMot} RPM	Speed limiting Sets the maximum motor speed
P-036	–	Online	4	– 400...400 dec	Encoder phase error correction If the two encoder tracks don't have a precise 90° offset to one another, this results in a torque ripple. Setting resolution 1 corresponds to 0.18° ⁴ max. value 400, corresponds to 72° ⁴
P-037	P-267	Online	4	1...32000 RPM	Changeover speed, motor encoder evaluation Above this speed, the fine resolution of the speed actual value generation is disabled. (this is no longer relevant from firmware V2.00)
P-038	P-268	Online	4	1...500 RPM	Hysteresis P-037/P-267 (this is no longer relevant from firmware V2.00)

HS

Torque limit values

Table 2-13 Torque limit values

Parameter attributes			P-051	Setting range	Description
Number Mot. 1	Number Mot. 2	Change effective			
P-039.1	P-269.1	Online	4	5...300 %	1st torque limit value (referred to the rated motor torque)
P-041	P-271	Online	4	5...100 %	2nd torque limit value referred to P-039/P-269 This is selected using function No. 1 and it becomes active after the speed, set in P-050/P-290 has been exceeded.
P-050	P-290	Online	4	0...n _{maxMot} RPM	Changeover speed from Md1 to Md2
P-040.1	P-270.1	Online	4	5...100 %	Regenerative limiting (referred to P-039/P-269 or P-041/P-271)
P-042	P-272	Online	4	1...n _{maxMot} RPM	Changeover speed for P-040/P-270
P-043	P-273	Online	4	0...n _{maxMot} RPM	Hysteresis P-042/P-272

Torque [%]
(referred to the rated motor torque)

Speed [RPM]

Max. selectable torque limit:

$$\sqrt{\frac{I_{\max\text{conv}}^2 - I_{0\text{mot}}^2}{I_{\text{ratedmot}}^2 - I_{0\text{mot}}^2}} \cdot 100 \% \quad (\text{referred to } 10 \text{ s overload})$$

$I_{\max\text{conv}}$ – max. drive converter current
 $I_{0\text{mot}}$ – no-load motor current
 I_{ratedmot} – rated motor current

Motor temperature monitoring

Table 2-14 Motor temperature monitoring

Parameter attributes				P-051	Setting range	Description
Number		Change effective	Mot. 1			
P-063	P-291			Online	4	0...170 °C
P-064	–	Online	4	0...170 °C	Fixed temperature For a value $\neq 0$, the motor parameter is calculated using this fixed temperature. Caution! The motor temperature monitoring function is de-activated.	
P-065	–	Online	4	0...600 s	Timer, motor temperature monitoring	

Oscillation mode

Table 2-15 Oscillation mode

Parameter attributes				P-051	Setting range	Description
Number		Change effective	Mot. 1			
P-154	–			Online	4	$-\dot{n}_{\max\text{mot}} \dots n_{\max\text{mot}}$ RPM
P-155	–	Online	4	$-\dot{n}_{\max\text{mot}} \dots n_{\max\text{mot}}$ RPM	Oscillation setpoint 2	
P-156	–	Online	4	10...10000 ms	Oscillation interval time 1	
P-157	–	Online	4	10...10000 ms 0...10000 ms from FW 3.00	Oscillation interval time 2 From FW 3.00, when entering a 0, only the value in P154 becomes effective	

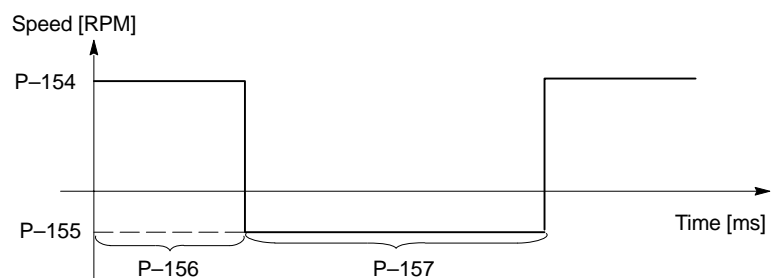

2.3 Additional applications

2.3.1 Orientated spindle stop (using NC auxiliary function M19)

Function M19 can be switched-in using a select terminal (E1 to E9) (refer to Section 3.2.2).

Table 2-16 Orientated spindle stop (using NC auxiliary function M19)

Parameter attributes				P-051	Setting range	Description
Number		Change effective	Mot. 1			
P-054	–			Online	4	$-\dot{n}_{\max\text{mot}} \dots \dot{n}_{\max\text{mot}}$ RPM
P-055	–	Online	4	C000...4000 hex	M19 offset correction e. g. positive corrective value 2FH negative corrective value FF00H	
P-056	–	Online	4	$0 \dots \dot{n}_{\max\text{mot}}$ RPM	M19 changeover speed Speed changeover point of the setpoint normalization factor. When the selected speed is fallen below, the values, entered in parameters P-054 and P-055 become effective.	
P-058	–	Online	4	$0 \dots \dot{n}_{\max\text{mot}}$ RPM	Shutdown threshold, rounding-off M19 When the selected speed is fallen below, the speed setpoint smoothing and rounding-off are disabled. They can only be re-enabled after first canceling M19 mode. FW 2.00	
P-062	–	Online	4	$0 \dots \dot{n}_{\max\text{mot}}$ RPM	M19 switching threshold, I component, speed controller Speed actual value threshold for switching-in the speed controller integral action time. The integral action time is switched-in again when the absolute value falls below the speed entered in P-062.	
P-090	–	Online	10	0...FFFF hex	Control word P-062 is activated by setting bit 4 = 1 (corresponds to 10H) in P-090.	

2.3.2 C axis

C-axis operation can be selected using a select terminal (E1 to E9) (Section 3.2.2). The setpoint can only be entered via terminals 24 and 8.

Table 2-17 C axis

Parameter attributes			P-051	Setting range	Description
Number	Change effective				
Mot. 1	Mot. 2				
P-114.1	–	Online	4	$-n_{\text{rated}}-1 \dots n_{\text{rated}}-1$ RPM	Normalization, speed setpoint C axis Speed, which is reached with the analog input voltage in P-024. + = cw direction of rotation for a positive speed setpoint – = ccw direction of rotation for a positive speed setpoint
P-115.1	–	Online	4	C000...4000 hex	Offset correction to P-114 Max. corrective value 2000 or E000 corresponds approx. 1/8 of P-114, if P-024 = 10.0

HS

2.3.3 Spindle positioning

Overview

- Function description
- Position reference values
- Function parameter 1
- Position controller
- Control parameter
- Function parameter 2
- Diagnostics parameter
- Brief start-up

Function description

The main spindle is positioned from the same direction of rotation or with direction of rotation reversal without a higher-level position control loop of a numerical control.

There are various ways of sensing the position:

- With motor encoder (sin/cos tracks) without gearbox ratio (all of the parameters are pre-initialized for this particular case)
- With motor encoder (sin/cos tracks) and external zero mark (BERO) at the spindle for gearbox stage changeover
- With incremental spindle encoders (max. 8192 pulses per revolution), only for versions with input for a spindle encoder (6SN11□□-□BA12-0□A0)

Spindle encoder signals are always processed with squarewave evaluation including pulse quadrupling.



Warning

A spindle encoder may not be connected to MSD control boards with pulse encoder signal output for external use (Order No. [MLFB] 6SN11□□-□BA13-0□A0)! If this is not observed, the unit and spindle encoder could be damaged.

The hardware configuration must be entered via **P-141**.

The select terminal function "Positioning On" (funct. No. 28) must be connected to one of the freely-programmable terminals E1 to E9 via parameters **P-081** to **P-089** (refer to Section 3.2.2). Positioning is initiated by connecting the enable voltage to the selected terminal.

Positioning is executed in several phases:

- **The drive is braked**

Starting from any speed, the drive brakes along the characteristic, specified by the ramp-up/ramp-down generator, down to the search speed. The speed setpoint is specified by the open-loop positioning control; a speed setpoint, possibly available at terminal 56, is suppressed.

The search speed is the highest speed from which the drive can brake in one revolution down to the target position without overshoot. The search speed is limited towards the top by the deceleration capacity of the drive and therefore the external moment of inertia.

- **Position is sensed**

The position controller is switched-in after the search speed has been reached and the zero mark has been recognized.

- **Move to the position**

The last revolution before the target is sub-divided into three phases, depending on the distance to the target.

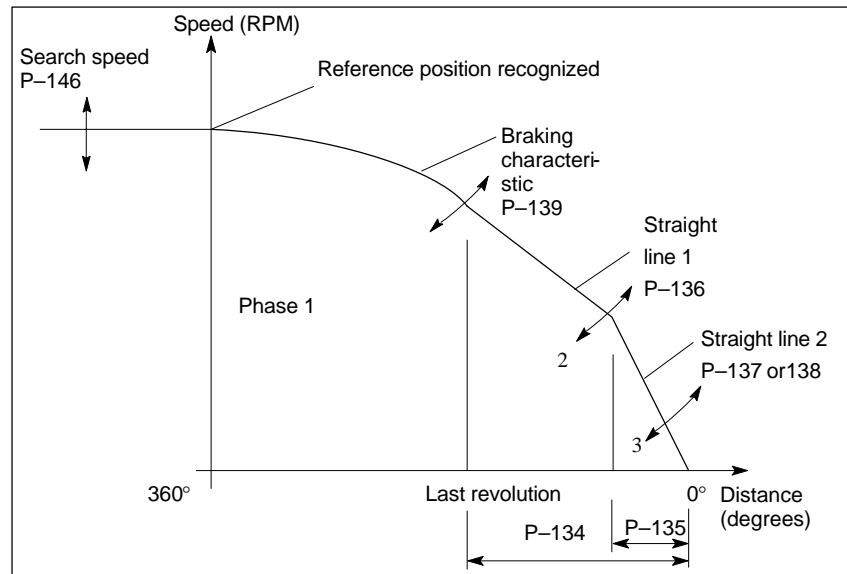

Fig. 2-1 Moving into position

The starting points of the various phases and the gradients of the individual sections can be set. This means that the approach characteristics can be adapted to the widest range of requirements (**P-134 to P-139**).

If the drive moves at a speed less than the search speed, then the drive can accelerate to the search speed to shorten positioning (**P-142**).

For most applications, it is sufficient to optimize the system by adapting the search speed **P-146** and adapting parameters **P-137 or P-138**.

- **Reference value format**

The position reference value may only have values from 0 to max. +32767, from firmware release V2.00, max. 64000 l/rev (this corresponds to the max. encoder pulse number between two zero pulses). The direction of rotation is obtained from the polarity of the search speed. Position reference values are entered in encoder pulses.

When positioning with the motor encoder, **P-141** allows a multiplication factor to be entered to improve the setpoint resolution. Values of 1, 2, 4, 8, 16 and 32 can be entered. The multiplication factor can be selected so high, that a computed pulse number of up to 32768 can be obtained.

Example:

The standard RON350 encoder (2048 pulses). When using a multiplication factor of 16, this results in a computed pulse number of 32768. This value should then be entered into **P-131**. Setpoint inputs of between 0 and 32768 can be entered; from firmware release V2.00, max. 64000 l/rev. If higher values are entered, fault message FP-01 is output when positioning.

2.3 Additional applications

- **Position reference value is entered**

The drive can be positioned using four internal position reference values per gearbox stage (**P–121 to P–122** and **P–124 to P–125**).

Select terminal function 23	Select terminal function 27	Position reference value	Parameters for the position reference value
0	0	1	P–121
1	0	2	P–122
0	1	3	P–124
1	1	4	P–125

After the reference position has been reached, another setpoint can be activated using select terminal functions 23 and 27. In this case, the signal must change at both terminals within 20 ms, so that they are identified as being simultaneous.

A new position is only selected using a gearbox stage terminal when in the “In position” status, only if the signal changes from a low to a high at the terminal with function 28 (positioning “On”). Contrary to select terminal functions 23 and 27, in this case, the zero mark is always passed again.

- **Incremental position reference value**

An incremental position reference value for each gearbox stage can be entered via parameter **P–123**. If the spindle is in position, and a positive edge appears at the freely-programmable terminal, assigned with select function 22, then the incremental position reference value is added to the actual position reference value and the drive moves to the calculated new position. This operation can be re-initiated after the new position has been reached.

Negative values are permissible for parameters **P–123**, contrary to **P–121**, **P–122**, **P–124** and **P–125**.

- **Zero offset**

A zero offset can be entered via parameters **P–129/P–130**.

Setting possibility:

Select the positioning control (open-loop) (**P–149 = 1H**) inhibit the controller and pulses.

Rotate the spindle through a complete revolution, and then bring to the required position (check using **P–140** corresponds to the position actual value). Set **P–129** to 1H and wait until the parameter automatically writes back 0H to itself. The actual position is then transferred as the new zero mark. The difference to the actual zero mark is displayed in **P–130**. If the system now positions to 0H, the spindle moves to the position which has been saved in **P–130**.

- **Relay signals**

Select relay functions 9 and 10 (refer to Section 3.3.2) are available for the relay messages “Position reached”. The associated tolerances are entered via parameters **P–144** and **P–145**.

- **Re-synchronizing the spindle (zero mark)**

The position counter status of the spindle is re-synchronized after each gearbox stage change when a BERO zero mark is used. This re-synchronization routine can be suppressed, or specifically selected via select terminals.

Setting possibility:

Spindle re-synchronization after a gearbox stage change can be suppressed by setting bit 1 in parameter **P-149**. A signal change at a freely-programmable terminal, assigned the select terminal function "Gearbox stage, bit 0 to bit 2" is interpreted by the position controller as parameter changeover. If the gearbox is mechanically changed-over, then when positioning using a motor encoder with external zero mark, this must be signaled to the position controller via select terminal function 29.

The select terminal function 29 latches (the state is saved). The high signal level must be present for at least 20 ms.

Position reference values

Table 2-18 Position reference values

Parameter attributes			P-051	Setting range	Description
Number Mot. 1	Mot. 2	Change effective			
P-121	–	Online	4	0...64000 dec	Position reference value 1 The value is entered as encoder pulse number (max. entry is increments per revolution)
P-122	–	Online	4	0...64000 dec	Position reference value 2
P-123	–	Online	4	–32768...32767 dec	Position reference value, incremental The value is entered as encoder pulse number (max. entry is increments per revolution)
P-124	–	Online	4	0...64000 dec	Position reference value 3
P-125	–	Online	4	0...64000 dec	Position reference value 4

2.3 Additional applications

Function
parameter 1

Table 2-19 Function parameter 1

Parameter attributes				P-051	Setting range	Description
Number		Change effective	Mot. 1			
Mot. 1	Mot. 2					
P-126	–	Online	4	0.0...180 degrees	Bandwidth integrator enable, speed controller In order to improve the approach characteristics when positioning, it can be sometimes advantageous if the speed controller integrator is disabled. In the target range, the integrator inhibit is removed again (I component = 0). The bandwidth of the target range can be selected using this parameter.	
P-149	–	Online	4	0...FFFF hex	Start-up parameter, C axis/position. The integrator inhibit function is enabled by setting bit 5 (20H) via P-149.	
P-129	–	Online	4	0...1 hex	Setting the internal zero The zero offset to the hardware zero is entered into P-130 by setting bit 0 (1H) (actual position counter status).	
P-130	–	Online	4	0...64000 dec	Zero offset Enters the difference to the hardware zero	
P-131	–	Online	4	128...64000 dec	Max. pulse number between 2 zeros Enters the pulse number for one spindle revolution. If a spindle encoder (squarewave signals) is used, then pulse quadrupling can be taken into account. If the system positions using a gearbox and BERO, the difference between two consecutive BERO zero marks can be read via P-133. P-133 indicates the most accurate results in the speed range between 100 and 500 RPM. Data read at standstill provide incorrect values.	

Position controller

Table 2-20 Position controller

Parameter attributes			P-051	Setting range	Description
Number Mot. 1	Mot. 2	Change effective			
P-134	–	Online	4	0.0...180.0 degrees	Intervention point P-136
P-135	–	Online	4	0.0...180.0 degrees	Intervention point P-137/P-138
P-136	–	Online	4	0...FFFF hex	P gain, straight line 1
P-137	–	Online	4	0...FFFF hex	P gain, straight line 2 Gain setting when positioning with spindle encoder
P-138	–	Online	4	0...FFFF hex	P gain, straight line 2 (HMS) Gain setting when positioning with motor encoder.
P-139	–	Online	4	0...FFFF hex	Multiplication factor for braking parabola Factor to adjust the gradient of the braking characteristic, refer to Fig. 2-1.

2.3 Additional applications

Control parameters

Table 2-21 Control parameters

Parameter attributes			P-051	Setting range	Description																											
Number	Change effective																															
Mot. 1	Mot. 2																															
P-141	–	Online via P-143	4	0...FFFF hex	Switching parameter, positioning																											
					<table border="1"> <thead> <tr> <th>Bit</th> <th>Value</th> <th></th> </tr> </thead> <tbody> <tr> <td>0</td> <td>0000H 0001H</td> <td>Evaluates the motor encoder signals (HMS evaluation) Evaluates the spindle encoder signal Note: X432 must be configured as spindle encoder input. This is only possible for module versions 6SN1121-0BA12-0AA0 (always) and 6SN1121-0BA11-0AA1 (using P033=0). If this is not done, fault message F-10 will be output. Spindle encoder signals are always evaluated as squarewave signals including pulse quadrupling.</td> </tr> <tr> <td>1</td> <td>0000H 0002H</td> <td>Zero pulse from an encoder External zero pulse (e. g. BERO)</td> </tr> <tr> <td>2</td> <td>0000H 0004H</td> <td>Spindle encoder phase sequence is not inverted Spindle encoder phase sequence is inverted (actual value reversal)</td> </tr> <tr> <td>8</td> <td>0100H</td> <td>Setpoint multiplication factor 2 for positioning with a motor encoder with internal zero.</td> </tr> <tr> <td>9</td> <td>0200H</td> <td>Setpoint multiplication factor 4 for positioning with a motor encoder with internal zero.</td> </tr> <tr> <td>10</td> <td>0400H</td> <td>Setpoint multiplication factor 8 for positioning with a motor encoder with internal zero.</td> </tr> <tr> <td>11</td> <td>0800H</td> <td>Setpoint multiplication factor 16 for positioning with a motor encoder with internal zero.</td> </tr> <tr> <td>12</td> <td>1000H</td> <td>Setpoint multiplication factor 32 for positioning with a motor encoder with internal zero.</td> </tr> </tbody> </table>	Bit	Value		0	0000H 0001H	Evaluates the motor encoder signals (HMS evaluation) Evaluates the spindle encoder signal Note: X432 must be configured as spindle encoder input. This is only possible for module versions 6SN1121-0BA12-0AA0 (always) and 6SN1121-0BA11-0AA1 (using P033=0). If this is not done, fault message F-10 will be output. Spindle encoder signals are always evaluated as squarewave signals including pulse quadrupling.	1	0000H 0002H	Zero pulse from an encoder External zero pulse (e. g. BERO)	2	0000H 0004H	Spindle encoder phase sequence is not inverted Spindle encoder phase sequence is inverted (actual value reversal)	8	0100H	Setpoint multiplication factor 2 for positioning with a motor encoder with internal zero.	9	0200H	Setpoint multiplication factor 4 for positioning with a motor encoder with internal zero.	10	0400H	Setpoint multiplication factor 8 for positioning with a motor encoder with internal zero.	11	0800H	Setpoint multiplication factor 16 for positioning with a motor encoder with internal zero.	12	1000H	Setpoint multiplication factor 32 for positioning with a motor encoder with internal zero.
Bit	Value																															
0	0000H 0001H	Evaluates the motor encoder signals (HMS evaluation) Evaluates the spindle encoder signal Note: X432 must be configured as spindle encoder input. This is only possible for module versions 6SN1121-0BA12-0AA0 (always) and 6SN1121-0BA11-0AA1 (using P033=0). If this is not done, fault message F-10 will be output. Spindle encoder signals are always evaluated as squarewave signals including pulse quadrupling.																														
1	0000H 0002H	Zero pulse from an encoder External zero pulse (e. g. BERO)																														
2	0000H 0004H	Spindle encoder phase sequence is not inverted Spindle encoder phase sequence is inverted (actual value reversal)																														
8	0100H	Setpoint multiplication factor 2 for positioning with a motor encoder with internal zero.																														
9	0200H	Setpoint multiplication factor 4 for positioning with a motor encoder with internal zero.																														
10	0400H	Setpoint multiplication factor 8 for positioning with a motor encoder with internal zero.																														
11	0800H	Setpoint multiplication factor 16 for positioning with a motor encoder with internal zero.																														
12	1000H	Setpoint multiplication factor 32 for positioning with a motor encoder with internal zero.																														
					<p>Note: When changing the setpoint multiplication factor (bits 8 to 12), before accepting the new setting, the pulse number must be adapted in P-131 using P-143. The modified settings must be activated using P-143. The setting of parameter P-141 is accepted and activated by writing a 1 into parameter P-143 instead of 0!</p>																											

Table 2-21 Control parameters

Parameter attributes				Setting range	Description		
Number		Change effective	P-051				
Mot. 1	Mot. 2					Bit	Value
P-142	–	Online	4	0...21 hex	Speed increase flag		
					0	0000H	The drive first accelerates to the search speed if positioning is started from a speed which is lower than the search speed and then the position is approached (faster positioning). The drive does not accelerate to the search speed and the drive moves into the position from the present speed.
						0001H	
5	0000H	Zero mark monitoring (fault FP-02) has been enabled. When positioning with a BERO, the zero mark is evaluated for each positioning operation, otherwise, only after gearbox stage changeovers. The zero mark monitoring is also inhibited after a gearbox stage changeover, if P-142, bit 0 is set to 1.					
	0020H	Zero mark monitoring (fault FP-02) is inhibited.					
P-143	–	Online	4	0...1 hex	Transfer parameter P-141 Modified values are transferred into P-141, if P-143 = 1. The parameter is automatically reset to 0.		

Function parameter 2

Table 2-22 Function parameter 2

Parameter attributes			P-051	Setting range	Description
Number Mot. 1	Mot. 2	Change effective			
P-144	–	Online	4	0.00...18.00 de- grees	Response width, relay 1 Setting value for "In position 1" relay signal (refer to Section 3.3.2)
P-145	–	Online	4	0.00...18.00 de- grees	Response width, relay 2
P-146	–	Online	4	0...4 · n _{rated}	Search speed Speed setting value, which is started when entering the position.
P-148	–	Online	4	0.0...180.0 degrees	Motion window If the spindle is pushed out of its position with the pulses inhibited in the positioning mode, then when the pulses are re-enabled, the reference position is re-approached along the shortest distance. If bit 3 is set in P-149, this is only realized, if the motion window (P-148) is not exited and the terminal with funct. No. 28 (high) was not switched.

Tabelle 2-22 Function parameter 2

Parameter attributes				Setting range	Description	
Number		Change effective	P-051			
Mot. 1	Mot. 2					
P-149	–	Online	4	0...FFFF hex	Commissioning parameters, C axis/position	
					Bit Value	
					0 0000H 0001H	Positioning inhibited, the control for the positioning is not processed, i. e. positioning is not possible and possible position actual value displays are not precise! The control for positioning is processed and positioning is possible.
					1 0000H 0002H	When a positioning command is received (terminal with funct. No. 28 high), the spindle is re-synchronized, if, beforehand, the signal changes at one freely programmable terminal assigned the select terminal function "Gearbox stage bit 0 to bit 2". The spindle is only re-synchronized, if, before the positioning command, there was a positive signal edge at a select terminal assigned function 29.
					2 0000H 0004H	The position reference values are not mirrored. The position reference values are mirrored.
					3 0000H 0008H	The position is always approached from the same direction of rotation; the direction of rotation is entered using the sign (polarity) of the search speed. (exception, refer to P-148)
					5 0000H 0020H	The speed controller integral action time is active. The speed controller integral action is disabled. The integral action time is re-activated in the target range (can be set using P-126).
					6 0040H	Reduction of overshoots after braking down to the search speed FW 2.00
					7 0000H 0080H	The speed setpoint rounding-off (P-019) is also effective while positioning. The speed setpoint rounding-off (P-019) is de-activated when the positioning command is received. The speed setpoint smoothing (P-018) is never effective during a positioning operation, independent of P-149.

2.3 Additional applications

Diagnostic parameters

Table 2-23 Diagnostic parameters

Parameter attributes				Setting range	Description
Number Mot. 1	Number Mot. 2	Change effective	P-051		
(P-100)	–	–	–	–	Operating display P-100 (refer to Section 2.2.1)
(P-128)	–	–	–	–	Actual position reference value The actual reference position is displayed in parameter P-128 in the form of encoder pulses. However, the value is only updated, if the positioning software is enabled by P-149 = 1.
(P-132)	–	–	–	–	Absolute position actual value without zero offset
(P-133)	–	–	–	–	Difference between 2 ext. zero marks The difference between two consecutive BERO zero marks is displayed (P-141 = 2).
(P-140)	–	–	–	–	Absolute position actual value with zero mark offset
(P-147)	–	–	–	–	Position counter status with respect to BERO The position counter status is displayed when positioning with BERO.
(P-320)	–	–	–	–	Diagnostics, motor encoder zero mark
(P-321)	–	–	–	–	Diagnostics, spindle encoder zero mark

**Brief
commissioning****Commissioning example**

Hardware structure: Encoder signals and zero pulse from the motor encoder

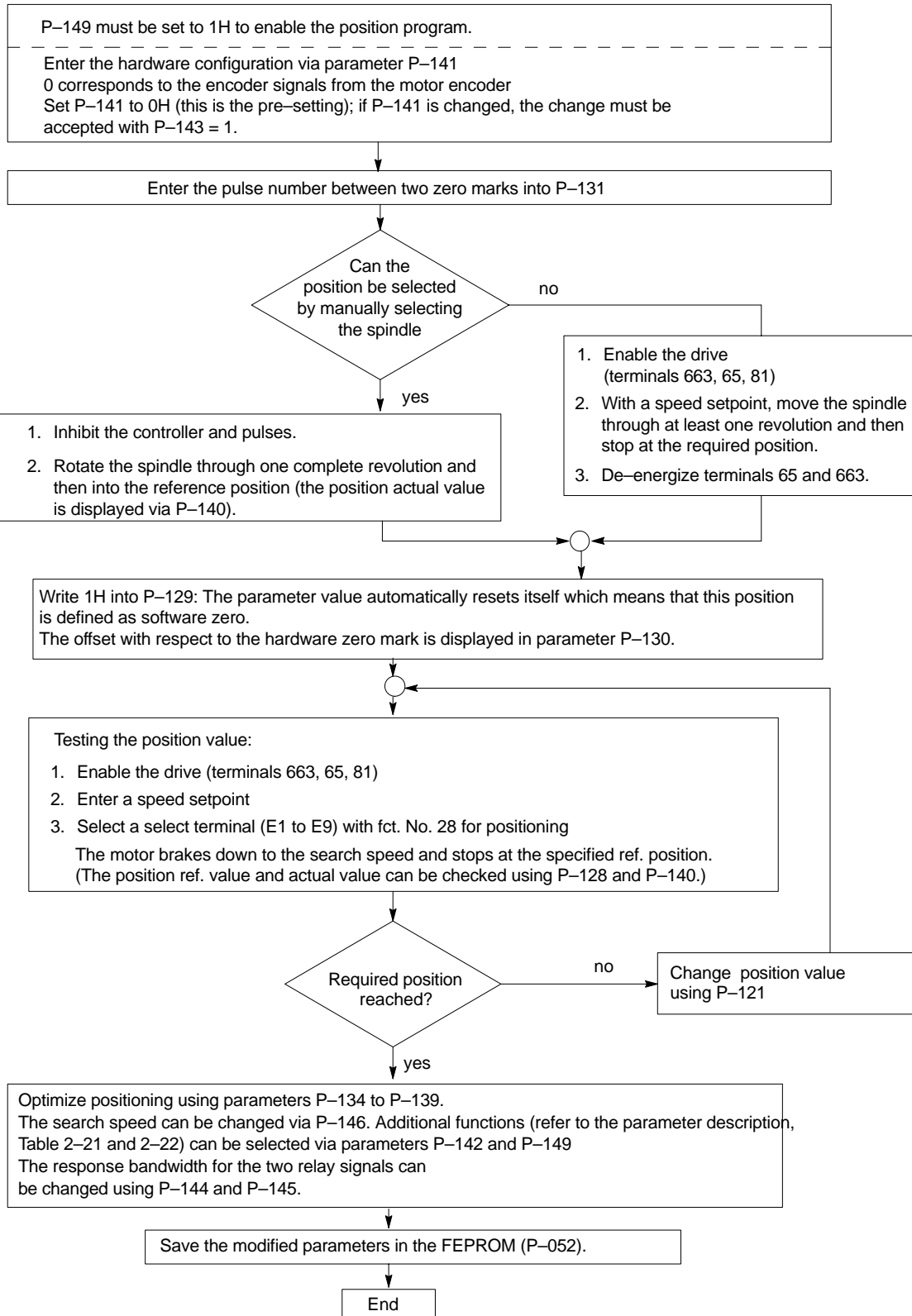

HS

2.3.4 Open-loop torque controlled mode (master/slave)

Overview

- Function description
- Parameter settings
- Parameter description
- Slip monitoring

Function description

Open-loop torque controlled operation is necessary if the speed controller is used in the NC or for the slave drive for master/slave applications. Open-loop torque controlled operation can be selected via select terminal E1 to E9 (refer to Section 3.2.2). For master/slave operation (2 spindle drives can be operated, rigidly coupled together), the torque setpoint must be fed to the slave drive from the master via a D/A converter output (adaptation **P-066** or **P-068**, refer to Section 3.3.5) (adaptation **P-048**, **P-049**).



Warning

If the mechanically rigid coupling is released, the slave drive must be changed-over to "Closed-loop speed control", otherwise the drive would accelerate to max. speed, even for an M_d setpoint input of 0.

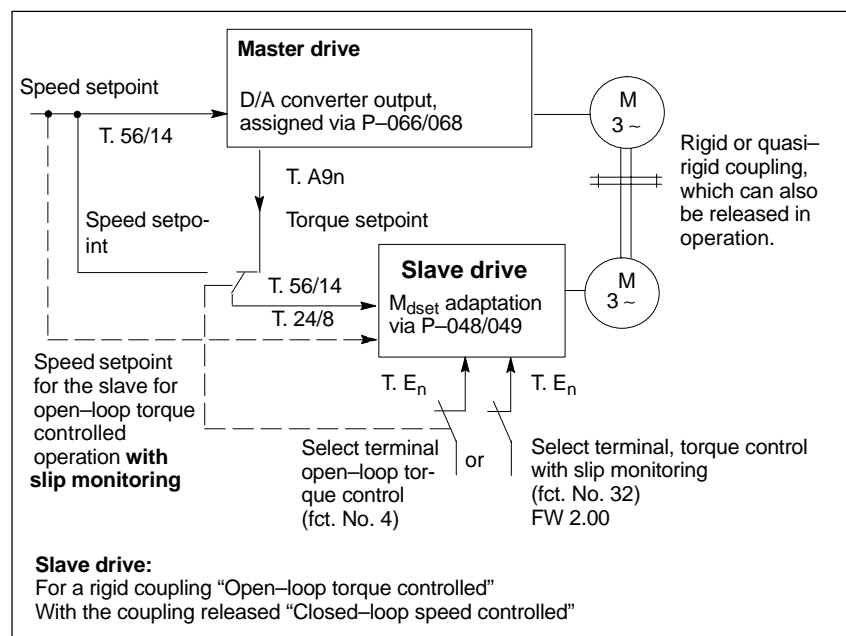

Fig. 2-2 Master/slave operation

Note

When the controller is inhibited in the open-loop torque controlled mode, the drive must be braked via the M_d setpoint input; the pulses are only internally canceled after the shutdown speed has been reached (**P-022**).

Parameter settings

Example:

In order that the torque setpoint is available at terminals A92 and M of the master drive, address 0C6CH must be written into parameter **P-068**. Using parameter **P-069**, by shifting, it is possible to determine which voltage is available at a specific torque.

The normalization of the rated motor torque can be taken from the contents of address 0F52H. In order to determine this value, address 0F52H must be entered into **P-250**, and the normalization value for the rated torque can be read-out of **P-251**.

Contents P-251 (hex)	Shift factor P-069	Value to be converted (hex)	Output voltage D/A conv. 2 [V] at $M_{d\text{rated}}$
0C00	0	0C00	0.94
	1	1800	1.88
	2	3000	3.75
	3	6000	7.50
1000	0	1000	1.25
	1	2000	2.50
	2	4000	5.00

At the max. output voltage, the torque limit in **P-039** must be taken into account (160 % corresponds to $M_{d\text{rated}} \cdot 1.6$), and it must be guaranteed that there is no overcontrol (> 10 V).

If the slave drive is switched into the torque mode, parameters **P-048** and **P-049** still remain effective. The torque can be changed using **P-048** (this corresponds to **P-014** in the closed-loop speed controlled mode) and the torque drift can be compensated using **P-049** (corresponds to **P-015** in the closed-loop speed controlled mode). Parameter **P-049** is not suitable to compensate frictional forces. **P-048** and **P-049** are not effective in closed-loop speed controlled operation.

The following is valid from FW 3.00:

The torque data is updated via address 304C with 1 ms (previously 20 ms), and is normalized with $5 \text{ V} \hat{=} \text{rated motor torque}$.

Example:

Output via terminals A92 and M

P68 = 304CH, P69 = 0H

The normalization can be influenced by P26.

For P26 = 100 %, 5 V corresponds to the rated torque.

For P26 = 160 %, 8 V corresponds to the rated torque.

Parameter description

Table 2-24 Parameter description

Parameter attributes			P-051	Setting range	Description
Number Mot. 1	Mot. 2	Change effective			
P-048	–	Online	4	–250...250 %	Normalization M_{dset} The setting value is referred to the rated motor torque.
P-049	–	Online	4	C000...4000 hex	Offset, torque setpoint

Open-loop torque control with slip monitoring FW 2.00

The mechanical coupling of drives using a friction-locked connection can result in slip for open-loop torque controlled slave drives.

With this function, the slave drive monitors the deviation between the speed actual value and the speed setpoint and reduces the drive torque when a speed tolerance is exceeded.

Assignment, speed setpoint channels:

- Master drive, terminal 56/14
- Slave drive, terminal 24/8

The open-loop torque control with slip monitoring can be activated using select terminal function No. 32 (refer to Fig. 2-2).

Table 2-25 Slip monitoring

Parameter attributes			P-051	Setting range	Description
Number	Change effective				
Mot. 1	Mot. 2				
P-340	–	Online	4	0.1...100.0 %	Speed deviation, slip monitoring Permissible speed deviation referred to the actual speed setpoint.
P-346	–	Online	4	0.0...100.0 %	Hysteresis, P-340
P-341	–	Online	4	0.0...100.0 %	Torque reduction, slip monitoring If the speed deviation, parameterized in P-340 is exceeded, the torque setpoint is reduced.
P-343	–	Online	4	0...999 ms	Delay time, slip monitoring Delay time until the torque reduction is removed.
P-344	–	Online	4	0.01...100.0 %/ms	Torque red. rate of change, slip monitoring Rate at which the torque setpoint is reduced.
P-345	–	Online	4	0.01...100.00 %/ms	Rate of increase of the slip monitoring Rate at which the torque setpoint is increased.
(P-347)	–	Online	–	–	Speed dev. actual slip monitoring If the displayed value is greater than the threshold, set in P-340, then slip occurs, and the monitoring is activated.

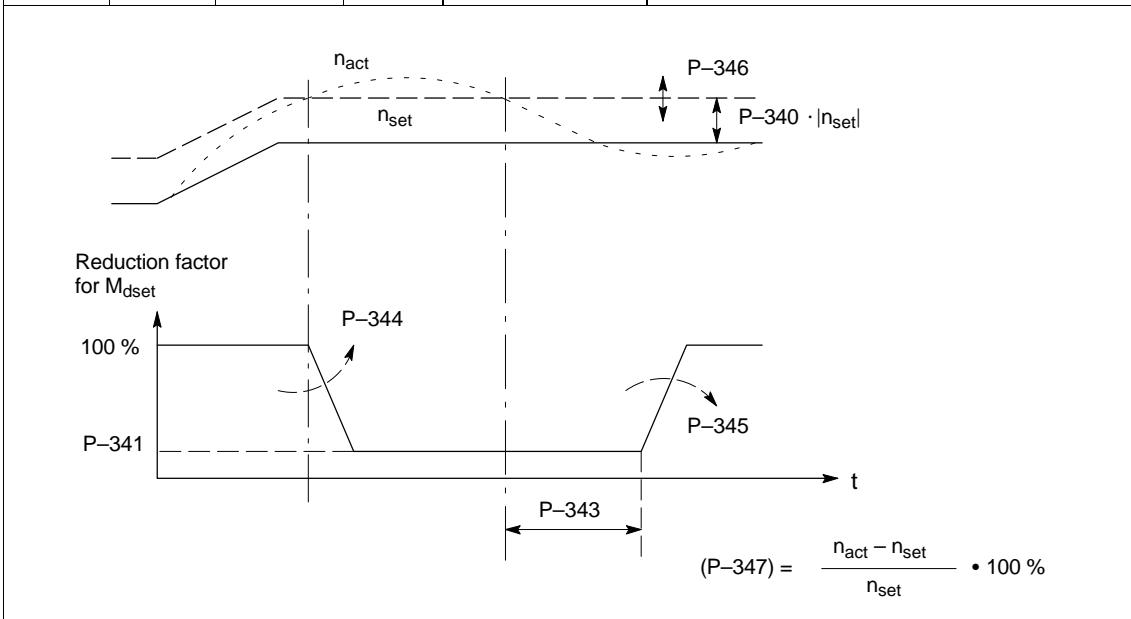

HS

2.3.5 Monitor function

The address contents (data in the RAM area) of the MSD module can be read using parameters **P–249** to **P–251**.

Note

There is a list of important measured quantities (RAM variables) and their addresses in the Attachment (Section 6.5).

Table 2-26 Monitor function

Parameter attributes				P–051	Setting range	Description
Number		Change effective	P–051			
Mot. 1	Mot. 2					
P–249	–	Online	10	0...FFFF hex	Segment, memory location monitor Selects the segment address	
P–250	–	Online	10	0...FFFF hex	Address, memory location monitor Selects the offset address	
P–251	–	Online	–	–	Value display, memory location monitor Displays the contents of address P–249/P–250	

2.3.6 HPC axis (FW 2.00)

Only the freely-programmable terminals E1 to E6 can be assigned functions in the HPC-axis mode.

Overview

- Function description
- System configuration
- Drive converter interfaces
- Controller optimization
- Diagnostics

Function description

The **High Precision C** axis mode (HPC) can achieve improved load and control characteristics by reducing the speed controller clock cycle to 0.5 or 0.6 ms. From FW 3.00, 0.3 or 0.35 ms are possible.

Expanded functionality in the HPC-axis mode:

- Flux adaptation (noise reduction)
- 2 digital filters can be parameterized in the torque setpoint channel for a 0.6 ms speed controller clock cycle (from FW 3.00, 0.35 ms is possible).

The following functions are not available in the HPC-axis mode:

- Torque setpoint smoothing
- Oscillation
- NC auxiliary function M19
- 2nd torque limit value
- Ramp-function generator
- Speed controller adaptation
- Gearbox stage changeover
- Spindle positioning
- Reduced terminal and relay functions
- Smoothing, D/A converter P/P_{max} display

System configuration

Prerequisites for HPC axis operation:

- Speed range: $\pm n_{ratedmotor}$
- Can only be selected for motor 1 (star operation)
- HPC axis has priority over a standard C axis
- Changeover in the normal mode is realized online; then, all of the functions are available again.

- **Selecting an HPC axis**

Table 2-27 Selecting an HPC axis

Parameter attributes				Setting range	Description						
Number Mot. 1	Number Mot. 2	Change effective	P-051								
P-149	–	Online	4	0...FFFF hex	Commissioning parameters, C axis/position						
					<table border="1"> <thead> <tr> <th>Bit</th> <th>Value</th> <th></th> </tr> </thead> <tbody> <tr> <td>8</td> <td>0000H 0100H</td> <td>HPC axis cannot be selected HPC axis can be selected</td> </tr> </tbody> </table>	Bit	Value		8	0000H 0100H	HPC axis cannot be selected HPC axis can be selected
Bit	Value										
8	0000H 0100H	HPC axis cannot be selected HPC axis can be selected									
					The HPC-axis mode is selected using the select terminal function No. 30						

- **Torque limit values**

Table 2-28 Torque limit values

Parameter attributes				Setting range	Description
Number Mot. 1	Number Mot. 2	Change effective	P-051		
P-109	–	Online	4	5...180 %	Torque limit value, HPC Sets the max. permissible torque, referred to the rated motor torque.
P-110	–	Online	4	5...100 %	Regenerative limiting, HPC Limits the torque in regenerative operation, referred to P-109.

2.3 Additional applications

Drive converter interfaces

- **Analog setpoint**

The analog speed setpoint or Md setpoint is only entered via setpoint channel 2 (terminal 24/8).

The speed setpoint is limited to $\pm n_{\text{ratedmotor}}$.

Table 2-29 Analog speed setpoint

Parameter attributes			P-051	Setting range	Description
Number Mot. 1	Mot. 2	Change effective			
P-093	–	Online	4	C000...4000 hex	Offset correction, speed setpoint HPC Drift compensation for the analog speed setpoint input.
P-094	–	Online	4	$-n_{\text{rated}}-1 \dots$ $+n_{\text{rated}}-1$ RPM	Normalization, speed setpoint HPC The speed can be set with P-094, which should be reached, for the analog input voltage, which was set in P-024.

- **Permanently wired terminal functions**

Terminals 663, 65 and 81 are also available in the HPC-axis mode.

- **Freely-programmable terminal functions**

Only input terminals E1 to E6 (P-081 to P-086) are evaluated.

The following terminal functions are available (refer to Section 3.2.2)

Table 2-30 Terminal functions

Terminal function	Function No.
Reset fault memory (R) (fault acknowledgement)	3
Open-loop torque controlled operation	4
Integrator inhibit, speed controller	8
Speed setpoint smoothing	25
Suppress F-11 (traverse to fixed endstop)	26
HPC axis	30
Inverter clock cycle frequency	33 34

- **Permanently-wired relay functions**

Terminals 672/673/674 are also available in the HPC-axis mode.

- **Freely-programmable relay functions**

The statuses of the non-available relay functions are frozen when changing-over into the HPC-axis mode.

The following relay functions are available (refer to Section 3.3.2):

Table 2-31 Relay functions

Terminal function	Function No.
$n_{act} < n_{min}$	1
Motor overtemperature, pre-alarm	5
Drive converter overtemperature, pre-alarm	6
Variable, relay function 1	7
Variable, relay function 2	8

Controller optimization

- **Speed setpoint smoothing**

Table 2-32 Speed setpoint smoothing

Parameter attributes				Setting range	Description		
Number Mot. 1	Number Mot. 2	Change effective	P-051				
P-106	–	Online	4	3...10000 ms	Smoothing time speed setpoint smoothing HPC (Switched-in/out using P-053 or using select terminal function No. 25)		
P-053	–	Online	4	0...FFFF hex	Control word		
					Bit	Value	
					4	0000H 0010H	Speed setpoint smoothing inactive Speed setpoint smoothing active

- **Gain, integral action time, speed controller**

Table 2-33 Gain, integral action time, speed controller

Parameter attributes				Setting range	Description
Number Mot. 1	Number Mot. 2	Change effective	P-051		
P-111	–	Online	4	3.0...240.0 dec	P gain, speed controller HPC The P-gain setting is, with the same gain factor, a factor of 4 smaller with respect to the normal mode.
P-112	–	Online	4	2...6000 ms	Integral action time, speed controller HPC

2.3 Additional applications

- **Flux adaptation**

Table 2-34 Flux adaptation

Parameter attributes			P-051	Setting range	Description
Number Mot. 1	Mot. 2	Change effective			
P-119	–	Online	4	5...100 %	Flux adaptation HPC Reduces the magnetic motor flux (noise reduction)

- **Digital filter, speed setpoint channel**

2 digital filters can be parameterized in the HPC-axis mode, which are then switched in series.

However, the filter can only be activated if the speed controller sampling time is set to 0.6 ms via **P-117**.

The actual sampling time can be recognized in the operating display (Section 2.2.1) (dig. filter, also refer to Section 4.1).

Table 2-35 Digital filter, torque setpoint channel

Parameter attributes			P-051	Setting range	Description		
Number Mot. 1	Mot. 2	Change effective					
P-118	–	Online	4	0...FFFF hex	Torque setpoint filter type		
					Bit	Value	
					0	0000H 0001H	Bandstop characteristics, normal mode Lowpass characteristics, normal mode
					8	0000H 0100H	Bandstop filter 1 HPC-axis mode Lowpass filter 1 HPC-axis mode FW 2.00
9	0000H 0200H	Bandstop filter 2 HPC-axis mode Lowpass filter 2 HPC-axis mode FW 2.00					
P-091	–	Online	4	45...750 Hz	Frequency, filter 1 HPC Lowpass: 3 dB transition frequency Bandstop: Center frequency		
P-092	–	Online	4	0.50...10.00 dec	Quality, filter 1 HPC Filter quality of the bandstop, Quality = 1 corresponds to 1.00		
P-107	–	Online	4	45...750 Hz	Frequency, filter 2 HPC		
P-108	–	Online	4	0.50...10.00 dec	Quality, filter 2 HPC		

Table 2-35 Digital filter, torque setpoint channel

Parameter attributes			P-051	Setting range	Description		
Number	Change effective						
Mot. 1	Mot. 2				Bit	Value	
P-117	–		4	0...FFFF hex	Select, torque setpoint filter		
		Online			0	0000H 0001H	Filter normal mode not active Filter normal mode active
		Online			8	0000H 0100H	Filter 1 HPC-axis mode not active Filter 1 HPC-axis mode active FW 2.00
		Online			9	0000H 0200H	Filter 2 HPC-axis mode not active Filter 2 HPC-axis mode active FW 2.00
		RESET			10	0000H 0400H	Speed controller sampling time 0.5 ms, no filter in the HPC-axis mode possible. From FW 3.00, 0.3 ms. Speed controller sampling time 0.6 ms, filters in the HPC-axis mode can be activated. From FW 3.00, 0.35 ms. FW 2.00

HS

Diagnostics

The following diagnostic functions are **not** available in the HPC-axis mode:

- Diagnostics parameter **P-020** (dn/dt monitoring), P-320, P-321
- Transient recorder function
- I/Hz controlled operation

2.3.7 Maximum current limiting (I^2t limiting, from FW 3.1)

Description

From FW 3.1 onwards, there is a maximum current limiting function to protect the power module. The characteristic can be taken from the characteristic in Fig. 2-3.

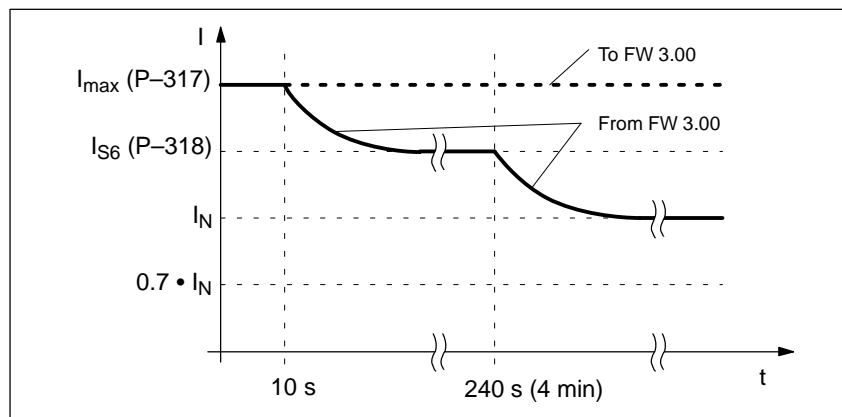

Fig. 2-3 Characteristic for standard parameterization of the I^2t limiting

The maximum current can, depending on the parameter setting, be additionally reduced (P-317, P-318). The current limiting response can be read-out via the diagnostic parameters (P-319, P-322).

Table 2-36 Parameters for I^2t limiting

Parameter attributes			Setting range	Description
Number	Change effective	P-051		
P-317	Immediately	4	25 ... 100 %	Reduction factor, max. load duty cycle I^2t The max. power module current is reduced for a 10 s load duty cycle.
P-318	Immediately	4	25 ... 100 %	Reduction factor S6, load duty cycle I^2t The max. power module current is reduced for S6 4 min load duty cycle.
(P-319)	–	–	–	Diagnostics I^2t power model The parameter indicates that the limit has become effective. Each time the current limit responds at the reduction characteristic (after 10 s), the contents of P-319 are incremented.
(P-322)	–	–	–	I^2t load limiting Actual value display of the actual limit (max. 100 % referred to P-039).

Parameterizing the Drive Converter Interfaces

3

3.1 Analog speed setpoint interface

Overview

- Speed setpoint channel selection
- Normalization, analog speed setpoint
- Unipolar speed setpoint input (fixed direction of rotation)
- Steady-state minimum speed

Speed setpoint channel selection

Table 3-1 Speed setpoint channel selection

Parameter attributes			P-051	Setting range	Description															
Number	Change effective																			
Mot. 1	Mot. 2																			
P-113	–	Online	4	0...3 dec	Channel selection, speed setpoint <table border="1"> <thead> <tr> <th>P-113</th> <th>T.56/14</th> <th>T.24/8</th> </tr> </thead> <tbody> <tr> <td>0</td> <td>Off</td> <td>Off</td> </tr> <tr> <td>1</td> <td>On</td> <td>Off</td> </tr> <tr> <td>2</td> <td>Off</td> <td>On</td> </tr> <tr> <td>3¹⁾</td> <td>On</td> <td>On</td> </tr> </tbody> </table>	P-113	T.56/14	T.24/8	0	Off	Off	1	On	Off	2	Off	On	3 ¹⁾	On	On
P-113	T.56/14	T.24/8																		
0	Off	Off																		
1	On	Off																		
2	Off	On																		
3 ¹⁾	On	On																		

1) Setpoint inputs are added

3.1 Analog speed setpoint interface

**Normalization,
analog speed
setpoint**

Table 3-2 Normalization, analog speed setpoint

Parameter attributes				Setting range	Description
Number		Change effective	P-051		
Mot. 1	Mot. 2				
P-014.1	P-258.1	Online	4	$-\overset{\text{max}}{n}_{\text{mot}}$... $\overset{\text{max}}{n}_{\text{mot}}$ RPM	Speed for max. motor useful speed Speed, which is reached for the analog input voltage in P-024. + = cw rotation for a positive speed setpoint - = ccw rotation for a positive speed setpoint
P-024	-	Online	4	5.0...15.0 V	Normalization, setpoint Analog speed setpoint voltage for P-014/P-258 Note: Max. setpoint voltage at terminals 56/14 and terminals 24/8 \pm 11 V.
P-015.1	-	Online	4	C000...4000 hex	Offset correction, speed setpoint e. g. positive correction value 2FH negative correction value FF00H

**Unipolar
speed setpoint
input**

Table 3-3 Unipolar speed setpoint input

Parameter attributes				Setting range	Description		
Number		Change effective	P-051		Control word		
Mot. 1	Mot. 2				Bit	Value	
P-053	-	Online	4	0...FFFF hex			
(from FW 2.00)					13	0000H 2000H	Bipolar speed setpoint by generating the absolute value of the speed setpoint is only permitted for one direction of rotation. The direction of rotation is defined using P-014/P-258.

**Steady-state
minimum speed**

Table 3-4 Steady-state minimum speed

Parameter attributes			Setting range	Description
Number	Change effective	P-051		
P-030	Online	4	0... $n_{\max\text{mot}}$ RPM	Steady-state minimum speed No steady-state operation in the speed range around zero. This range is passed through with the actual ramp-up or ramp-down times if the speed setpoint exceeds the steady-state minimum speed in the opposite direction of rotation. Zero speed can be forced by inhibiting the permanently wired enable signals. FW 2.00
Effective setpoint [RPM]				

HS

3.2 Input terminals



Warning

Terminal function parameters **P-081** to **P-089** may only be programmed when the pulses are canceled (terminal 63 or terminal 663 open-circuit).

3.2.1 Permanently-wired terminal functions

Table 3-5

Terminal function	Description	Terminal-number
Axis-specific pulse enable	The inverter is enabled (motor controlled) if the enable voltage is connected to terminal 663 (axis-specific pulse enable) and terminal 65 (controller enable). If the axis-specific pulse enable is withdrawn while the motor is rotating, the inverter is inhibited after 20 ms and the motor coasts down in a no-current condition.	663
Controller enable	If terminal 65 is opened while the motor is rotating, the drive brakes along the ramp-function generator ramp. When the absolute value falls below the n_{\min} threshold (P-022), the inverter is inhibited and the motor is shutdown without any reverse rotation.	65
Ramp-function generator fast stop	If the enable voltage is connected to terminal 81, the speed setpoint is enabled. When the input is open-circuit, the speed setpoint is zero (digital zero). The drive brakes without ramp-function generator along the torque limit. If bit 1 in P-053 is set, then the pulses are canceled when zero speed is reached.	81

3.2.2 Freely-programmable terminal functions

Overview

- Terminal function assignment
- Terminal functions

Terminal function assignment

Table 3-6 Terminal function assignment

Parameter attributes			P-051	Setting range	Description
Number	Change effective				
Mot. 1	Mot. 2				
P-081 to P-089	–	Online	4	1...34 dec	Terminal function assignment, E1 to E9 Terminals E1 to E9 are assigned by entering the function number. The factory setting can be taken from the following table.

Terminal functions

Table 3-7 Terminal functions

Terminal function	Description	Fct. No.	Input terminal when supplied
2nd torque limit	The 2nd torque limit becomes active, if this terminal is energized, and the changeover speed in P-050 is exceeded.	1	E1 (P-081)
Oscillation	To changeover gearbox stages, the speed setpoints, described in Section 2.2 "Standard applications" are entered.	2	E6 (P-086)
Reset fault memory (R) (fault acknowledgement)	Remotely acknowledges fault messages. Terminal 65 (controller enable) must be open in order to acknowledge.	3	E3 (P-083)
Open-loop torque controlled operation	Changeover from closed-loop speed control to open-loop torque control.	4	E5 (P-085)
Star/delta operation	Changeover between star (open) and delta operation (enable voltage).	5	–
M19 operation	Auxiliary NC function for an orientated spindle stop. When this terminal is energized, the setpoint normalization, entered in P-054, is selected if the speed falls below the value entered in P-054.	6	E4 (P-084)
Run-up time = 0	If the enable voltage is connected to this terminal, the internal ramp-function generator is bypassed.	7	E2 (P-082)
Integrator inhibit, speed controller	The speed controller integral component can be inhibited via this terminal.	8	–
Gearbox stage			
Bit 0		9	E7 (P-087)
Bit 1		10	E8 (P-088)
Bit 2		11	E9 (P-089)

3.2 Input terminals

Terminal function	Description			Fct. No.	Input terminal when supplied	
Setpoint enable (only for speed setpoint)	If this terminal is open circuit, then a setpoint of digital zero is entered. If the enable voltage is connected to the terminal, the setpoint is enabled (analog setpoint or oscillation setpoint). The setpoint is enabled if the terminal function is not selected.			16	–	
Incremental positioning	If the spindle is in position, and if the enable voltage is connected to the terminal, then the incremental position reference value in P–0123 is added to the actual position reference value. The drive then moves to this new calculated position.			22	–	
Position reference values 1...2	Together with the terminal, function No. 27, this terminal is used to select the position reference value defined using parameters P–121, P–122, P–124 and P–125 (Section 2.3.3).			23	–	
C axis	In the C–axis mode, the finer setpoint normalization, set in P–114, applies. Only setpoint input 2 is evaluated (terminals 24 and 8).			24	–	
Speed setpoint smoothing	When the enable voltage is connected to this terminal, speed setpoint smoothing is activated. The smoothing time is entered in P–018 (also with P–053).			25	–	
Suppressing F–11	If the enable voltage is connected to this terminal, fault message F–11 can be suppressed (speed controller at its endstop).			26	–	
Position reference values 3..4	Together with the terminal, function No. 23, this terminal is used to select the position reference value defined using parameters P–121, P–122, P–124 and P–125 (Section 2.3.3).			27	–	
Positioning on	If the enable voltage is connected to this terminal, positioning is started.			28	–	
Spindle re-synchronization	A positive (rising) edge at this terminal results in re-synchronization the next time that a positioning command is received via terminal, function No. 28. This function has a saving characteristic.			29	–	
HPC axis (from FW 2.00)	If the enable voltage is connected to this terminal, when bit 8 was set in P–149, the HPC–axis mode is selected.			30	–	
Slip monitoring (from FW 2.00)	If the enable voltage is connected to this terminal, the open-loop speed control with slip monitoring is activated.			32	–	
Inverter clock cycle frequency (from FW 3.00)	Term. with Fct. No.		Effective parameter Using these terminals you can toggle between four clock cycle frequencies. These clock cycle frequencies are defined using parameters P–053, P–331, P–332 and P–333 (refer to Section 4.2).	33 34		
	33	34				
	L	L				P–053
	H	L				P–331
	L	H				P–332
	H	H				P–333

3.3 Output terminals



Warning

The relay may only be programmed (**P–241 to 247**) if the pulses have been canceled (terminal 63 or terminal 663 open circuit).

3.3.1 Permanently-wired relay functions

Table 3-8 Permanently-wired relay functions

Terminal function	Description			Terminal number
Ready/no fault, axis-specific	The relay function can be selected using P–053:			672 673 674
	Bit	Value		
	0	0000H 0001H	The relay pulls-in if there is no fault and the pulses and controller have been enabled. Ready relay pulls-in if there is no fault.	
Checkback signal, start inhibit	The relay (NC contact) pulls-in if the enable voltage is connected to terminal 663 pulse enable, axis-specific.			AS1 AS2

HS

3.3.2 Freely-programmable relay functions

Overview

- Assignment of signals (messages)
- Relay functions
- Parameterizable signals (messages)
- Control word, signals (messages)

Note

The relay signals are updated with 20 ms for a 1 ms speed controller clock cycle. For a speed controller clock cycle of 0.5 ms, then 10 ms (refer to P–90 bit 3).

Signal assignments

Table 3-9 Signal assignments

Parameter attributes				Setting range	Description
Number Mot. 1	Mot. 2	Change effective	P–051		
P–241 to P–246	–	Online	4	1...20 dec	Programmable signals 1 to 6 Relay outputs A11 to A61 are assigned by entering the function number. The factory setting should be taken from the following table.

3.3 Output terminals

Relay functions

Table 3-10 Relay functions

Relay function	Description	Fct. No.	Relay output
Ramp-up completed	<p>The relay pulls-in if, after a setpoint step, the speed actual value is within the tolerance bandwidth around the new setpoint, and stays for at least 200 ms in this tolerance bandwidth. The signal then stays in the active position until the speed setpoint changes.</p> <p>The width of the tolerance bandwidth can be parameterized in P-027.</p> <p>The signal also remains active if the speed actual value leaves the tolerance bandwidth after 200 ms, unless the setpoint has in the meantime changed.</p> <p>The "Ramp-up completed" signal remains inactive if the tolerance bandwidth is left again before the 200 ms has expired.</p> <p>The relay does not drop-out due to speed fluctuations caused by load changes.</p> <p>From FW 3.00, the 200 ms time can be parameterized using P-256.</p>	2	A11 (P-241)
$ M_d < M_{dx}$	<p>The relay pulls-in for $M_d < M_{dx}$ an. This can be set using P-047.</p> <p>If the relay $n_{act} = n_{set}$ drops-out due to a speed setpoint change, the $M_d < M_{dx}$ relay can only drop-out again 800 ms after the relay $n_{act} = n_{set}$ has pulled-in again.</p> <p>From FW 3.00, the 800 ms time can be parameterized using P-257.</p>	3	A21 (P-242)
$ n_{act} < n_{min}$	The relay pulls-in for $ n_{act} < n_{min}$. This can be set using P-021.	1	A31 (P-243)
$ n_{act} < n_x$	The relay pulls-in for $n_{act} < n_x$. This can be set using P-023.	4	A41 (P-244)
Motor over-temperature pre-alarm	<p>The relay drops-out for a motor overtemperature condition. This can be set using P-063.</p> <p>If the fault condition is kept, the drive converter is powered-down with fault message F-14 after the time set in P-065.</p> <p>For short-circuit and cable interruptions, the relay is immediately switched, and is powered-down with fault message F-19 after approx. 6 s.</p>	5	A51 (P-245)
Drive converter temperature pre-alarm	<p>The relay drops-out if the main heatsink thermo switch responds.</p> <p>If the overtemperature condition remains, the drive converter is powered-down after approx. 20 s with fault message F-15.</p>	6	–
Variable relay function 1	Refer to the description "Variable relay function" in Section 3.3.3	7	A61 (P-246)
Variable relay function 2	Refer to the description "Variable relay function" in Section 3.3.3	8	–
In position 1	The relay pulls-in if the positioning program is run-through and the spindle is within the tolerance bandwidth set in P-144.	9	–
In position 2	The relay pulls-in if the positioning program is run-through and the spindle is within the tolerance bandwidth set in P-145.	10	–
Relay, star operation	This relay can control the external auxiliary contactor to changeover the winding into the star configuration.	11	–
Relay, delta operation	This relay can control the external auxiliary contactor to changeover the winding into the delta configuration.	12	–
$n_{act} = n_{set}$ (actual)	<p>The "$n_{act} = n_{set}$ (actual)" signal is active after the speed setpoint has entered the speed tolerance bandwidth around the setpoint and has remained for at least 200 ms in the tolerance bandwidth.</p> <p>If the tolerance bandwidth is left, the "$n_{act} = n_{set}$ (actual)" signal immediately becomes inactive.</p> <p>From FW 3.00, the 200 ms time can be parameterized using P-256 .</p>	20	–

Signals which can be parameterized

Table 3-11 Signals which can be parameterized

Parameter attributes				Setting range	Description
Number Mot. 1	Number Mot. 2	Change effective	P-051		
P-021.1	P-260.1	Online	4	0... n_{rated} RPM	n_{min} for "n _{act} < n _{min} " signal Response value of the n _{act} < n _{min} relay
P-023.1	P-262.1	Online	4	0... n_{maxmot} RPM	n_x for "n _{act} < n _x " signal Response value of the n _{act} < n _x relay
P-027.1	P-263.1	Online	4	0... $n_{rated}/16$ RPM	Tolerance bandwidth for "n _{act} = n _{set} " signal
P-047.1	–	Online	4	0...100 %	M_{dx} for "M _d < M _{dx} " signal This setting refers to the actual torque limiting
P256	–	Online	4	0.00...0.50	Delay time "n _{act} =n _{set} " signal, from FW 3.00
P257	–	Online	4	0.00...1.00	Delay time "M _d < M _{dx} " signal, from FW 3.00

Control word, signals

Table 3-12 Control word, signals

Parameter attributes				Setting range	Description		
Number Mot. 1	Number Mot. 2	Change effective	P-051		Bit	Value	
P-247	–	Online	4	0...FFFF hex	Control word, signals		
					0	0001H	Relay function, terminal A11 is inverted
					1	0002H	Relay function, terminal A21 is inverted
					2	0004H	Relay function, terminal A31 is inverted
					3	0008H	Relay function, terminal A41 is inverted
					4	0010H	Relay function, terminal A51 is inverted
					5	0020H	Relay function, terminal A61 is inverted

HS

3.3 Output terminals

3.3.3 Variable relay function

Table 3-13 Variable relay function

Parameter attributes			P-051	Setting range	Description		
Number Mot. 1	Mot. 2	Change effective					
P-185	–	Online	4	0...FFFF hex	Address for monitoring 1 Address of RAM variables		
P-186	–	Online	4	0...FFFF hex	Threshold for monitoring 1 Comparison value for the RAM variables content (addresses, refer to Section 6.5)		
P-187	–	Online	4	0.00...10.00 s	Pull-in delay, monitoring 1		
P-188	–	Online	4	0.00...10.00 s	Drop-out delay, monitoring 1		
P-189	–	Online	4	0...FFFF hex	Hysteresis, monitoring 1 (hysteresis for the threshold P-186)		
P-190	–	Online	4	0...FFFF hex	Address for monitoring 2		
P-191	–	Online	4	0...FFFF hex	Threshold for monitoring 2		
P-192	–	Online	4	0.00...10.00 s	Pull-in delay, monitoring 2		
P-193	–	Online	4	0.00...10.00 s	Drop-out delay, monitoring 2		
P-194	–	Online	4	0...FFFF hex	Hysteresis, monitoring 2 (hysteresis for the threshold P-191)		
P-247	–	Online	4	0...FFFF hex	Control word, signal		
					Bit	Value	
					8	0000H	Variable relay function 1 with sign interrogation
						0100H	
					9	0000H	Variable relay function 2 with sign interrogation
0200H	Variable relay function 2 with absolute value interrogation						
12	0000H	Variable relay function 1 with P-186 as threshold					
	1000H		Variable relay function 1 as bit test. The threshold (P-186) is ANDed with the RAM variables (P-185) to be monitored FW2.00				
13	0000H	Variable relay function 2 with P-191 as threshold					
	2000H		Variable relay function 2 as bit test, FW2.00				

Note

There is a list of the most important measured quantities (RAM variables) and their addresses in the Attachment (Section 6.5).

3.3.4 Motor encoder signals for NC

Table 3-14 Motor encoder signals for NC

Parameter attributes				Setting range	Description																																																																				
Number Mot. 1	Number Mot. 2	Change effective	P-051																																																																						
P-033	–	Online	4	0...7 dec	<p>Encoder resolution for NC The following multiplication factors can be set when using the squarewave-converted motor encoder signals.</p> <table border="1"> <thead> <tr> <th>P-033</th> <th>Factor</th> <th>Square-wave pulses</th> <th>Limiting speed [RPM] for RON350/ERN 1387</th> </tr> </thead> <tbody> <tr> <td>1</td> <td>1</td> <td>2048</td> <td>16000</td> </tr> <tr> <td>3</td> <td>0.5</td> <td>1024</td> <td>16000</td> </tr> <tr> <td>5</td> <td>2</td> <td>4096</td> <td>5000</td> </tr> <tr> <td>7</td> <td>4</td> <td>8192</td> <td>2500</td> </tr> <tr> <td>0</td> <td colspan="3">Up to FW 2.40, output with factor 1 From FW 3.00, pulses are not output</td> </tr> <tr> <td>0</td> <td colspan="2">Up to FW 2.40, output with factor 1 From FW 3.00, pulses are not output</td> <td>Toothed-wheel encoder 256 pulses/rev.</td> </tr> <tr> <td>1</td> <td>1</td> <td>256</td> <td>24000</td> </tr> <tr> <td>3</td> <td>0.5</td> <td>128</td> <td>24000</td> </tr> <tr> <td>5</td> <td>2</td> <td>512</td> <td>24000</td> </tr> <tr> <td>7</td> <td>4</td> <td>1024</td> <td>12000</td> </tr> <tr> <td>0</td> <td colspan="2">Up to FW 2.40, output with factor 1 From FW 3.00, pulses are not output</td> <td>Toothed-wheel encoder 512 pulses/rev.</td> </tr> <tr> <td>1</td> <td>1</td> <td>512</td> <td>12000</td> </tr> <tr> <td>3</td> <td>0.5</td> <td>256</td> <td>12000</td> </tr> <tr> <td>5</td> <td>2</td> <td>1024</td> <td>12000</td> </tr> <tr> <td>7</td> <td>4</td> <td>2048</td> <td>6000</td> </tr> <tr> <td>0</td> <td colspan="3">Up to FW 2.40, output with factor 1 From FW 3.00, pulses are not output</td> </tr> </tbody> </table>	P-033	Factor	Square-wave pulses	Limiting speed [RPM] for RON350/ERN 1387	1	1	2048	16000	3	0.5	1024	16000	5	2	4096	5000	7	4	8192	2500	0	Up to FW 2.40, output with factor 1 From FW 3.00, pulses are not output			0	Up to FW 2.40, output with factor 1 From FW 3.00, pulses are not output		Toothed-wheel encoder 256 pulses/rev.	1	1	256	24000	3	0.5	128	24000	5	2	512	24000	7	4	1024	12000	0	Up to FW 2.40, output with factor 1 From FW 3.00, pulses are not output		Toothed-wheel encoder 512 pulses/rev.	1	1	512	12000	3	0.5	256	12000	5	2	1024	12000	7	4	2048	6000	0	Up to FW 2.40, output with factor 1 From FW 3.00, pulses are not output		
P-033	Factor	Square-wave pulses	Limiting speed [RPM] for RON350/ERN 1387																																																																						
1	1	2048	16000																																																																						
3	0.5	1024	16000																																																																						
5	2	4096	5000																																																																						
7	4	8192	2500																																																																						
0	Up to FW 2.40, output with factor 1 From FW 3.00, pulses are not output																																																																								
0	Up to FW 2.40, output with factor 1 From FW 3.00, pulses are not output		Toothed-wheel encoder 256 pulses/rev.																																																																						
1	1	256	24000																																																																						
3	0.5	128	24000																																																																						
5	2	512	24000																																																																						
7	4	1024	12000																																																																						
0	Up to FW 2.40, output with factor 1 From FW 3.00, pulses are not output		Toothed-wheel encoder 512 pulses/rev.																																																																						
1	1	512	12000																																																																						
3	0.5	256	12000																																																																						
5	2	1024	12000																																																																						
7	4	2048	6000																																																																						
0	Up to FW 2.40, output with factor 1 From FW 3.00, pulses are not output																																																																								

HS

3.3.5 Analog outputs

Overview

- Function
- Technical data
- Parameterization DAU 1, DAU 2
- Fine normalization

Function

Analog output of RAM variables for measuring and diagnostics

Technical data

- 2 output channels at terminal A91 (DAU 1) and terminal A92 (DAU 2)
- Voltage range ± 10 V
- Coarse normalization, offset compensation
- Signal resolution, 7 bits + sign
- Fine normalization for
 - speed actual value (absolute)
 - utilization
 - M/M_{rated}
- The polarity of the output voltage can be set using the fine normalization (± 200 %)
- Factory setting:
 - A91 $\hat{=}$ 10 V, if the max. speed is reached ($n_{\text{act}} = P-029$)
 - A91 $\hat{=}$ 10 V, if the torque or power is reached ($M_{\text{dmax}}, P_{\text{max}} = P-039$)

Parameterization DAU 1, DAU 2

Table 3-15 Parameterization DAU 1, DAU 2

Parameter attributes			P-051	Setting range	Description
Number	Change effective				
Mot. 1	Mot. 2				
P-066	–	Online	4	0...FFFF hex	Address, DAU 1 Address of the RAM variables which are to be output at DAU 1. Default: n/n_{\max} (RAM address: 3044H) Setting example: Motor temperature in °C → RAM address: Shift FC2 via P-067
P-067	–	Online	4	0...15 dec	Shift factor DAU 1 The selected data value is shifted to the left 1 corresponds to multiplication by 2 n corresponds to multiplication by 2^n
P-078	–	Online	4	7F...FF80 hex	Offset DAU 1 A possible offset for DAU 1 is compensated
P-068	–	Online	4	0...FFFF hex	Address, DAU 2 Default: Utilization (M/M_{\max} or P/P_{\max}) (RAM address: 3048H) Smoothing can be set using P-071.
P-069	–	Online	4	0...15 dec	Shift factor DAU 2
P-079	–	Online	4	7F...FF80 hex	Offset DAU 2

Output voltage [V]

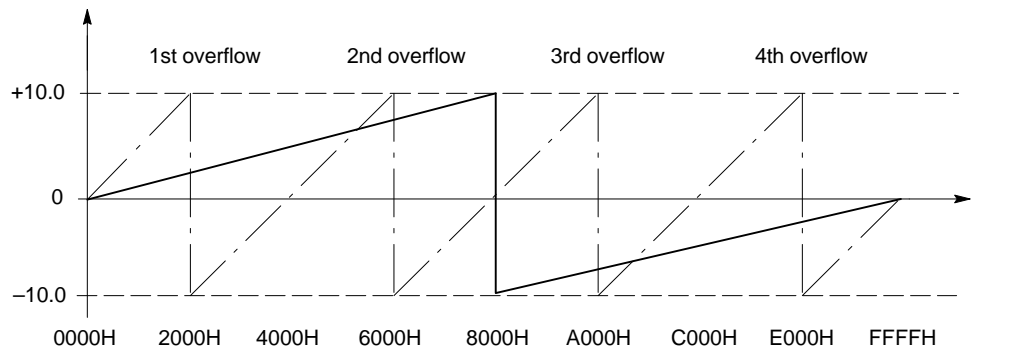

— Shift factor = 0
- - - Shift factor = 2

Offset = 0 V
Fine normalization = 100 %

Hex numerical value

HS

3.3 Output terminals

Fine normalization The coarse normalization (**P-067**, **P-069**) must be set to 0H, otherwise the overcontrol protection of the DAUs (D/A converters) is not effective.

Table 3-16 Fine normalization

Parameter attributes			P-051	Setting range	Description
Number	Change effective				
Mot. 1	Mot. 2				
P-012	–	Online	4	–200.0...200.0 %	Normalization, DAU n_{act} display For P-012 = 100 %, the following is valid: Max. speed (P-029) corresponds to +10 V. Only acts on address 3044H, pre-set to DAU1. From FW 3.00, update clock cycle is 1ms (previously 20ms)
P-013	–	Online	4	–200.0...200.0 %	Normalization, DAU utilization display Utilization display $n = 0$ to n_{rated} : M_d/M_{dmax} $n > n_{rated}$: P/P_{max} (takes into account the actual torque limits P-039, P-041) For P-013 = 100 %, the following is valid: Max. torque or power corresponds to +10V. This is only effective on address 3048H, pre-set to DAU2. From FW 2.40, update clock cycle is 1ms (previously 20ms)
P-026	–	Online	4	–200.0...200.0 %	Normalization, DAU M/M_{rated} For P-026 = 100 %, the following is valid: Rated torque corresponds to +5 V M/M _{rated} is signed, i. e. a negative rated torque corresponds to –5 V. Is only effective at address 304CH. From FW 3.00, update clock cycle is 1ms (previously 20ms)
P-071	–	Online	4	2...32767 ms	Smoothing time, DAU utilization display (from FW 2.40, not in the HPC-axis mode) Output via address 3048H, pre-set to DAU2

Note

There is a list of the most important measured quantities (RAM variables) and their addresses in the Attachment (Section 6.5).



4

Controller Optimization

4.1 Speed controller optimization

Overview

- Speed setpoint smoothing
- Speed actual value smoothing
- Ramp–function generator
- Gain, integral action time
- Speed controller adaptation
- Torque, speed setpoint smoothing (pT_1)
- Digital filter, torque setpoint channel
- Delay time, “speed controller at its endstop”

HS

Speed setpoint smoothing

Table 4-1 Speed setpoint smoothing

Parameter attributes				Setting range	Description		
Number	Change effective	P–051					
Mot. 1	Mot. 2						
P–018	–	Online	4	3...10000 ms	Smoothing time, speed setpoint smoothing (enabled/disabled using P–053 or via select terminal function No. 25)		
P–019	–	Online	4	0...30 dec	Degree of rounding–off, speed setpoint (pT_2 element) This is only effective when the speed setpoint smoothing is active. 0: No rounding–off 30: Max. rounding–off		
P–053	–	Online	4	0...FFFF hex	Control word		
					Bit	Value	
					4	0000H 0010H	Speed setpoint smoothing inactive Speed setpoint smoothing active

4.1 Speed controller optimization

Speed actual value smoothing

Table 4-2 Speed actual value smoothing

Parameter attributes				Setting range	Description	
Number	Change effective	P-051				
Mot. 1	Mot. 2					
P-034	–	Online	4	1...10 ms	Smoothing time, speed actual value smoothing (enabled/disabled using P-053, bit 5) FW 3.00 This is only possible for a 1 ms speed controller sampling (P-090.3 = 0).	
P-053	–	Online	4	0...FFFF hex	Control word	
				Bit	Value	
				5	0000H 0020H	Speed actual value smoothing inactive Speed actual value smoothing active If simultaneously P-090 bit 3=0 (speed controller clock cycle=1 ms)

Ramp-function generator

Table 4-3 Ramp-function generator

Parameter attributes				Setting range	Description	
Number	Change effective	P-051				
Mot. 1	Mot. 2					
P-016.1	–	Online	4	0.01...64.00 s	Ramp-up time, ramp-function generator From $n = 0$ to n_{\max} (P-029)	
P-017.1	–	Online	4	0.01...64.00 s	Ramp-down time, ramp-function generator From n_{\max} (P-029) to $n = 0$	
P-053	–	Online	4	0...FFFF hex	Control word	
				Bit	Value	
				12	0000H 1000H	Ramp-funct. generator tracking active Ramp-funct. generator tracking inactive

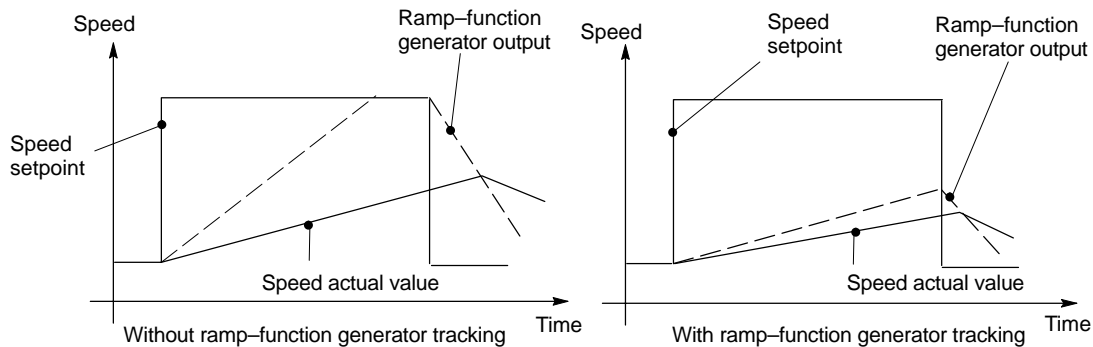

Gain, integral action time

Table 4-4 Gain, integral action time

Parameter attributes				Setting range	Description	
Number		Change effective	P-051			
Mot. 1	Mot. 2					
P-031.1	P-265.1	Online	4	3.0...120.0 dec ¹⁾	P gain, speed controller	
P-032.1	P-266.1	Online	4	5...6000 ms	Integral action time, speed controller	
P-090	–	Online	4	0...FFFF hex	Control word	
					Bit	
					Value	
					6	0000H 0040H The integral component is set to 0 if the speed controller is controlled to its maximum. The integrator is held if the speed controller is controlled to its maximum. FW 2.00

HS

1) From FW 3.10: 6.0...240.0 dec

4.1 Speed controller optimization

Speed controller adaptation

Table 4-5 Speed controller adaptation

Parameter attributes			P-051	Setting range	Description	
Number Mot. 1	Number Mot. 2	Change effective				
P-195	P-283	Online	4	0... $n_{\max\text{mot}}$ RPM	Lower adaptation speed	
P-196	P-284	Online	4	0... $n_{\max\text{mot}}$ RPM	Upper adaptation speed	
P-198	P-285	Online	4	1.0...120.0 dec ¹⁾	P gain, upper adaptation speed	
P-199	P-286	Online	4	1...200 %	Reduction factor, P gain (the P gain characteristic is multiplied over the complete speed range)	
P-201	P-288	Online	4	5...6000 ms	Integral action time, upper adaptation speed	
P-202	P-289	Online	4	1...200 %	Reduction factor, integral action time (the integral action time characteristic is multiplied over the complete speed range)	
P-203	P-293	Online	4	0...7 dec	Control word adaptation speed controller Adaptation is only possible in gearbox stage 1!	
				Bit	Value	
				1	0000H 0002H	No adaptation Speed controller adapt. active

The graph plots P gain [dec] and Integral action time [ms] against Speed [RPM]. The y-axis represents P gain [dec] and Integral action time [ms], with specific values P-032.1 and P-031.1 marked. The x-axis represents Speed [RPM], with adaptation points P-195 and P-196 marked. Two lines represent the characteristics: one for P gain (decreasing with speed) and one for Integral action time (increasing with speed). Vertical dashed lines at P-195 and P-196 indicate the lower and upper adaptation speeds. Arrows indicate the influence of parameters P-199 and P-202 on the P gain line, and P-198 and P-201 on the Integral action time line.

1) From FW 3.10: 6.0...240.0 dec

**Torque setpoint
smoothing (pT₁)**Table 4-6 Torque setpoint smoothing (pT₁)

Parameter attributes		Change effective	P-051	Setting range	Description
Number Mot. 1	Mot. 2				
P-035	–	Online	4	3...10000 ms	Smoothing time, torque setpoint smoothing
P-045	P-274	Online	4	1...n _{maxmot} RPM	Switch-in speed, torque setpoint smoothing The torque setpoint smoothing is switched-in above this speed
P-046	P-275	Online	4	0...n _{rated} RPM	Hysteresis P-045/P-275
P-044	–	Online	4	0...1 hex	Select torque setpoint smoothing 0: No torque setpoint smoothing 1: Torque setpoint smoothing above the switch-in speed P-045

4.1 Speed controller optimization

Digital filter ,
torque setpoint
channel

Table 4-7 Digital filter, torque setpoint channel

Parameter attributes				P-051	Setting range	Description
Number Mot. 1	Number Mot. 2	Change effective				
P-118	P-281	Online Online	4 4	0...FFFF hex 0...1 hex	Torque setpoint filter type 0: Bandstop characteristics 1: Lowpass characteristics	
P-103	P-276	Online	4	50...450 Hz	Torque setpoint filter frequency Lowpass: 3 dB transition frequency Bandstop: Center frequency	
P-104	P-277	Online	4	0.10...10.00 dec	Torque setpoint filter quality Filter quality of the bandstop, quality = 1 corresponds to 1.00	
P-117	P-280	Online Online	4 4	0...FFFF hex 0...1 hex	Torque setpoint filter selection 0: Digital filter is disabled 1: Digital filter is enabled	

Amplitude

3dB {

P-103
Lowpass

Frequency [Hz]

Amplitude

P-104 ≈ 2

P-104 ≈ 0.5

P-103
Bandstop

Frequency [Hz]

Delay time, “speed
controller at its
endstop”

Table 4-8 Delay time, “speed controller at its endstop”

Parameter attributes				P-051	Setting range	Description
Number Mot. 1	Number Mot. 2	Change effective				
P-248	–	Online	4	100...10000 ms	Delay time, fault message F-11 The fault message is output, if the speed controller is fully controlled for the time specified in P-248, and if the speed actual value does not exceed the internal threshold $n_{rated}/256$.	

4.2 Current controller optimization

Note

Generally, it is not necessary to change the following parameters, as the optimum current controller settings can be calculated from the motor and power module data.

Overview

- Current controller
- Inverter clock cycle frequency

Current controller

Table 4-9 Current controller

Parameter attributes			P-051	Setting range	Description
Number Mot. 1	Number Mot. 2	Change effective			
P-116	P-278	Online	4	-255...255 dec	Correction, P gain current controller A signed offset is added to the current controller P gain.
P-120	P-292	Online	4	500...10000 RPM	Changeover speed, current controller adaptation The current controller P gain is increased when the speed is exceeded.
(P-316)	-	Online	4	-	Display, current controller P gain The currently effective P gain of the current controller is displayed.

HS

4.2 Current controller optimization

Inverter clock cycle frequency

Table 4-10 Inverter clock cycle frequency1

Parameter attributes				Setting range	Description
Number		Change effective	P-051		
Mot. 1	Mot. 2				
P-053	–	Online	4	0...FFFF hex	Control word
					Bit
					Value
					Pulse frequency [kHz]
					8
					9
					10
					0000H
					0200H
					0400H
					0600H
					0100H
					0300H
					0500H
					0700H
					3.2
					6.3
					4.7
					7.8
					2.8 from FW 3.00
					5.0 from FW 3.00
					3.9 from FW 3.00
					5.9 from FW 3.00
Note:					
An inverter clock cycle frequency > 3.2 kHz is only possible if the output is de-rated (refer to Table 1–3).					

Table 4-11 Inverter clock cycle frequency 2, 3 and 4

Parameter attributes				Setting range	Description
Number		Change effective	P-051		
Mot. 1	Mot. 2				
P-331	–	Online	4	0–7hex	Inverter clock cycle frequency 2 from FW 3.00
P-332	–	Online	4	0–7hex	Inverter clock cycle frequency 3 from FW 3.00
P-333	–	Online	4	0–7hex	Inverter clock cycle frequency 4 from FW 3.00
Settings					
					Value
					Pulse frequency[kHz]
					0000
					0001
					0002
					0003
					0004
					0005
					0006
					0007
					3.2
					2.8
					6.3
					5.0
					4.7
					3.9
					7.8
					6.1
(P-330)	–	Online	–	2.8–7.8kHz	Displays the actual clock cycle frequency

The inverter clock cycle frequencies, set using these parameters, can be changed-over using input terminals (refer to Section 3.2.2).



5

Diagnosics and Fault Analysis

5.1 Diagnostic resources

5.1.1 Measured value displays

Table 5-1 Measured value displays

Parameter attributes		Change effective	P-051	Setting range	Description
Number					
Mot. 1	Mot. 2				
(P-001)	–	–	–	–20000...20000 RPM	Speed setpoint
(P-002) (P-102)	–	–	–	–20000...20000 RPM	Speed actual value
(P-003)	–	–	–	0...500 V	Motor voltage
(P-004)	–	–	–	0...100.0 %	Utilization (referred to the actual torque limit)
(P-006)	–	–	–	0...700 V	DC link voltage
(P-007)	–	–	–	0...150 A	Motor current
(P-008)	–	–	–	0...100 kVA	Motor reactive power
(P-009)	–	–	–	0...100 kW	Motor active power
(P-010)	–	–	–	0...150 °C	Motor temperature
(P-101)	–	–	–	–200...200 %	Setpoint for open-loop torque controlled operation
(P-330)	–	–	–	2.8...7.8 kHz	Inverter clock cycle frequency

HS

5.1 Diagnostic resources

5.1.2 Status displays

P-000, P-100
operating display

Refer to Section 2.2.1, Table 2-10







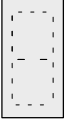

P-011
status of the
digital inputs

Table 5-2 P-011 status of the digital inputs

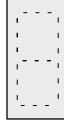
Display						
Display value						
	–	Term. 63 central pulse enable NE	Term. E6 freely-programmable using P-086	Term. E2 freely-programmable using P-082	Term. 663 axis-specific pulse enable	
	–	Term. 64 central controller enable NE	Term. E7 freely-programmable using P-087	Term. E3 freely-programmable using P-083	Term. 65 axis-specific controller enable	
	–	–	Term. E8 freely-programmable using P-088	Term. E4 freely-programmable using P-084	Term. 81 open ramp-function generator fast stop	
	–	–	Term. E9 freely-programmable using P-089	Term. E5 freely-programmable using P-085	Term. E1 freely-programmable using P-081	
Several messages can be displayed. The hexadecimal addition is displayed. Example: 4H + 8H = CH						

P-254
display, active
functions 1

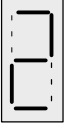
Table 5-3 P-254 display, active functions 1

Display						
Display value						
	–	–	Fct. No. 9 Gearbox stage bit 0	Fct. No. 5 Star/delta	Fct. No. 1 2nd torque limit	
	–	–	Fct. No. 10 Gearbox stage bit 1	Fct. No. 6 M19 operation	Fct. No. 2 Oscillation	
	–	–	Fct. No. 11 Gearbox stage bit 2	Fct. No. 7 $T_H = 0$	Fct. No. 3 Reset fault memory (fault acknowledgement)	
	–	Fct. No. 16 Setpoint enable	–	Fct. No. 8 Integrator inhibit, speed controller	Fct. No. 4 Open-loop torque controlled operation	
Several messages can be displayed. The hexadecimal addition is displayed. Example: 4H + 8H = CH						

HS

5.1 Diagnostic resources

P-255
display, active
functions 2

Table 5-4 P-255 display, active functions 2

Display						
Display value						
	–	Fct. No. 26 Suppress F-11	–	–	Fct. No. 32 Slip monitoring	
	–	Fct. No. 23 Pos. reference values 1...2	Fct. No. 30 HPC axis	–	Fct. No. 33 Inverter clock cycle frequency bit 0	
	–	Fct. No. 27 Pos. reference values 3...4	Fct. No. 24 C axis	Fct. No. 22 Incremental positioning	Fct. No. 34 Inverter clock cycle frequency bit 1	
	–	Fct. No. 28 Positioning on	Fct. No. 25 Speed setpoint smoothing active	Fct. No. 29 Spindle re-synchronization	–	
Several messages can be displayed. The hexadecimal addition is displayed. Example: 4H + 8H = CH						

5.1.3 Diagnostic parameters

Table 5-5 Diagnostic parameters

Parameter attributes				Setting range	Description		
Number Mot. 1	Number Mot. 2	Change effective	P-051				
(P-020)	–	–	–	–	Diagnostics, speed actual value If this is continually increased by several increments, then there is an increased noise signal level. (counter for dn/dt monitoring) Possible causes: <ul style="list-style-type: none"> Encoder shield not grounded Defective encoder Electronics ground not OK Motor ground not connected to the MSD module Measuring circuit 1 defective An excessive motor moment of inertia was entered (P-159, P-219) 		
(P-028)	–	–	–	–	Diagnostics		
					Bit	Value	
					3	0008H	Pre-alarm, temperature sensor <ul style="list-style-type: none"> Breakage Short-circuit
		13	2000H	Division interrupt due to an error in the calculation routine due to incorrectly entered data.			
(P-299)	–	–	–	–	Checksum parameter At each data save operation (P-052 = 1H), the checksum is formed across the parameter contents. This means that a change in the drive machine data is identified.		
(P-320)	–	–	–	–	Diagnostics, motor encoder zero from FW 3.00 If this is continually increased by several increments, then there is an increased noise signal level. Possible causes: <ul style="list-style-type: none"> Encoder shield not grounded Defective encoder Electronics ground not OK Motor ground not connected to the MSD module Measuring circuit defective 		
(P-321)	–	–	–	–	Diagnostics, spindle encoder zero from FW 3.00 Prerequisite: Positioning with spindle encoder is selected, spindle encoder pulse number in P-131.x is to the power of 10. There is an increased noise level, if this continually increases by several increments. Possible causes: <ul style="list-style-type: none"> Encoder shield not grounded Defective encoder Electronics ground not OK Motor ground not connected to the MSD module Measuring circuit defective 		

5.1.4 Test sockets X1, X2, IR

Overview

- Function
- Technical data
- Assignment
- Normalization IR
- Parameterization X1 (DAU 3), X2 (DAU 4)

Function

Analog output of the phase current actual value and RAM variables for test and diagnostic purposes.

Technical data

- Phase current actual value at test socket IR
- 2 output channels at X1 (DAU 3) and X2 (DAU 4)
- Voltage range 0...+ 5 V (value 0 corresponds to +2.5 V)
- Coarse normalization, offset compensation for X1 and X2 via parameter

Assignment

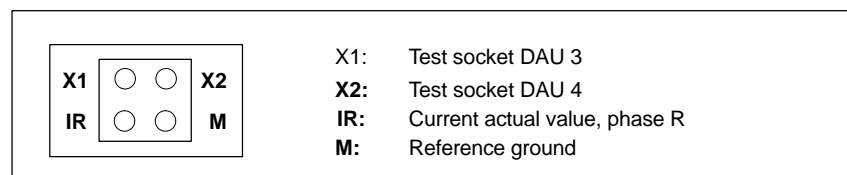

Fig. 5-1 Assignment, test sockets

Normalization, phase current IR

Table 5-6 Normalization IR

Power module	Power module code numbers (P-095)	Normalization IR
50 A	6	50 A corresponds to 8.25 V
80 A	7	80 A corresponds to 8.25 V
120 A	8	160 A corresponds to 8.25 V
160 A	9	160 A corresponds to 8.25 V
200 A	10	200 A corresponds to 8.25 V
300 A	11	300 A corresponds to 8.25 V
400 A	12	400 A corresponds to 8.25 V
108 A	13	120 A corresponds to 8.25 V

Parameterization X1 (DAU 3), X2 (DAU 4)

Table 5-7 Parameterization X1 (DAU 3), X2 (DAU 4)

Parameter attributes			P-051	Setting range	Description
Number	Change effective				
Mot. 1	Mot. 2				
P-076	–	Online	4	0...FFFF hex	Address, DAU 3 Address of the RAM variables which are to be output at DAU 3. Pre-setting: $ P/P_{rated} $ (RAM address: 3050H)
P-077	–	Online	4	0...15 dec	Shift factor DAU 3 The selected data values are shifted to the left 1 corresponds to multiplication by 2 n corresponds to multiplication by 2^n
P-080	–	Online	4	7F...FF80 hex	Offset DAU 3 Compensates any existing offset for DAU 3
P-072	–	Online	4	0...FFFF hex	Address DAU 4 Pre-setting: n_{act} (RAM address: C04H)
P-073	–	Online	4	0...15 dec	Shift factor DAU 4
P-074	–	Online	4	7F...FF80 hex	Offset DAU 4

Output voltage [V]

Hex numerical value

——— Shift factor = 0 Offset = 0 V
 - - - Shift factor = 2 Fine normalization = 100 %

HS

Note

A list of all of the important measured quantities (RAM variables) and their addresses are provided in the Attachment (Section 6.5).

5.1.5 Minimum/maximum value memory

Function RAM variables are monitored for minimum and maximum values.

Table 5-8 Minimum/maximum value memory

Parameter attributes				P-051	Setting range	Description
Number		Change effective	Mot. 1			
P-181	–			Online	4	0...FFFF hex
P-179	–	Online	4	0...2 hex	Select min/max memory 0H: Stop memory function 1H: Start memory function with absolute value evaluation 2H: Start memory function with bipolar evaluation	
(P-182)	–	–	–	–	Minimum value, min/max memory	
(P-183)	–	–	–	–	Max. value, min/max memory	

Note

A list of all of the important measured quantities (RAM variables) and their addresses are provided in the Attachment (Section 6.5).

5.1.6 Transient recorder function

Function 2 RAM variables are simultaneously recorded and output via test sockets X1 and X2.

Technical data

- Two 16-bit signals are recorded in parallel
- 640 value recording depth
- 1 ms sampling time (P-090, bit 3=0) or 0.525 ms (P-090, bit 3=1, from FW 3.00)
- Start and stop conditions (trigger conditions)
- Cyclic output via DAUs
- Trigger condition for output

Parameterization

Table 5-9 Parameterization

Parameter attributes			P-051	Setting range	Description
Number	Change effective				
Mot. 1	Mot. 2				
P-207	–	Online	4	0...10 hex	Setting the transient recorder 1H: Start via P-206 without start and stop condition 2H: Start condition P-208 and P-209, no stop condition, start via P-206 5H: Stop condition via P-210 and P-211, no start condition, start via P-206 6H: Record with start and stop condition 4H: Trace memory pre-set via P-217
P-212	–	Online	4	0...FFFF hex	Address, signal 1 There is a list of the important measured quantities (RAM variables) and their addresses in the Attachment (Section 6.5).
P-213	–	Online	4	0...FFFF hex	Address, signal 2
P-208	–	Online	4	0...FFFF hex	Address for the start condition Address of the RAM variables which start the recording
P-209	–	Online	4	0...FFFF hex	Threshold for the start condition Start condition mask, this is compared with the RAM variable in P-208
P-210	–	Online	4	0...FFFF hex	Address for the stop condition
P-211	–	Online	4	0...FFFF hex	Threshold for the stop condition
P-206	–	Online	4	0...1 hex	Select transient recorder Starts the transient recorder function by setting to 1H
P-215	–	Online	4	0...15 dec	Shift factor, signal 1 Refer to the description of test sockets X1, X2, Section 5.1.4
P-216	–	Online	4	0...15 dec	Shift factor, signal 2
P-217	–	Online	4	0...FFFF hex	Trigger signal 1 Trigger signal amplitude "low" for DAU output
P-218	–	Online	4	0...FFFF hex	Trigger signal 2 Trigger signal amplitude "high" for DAU output
P-214	–	Online	4	0...1 hex	Start output of the recorded trace The recorded values are cyclically output at the DAU Recorded signal 1 → DAU 3 (X1) Recorded signal 2 → DAU 4 (X2) The previous assignment of the DAUs is buffered and is re-selected after the output function has been completed.

HS

Note

A list of all of the important measured quantities (RAM variables) and their addresses are provided in the Attachment (Section 6.5).

5.1.7 Current/Hz control

Function Diagnostics for motor encoder faults

Function information Above the speed at the start of field weakening (**P-173**), the absolute current should be selected to be lower than the no-load current, as otherwise voltage limiting will become active. This will result in uneven running and torque surges. The frequency should be slowly changed, as current/Hz operation is prone to stalling.

Table 5-10 Current/Hz control

Parameter attributes		Change effective	P-051	Setting range	Description
Number	Number				
Mot. 1	Mot. 2				
P-311	–	Online	4	0.0...100.0 %	Current for current/Hz control (referred to the rated motor current)
P-312	–	Online	4	0.0...800.0 Hz	Frequency for current/Hz control
P-313	–	Online	4	0...1hex	Select current/Hz control 0H: Current/Hz control off 1H: Current/Hz control on

5.2 Fault analysis

5.2.1 Fault display, fault acknowledgement

Fault display

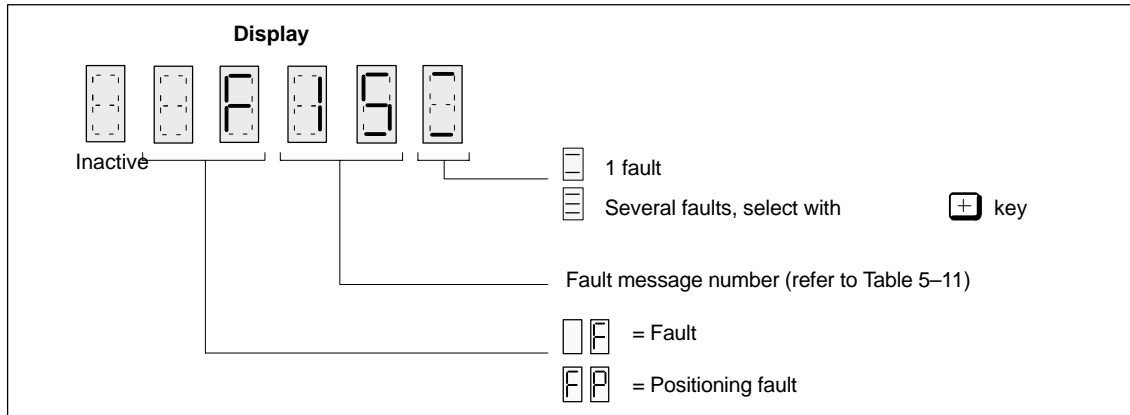

Fig. 5-2 Fault display

Fault acknowledgement

By

- **P** key

Press the **P** key if the controller is inhibited.

If the fault can be acknowledged, the system returns to the operator control program.

If the fault cannot be acknowledged, as, for example, there is a defect, then this can be temporarily suppressed in the display.

- **Remote acknowledgment**

One of the following terminals is controlled for controller inhibit:

- Terminal "R" RESET at the NE and monitoring module
- Terminal "Reset fault memory" at the MSD module

- **Powering-down**

Power-down the unit and power-up again approx. 2 s after the display goes dark.

Fault suppression

Using

- **-** key

The system returns to the operator control program for approx. 1 minute after pressing the **-** key; however, the fault is not acknowledged.

5.2 Fault analysis

5.2.2 Fault message list

Table 5-11 Fault message list

Fault message	Fault	Cause	Removing the fault
F-04	Incorrect setpoint value conversion	<ul style="list-style-type: none"> A/D converter faulted (setpoint channel) 	<ul style="list-style-type: none"> If this is repeated, replace the control board
F-07	Data save on the FEPRM was unsuccessful	<ul style="list-style-type: none"> If the fault message is repeated, while a data save is being made, then the FEPRM is defective. If the fault message occurs immediately after powering-up the drive converter, then the drive converter was previously powered-down during a data save operation. This means that the last parameter changes are not saved. A new data save operation must be initiated. 	<ol style="list-style-type: none"> Re-start data save via P52=1 If fault F-07 occurs again, replace the control board
F-08	Irretrievable data loss	<ul style="list-style-type: none"> Defective FEPRM 	<ul style="list-style-type: none"> Replace the control board
F-09	Fault, encoder system 1 (motor encoder)	<ul style="list-style-type: none"> Motor encoder not connected or defective Motor encoder cable defective Measuring circuit 1 (speed actual value sensing) defective, not correctly inserted or incorrectly equipped (P-150). <p>The fault message can be suppressed via P-090 bit 1 from FW 2.00 onwards.</p>	<ul style="list-style-type: none"> Check the encoder cable/shielding, or Replace the motor encoder, or Replace the control board
F-10	Fault equipping parameterization encoder system 2	<ul style="list-style-type: none"> Positioning with spindle encoder selected (P141=1, P143=1), incorrect module version FW 1/2 Positioning with spindle encoder selected (P141=1, P143=1), there is no spindle encoder at X432 FW 3.00 Positioning with spindle encoder (P141=1, P143=1) and output of squarewave-converted motor encoder signals X432 selected (P033<>0) FW 3.00 Output of squarewave-converted motor encoder signals at X432 selected (P033<>0), there is a spindle encoder at X432 FW 3.00 	<ul style="list-style-type: none"> Correctly adapt P33 (refer to the Start-up Guide, Section 3.3.4) Replace with the correct control board version Connect the spindle encoder

Table 5-11 Fault message list

Fault message	Fault	Cause	Removing the fault
F-11	Speed controller is at its limit, speed actual value missing	<ul style="list-style-type: none"> • Motor overloaded • DC link busbars not connected • DC link fuse defective • Defective transistor in the power module • Motor encoder not connected • Defective motor encoder cable • Defective motor encoder • Motor ground not connected • Motor encoder cable shield not connected • Motor not connected or phase missing • Motor stalled • Measuring circuit 1 (speed actual value sensing) defective or not correctly connected <p>(The delay time can be set via P-248.)</p>	<ul style="list-style-type: none"> • Avoid motor overload (P004<100%) • Tighten the DC link busbars • Replace the power module • Connect the motor encoder • Replace the motor encoder • Check the PE/motor connection • Ground the shield or replace the encoder cable • Correctly connect the motor phases • Release the motor (mech. blockage) • Contactor between the motor and drive converter must be closed • Replace the control board
F-14	Motor overtemperature	<ul style="list-style-type: none"> • Motor overloaded • Motor current too high, e. g. due to incorrect motor data (P-096) • Defective temperature sensor (motor) • Defective motor fan • Measuring circuit 1 (speed actual value – motor) defective • Winding short, motor 	<ul style="list-style-type: none"> • Reduce the motor load • Correct the motor data • Changeover to the 2nd temperature sensor • Connect the fan • Replace the control board or motor encoder • Replace the motor
F-15	Drive converter overtemperature	<ul style="list-style-type: none"> • Drive converter overloaded (incorrect motor/drive converter assignment, incorrect load duty cycle) • Ambient temperature too high • Fan failed • Inverter clock cycle frequency greater than 3.2 kHz • Temperature sensor defective <p>Acknowledgement: Only after cooling-down below 50°C ± 15K, by powering-down and powering-up again.</p>	<ul style="list-style-type: none"> • Correct the motor/drive converter assignment (P95/96). Reduce the M_d limit (P39) • Power module too small • Replace power module • Reduce clock cycle frequency
F-16	Illegal power module code	<ul style="list-style-type: none"> • Incorrect code number 3 selected in P-095 (for power modules without automatic recognition) • Incorrect code number selected in P-095 (for power modules with automatic recognition) from FW 3.00 	<ul style="list-style-type: none"> • Load the correct code number
F-17	I ₀ motor > I _{rated} power module	<ul style="list-style-type: none"> • Incorrect motor/drive converter assignment 	<ul style="list-style-type: none"> • Correctly set I₀ motor, or • Use a larger power module

5.2 Fault analysis

Table 5-11 Fault message list

Fault message	Fault	Cause	Removing the fault
F-18	Fault, encoder system 2 (spindle encoder)	<ul style="list-style-type: none"> Spindle encoder not connected or defective FW 3.00 Defective spindle encoder cable FW 3.00 Measuring circuit 2 defective FW 3.00 <p>The fault message can be suppressed via P-090 bit 5.</p>	<ul style="list-style-type: none"> Connect or replace the spindle encoder Check the connecting cable, encoder/drive converter Replace the control board
F-19	Temperature sensor <ul style="list-style-type: none"> Interrupted Short-circuit 	<ul style="list-style-type: none"> Temperature sensor defective (PTC thermistor at 20°C \approx 600 Ω, if required, use the 2nd PTC thermistor of the motor) Sensor connection interrupted Measuring circuit 1 defective <p>Acknowledgement: Only by powering-down and powering-up.</p>	<ul style="list-style-type: none"> Replace the temperature sensor Re-establish the connection between the temperature sensor and motor/drive converter Replace the control board
F-61	Max. motor frequency exceeded	<ul style="list-style-type: none"> Incorrectly entered encoder pulse number (P-098) FW 2.00 Master/slave have no force-locked connection 	<ul style="list-style-type: none"> Correctly enter the encoder pulse number (P98) Re-establish the mechanical force-locked connection (slave drive)
F-79	Division interrupt (message can be suppressed by setting P-053, bit 11)	<ul style="list-style-type: none"> Incorrect motor data in P-159 to P-176 or P-219 to P-236 Field weakening > 1:16 	<ul style="list-style-type: none"> Correctly set the motor data Field weakening < 1:16
FP-01	Setpoint > encoder pulse number	<ul style="list-style-type: none"> Setpoint input too high (P-121 to P-125, P-131). External position reference value 	<ul style="list-style-type: none"> Setpoint input must be set lower (max P131)
FP-02	Zero mark monitoring has responded	<ul style="list-style-type: none"> Zero mark signal from the encoder or BERO interrupted Incorrect parameterization (P-131) 	<ul style="list-style-type: none"> Set the Bero clearance lower or replace the BERO Replace the cabling Replace the encoder Parameter setting in P131 greater than the pulse number per revolution
FP-03	Zero mark shift > encoder pulse number	<ul style="list-style-type: none"> Value in P-130 > than the pulse number in P-131 	<ul style="list-style-type: none"> The entry in P-130 must be set lower than the value in P-131

Table 5-11 Fault message list

Fault message	Fault	Cause	Removing the fault
FP-04	No valid zero mark	There is no valid zero mark when setting P-129 to 1, e. g.: <ul style="list-style-type: none"> • After power-up • After the gearbox stage change 	<ul style="list-style-type: none"> • Rotate the spindle at least through one revolution (rotate through 360⁰ and again set P129 to 1). Check the zero mark if the fault is still present. • If a BERO is being used, adjust the clearance, check the cabling or replace the Bero. • For spindle/motor encoder, check the cabling or replace the encoder.
F-60	Power offset adjustment	<ul style="list-style-type: none"> • Pulse and/or controller enable missing 	<ul style="list-style-type: none"> • Enable the pulses and controller. Only then can the adjustment be started (to FW 2.40)

Faults

After

- **Power ON**

Operating display inactive

- minimum two phases missing (NE/monitoring module)
- at least two input fuses have failed (NE/monitoring module)
- electronics power supply in the NE/monitoring module defective
- equipment bus connection (ribbon cable), MSD module ↔ NE/monitoring module not inserted or defective
- defective control board
- defective EPROM/FEPRM
- no valid firmware loaded, display:
“_ _ _ _ _” or ERROR

- **Controller enable (without fault message)**

Motor rotates, max. 30 RPM at $n_{\text{set}} > 30$ RPM or the motor oscillates (oscillation not selected) at $n_{\text{set}} < 30$ RPM

- incorrect motor rotating field, as feeder cables interchanged (interchange 2 phase connections).
- excessively high motor encoder pulse number entered

Motor remains stationary for a speed setpoint which is not equal to zero

- oscillation function is selected (P-154, P-155=0)
- terminal 81 not selected
- function number 16 (setpoint enable) programmed but not selected

Motor briefly moves

- defective power module

Motor accelerates to a high speed

- pulse number too low

- **Positioning on**

The drive rotates with the search speed but does not position

- pulse number between two zero marks too high



Attachment

6

HS

6.1 Flow diagram for short start-up



Warning

The drive accelerates up to n_{set} , if a fault at the **NE module** is acknowledged with the MSD module enabled.

Note

If the data save operation is interrupted due to power failure or the equipment being powered-down, values which had changed since the last data save are lost, and after the drive converter is powered-up again, it outputs fault message "F-07". The parameter values can be set again after fault message "F-07" has been acknowledged (refer to Section 5.2.2).

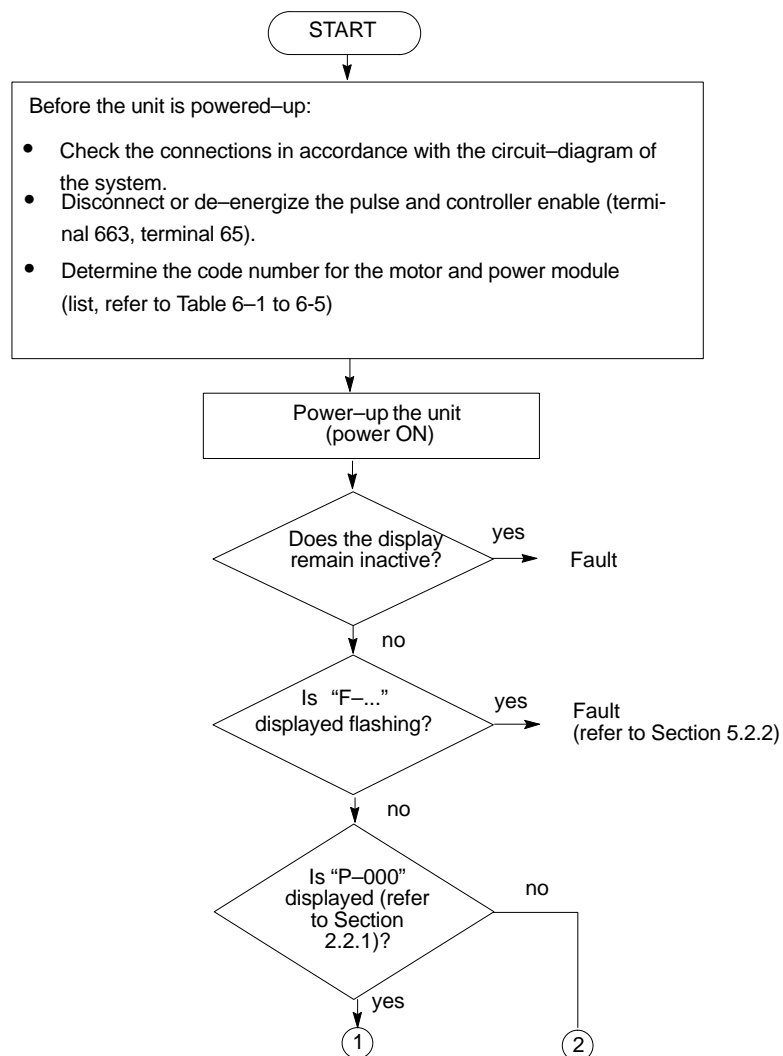

6.1 Flow diagram for short start-up

The module was already commissioned. In order to adapt it to a new motor, it must be first brought into the initialized condition.

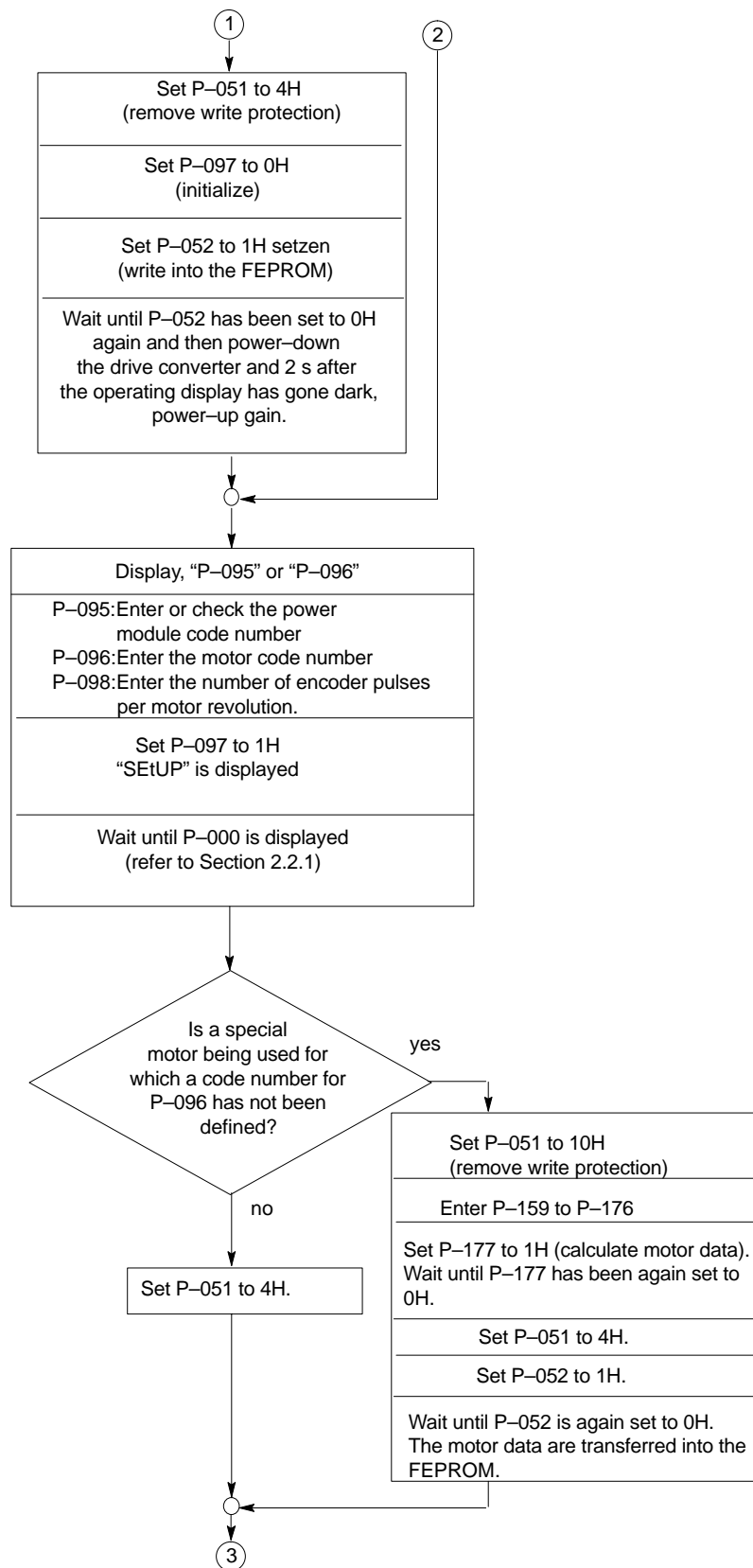

HS

6.1 Flow diagram for short start-up

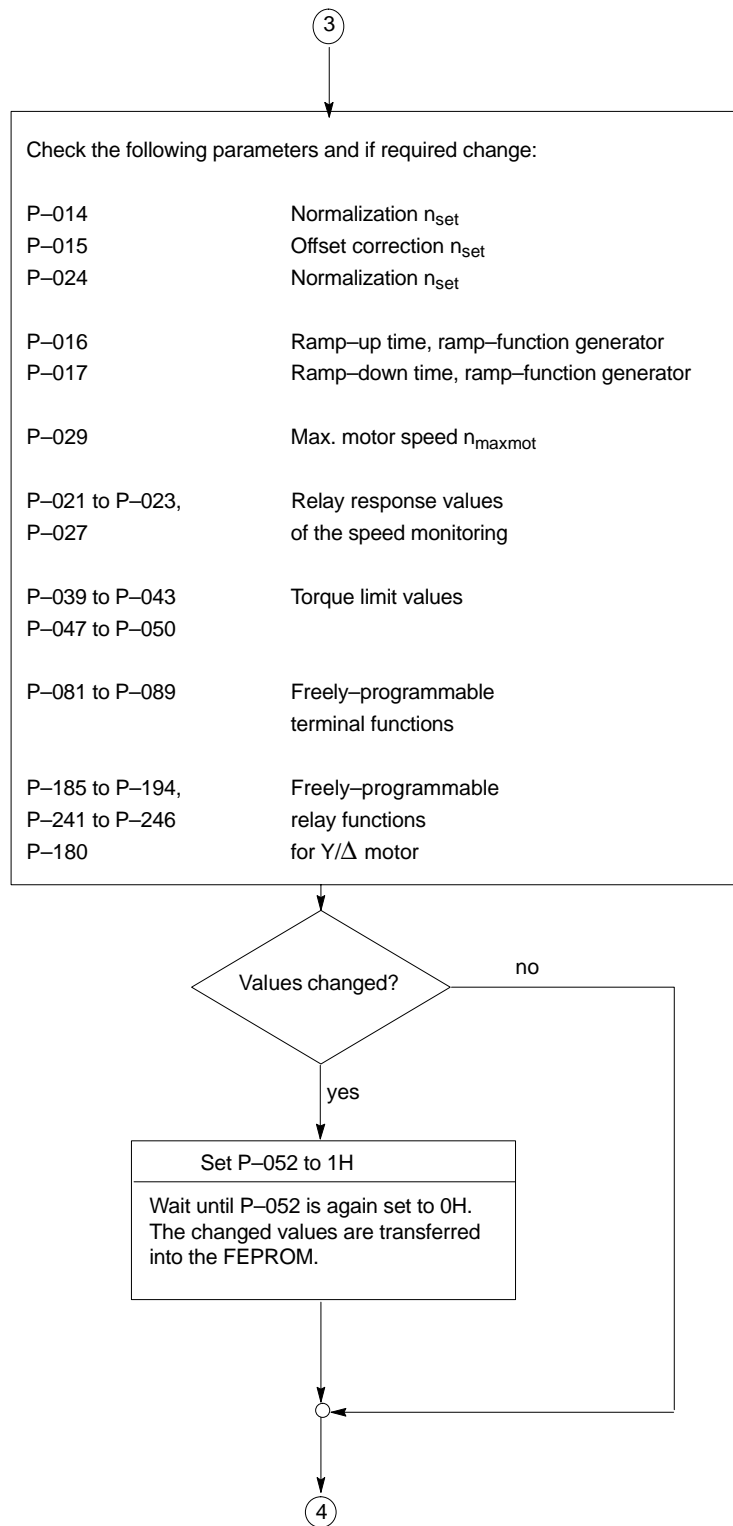

6.1 Flow diagram for short start-up

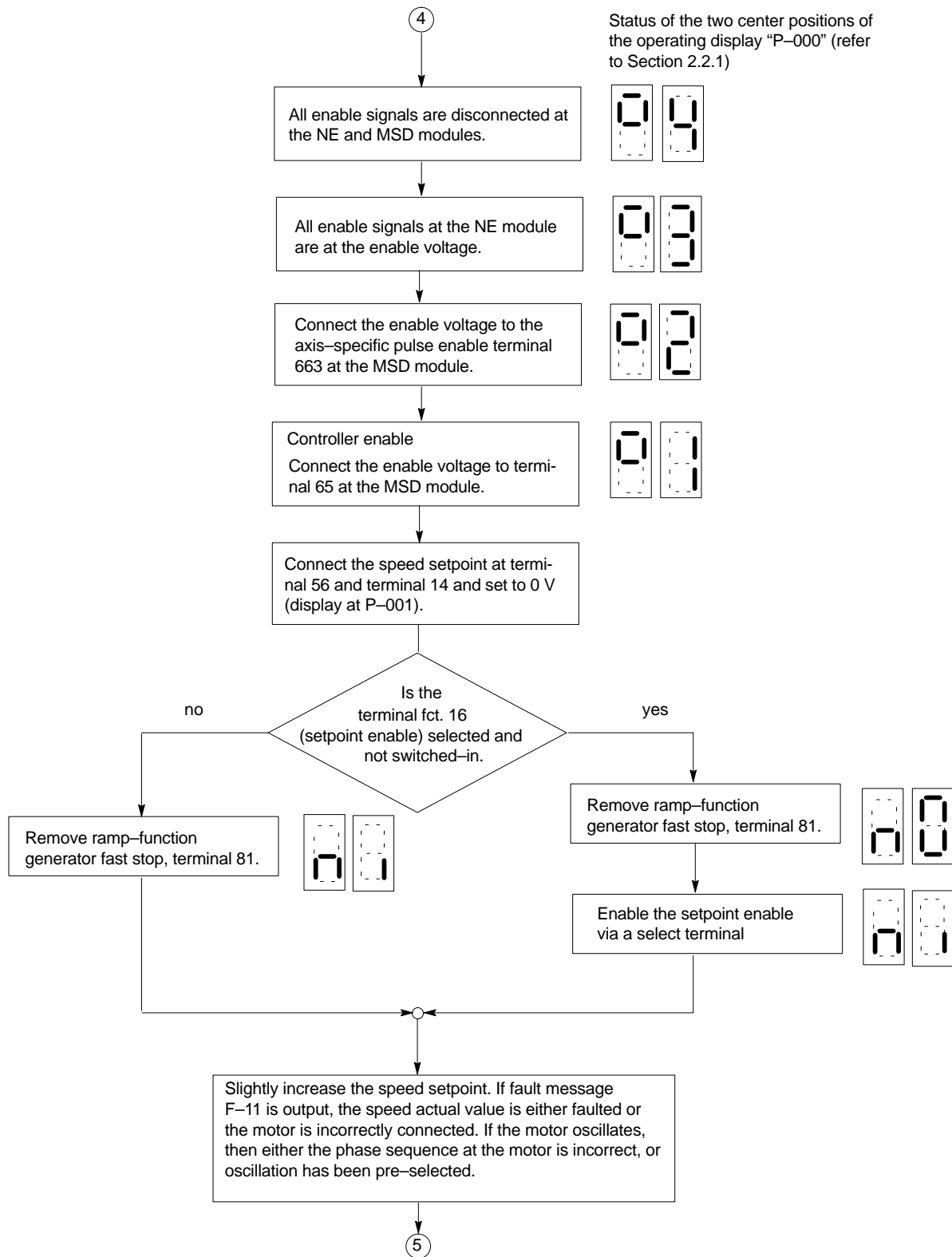

HS

6.1 Flow diagram for short start-up

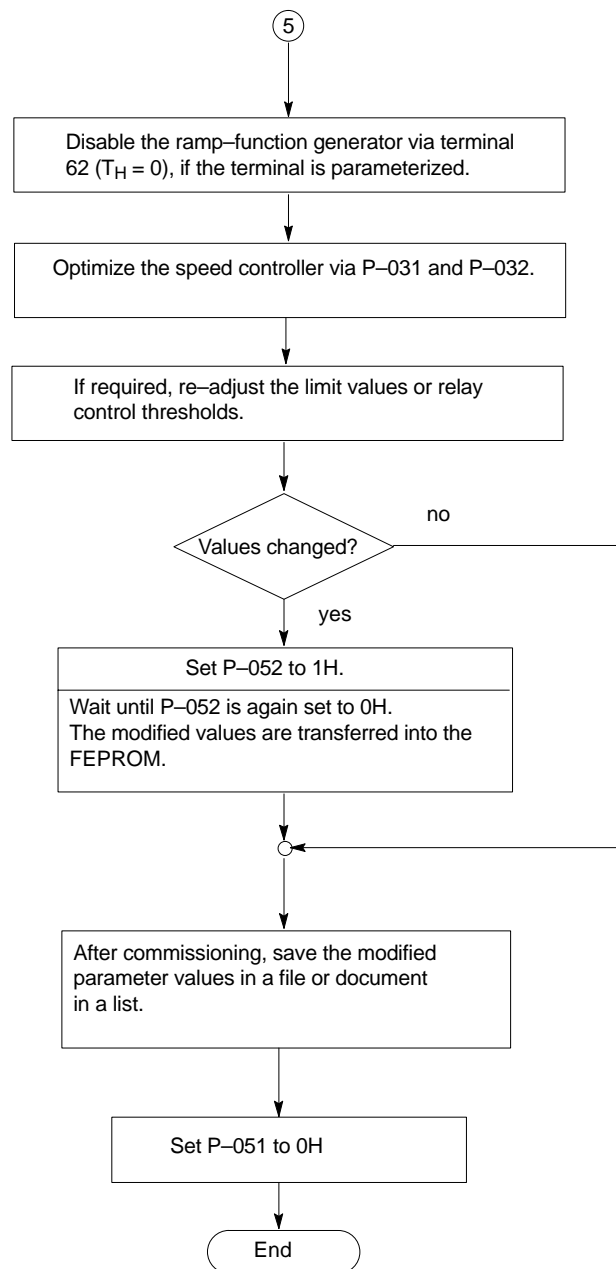

6.2 Code numbers for power modules and standard motors

Table 6-1 Power module code number

Power module type	Order No. 6SN1123-1AA0□ 6SN1124-1AA0□ 6SN1135-1BA1□	Rated output current [A]	Peak output current, briefly S6-40 % 10 min [A]	Peak output current, briefly S6-40 % 10 s [A]	Power module code No. P-095
50 A	-0CA□	24	32	32	6
80 A	-0DA□	30	40	51	7
108 A	-0LA□	45	60	76	13 FW 2.40
120 A	-0GA□	45	60	76	8
160 A	-0EA□	60	80	102	9
200 A	-0FA□	85	110	127	10
300 A	-0JA□	120	150	193	11 FW 2.00
400 A	-0KA□	200	250	257	12 FW 2.00

Table 6-2 Motor code number

Order No. [MLFB] AC motor 1PH6...	Rated motor output [kW]	Rated motor current [A]	No-load motor current [A]	Rated speed [RPM]	Max. speed [RPM]	Motor code number P-096
101-□NF4	3.7	12.5	6.2	1500	9000	101
101-□NG4	4.7	13.7	6.9	2000		102
103-□NF4	5.5	17.9	9.1	1500		103
103-□NG4	7.0	19.4	9.9	2000		104
105-□NF4	7.5	22.5	11.5	1500		105
105-□NG4	9.5	25.3	13.1	2000		106
105-□NZ4	12.0	27.0	15.6	3000		140
107-□NC4	5.0	22.7	11.7	750		131
107-□NF4	9.0	26.9	14.2	1500		107
107-□NG4	11.5	29.8	15.6	2000		108
131-□NF4	9.0	27.2	11.7	1500	8000	109
131-□NG4	12.0	32.1	13.6	2000		110
131-□NZ0	8.0	23.2	10.9	1500		141 FW 2.00
133-□NB4	4.5	26.0	9.8	525		132
133-□NF0	11.0	26.7	11.5	1500		111
133-□NF4	11.0	31.3	13.4	1500		112
133-□NG0	14.5	31.5	14.5	2000		136
133-□NG4	14.5	37.5	16.1	2000		113
135-□NF0	15.0	35.0	16.1	1500		114
135-□NF4	15.0	41.3	18.8	1500		115
135-□NG4	20.0	50.6	22.8	2000	116	
137-□NB4	7.9	43.6	18.6	525	133	
137-□NF4	18.5	50.2	22.9	1500	117	
137-□NG0	24.0	50.0	23.2	2000	137	
137-□NG4	24.0	57.8	26.5	2000	118	
137-□NZ4	11.0	41.8	18.0	750	143 FW 3.00	
138-□NF0	22.0	51.5	24.6	1500	119	
138-□NF4	22.0	61.0	28.7	1500	120	
138-□NG4	28.0	66.1	31.4	2000	121	

HS

6.2 Code numbers for power modules and standard motors

Table 6-2 Motor code number

Order No. [MLFB] AC motor 1PH6...	Rated motor output [kW]	Rated motor current [A]	No-load motor current [A]	Rated speed [RPM]	Max. speed [RPM]	Motor code number P-096
161-□NF0	22.0	53.5	23.9	1500	6500	122
161-□NF4	22.0	60.8	26.9	1500		123
161-□NG4	28.0	68.1	31.3	2000		124
163-□NB4	11.5	66.2	27.8	500		134
163-□NF0	30.0	72.5	33.3	1500		125
163-□NF4	30.0	86.0	40.3	1500		126
163-□NG4	38.0	84.0	37.5	2000		127
163-□NZ0	19.0	56.0	25.2	950		139
167-□NB4	14.5	78.0	34.4	500		135
167-□NF0	37.0	79.6	36.3	1500		128
167-□NF4	37.0	95.7	43.5	1500		129
167-□NG0	45.0	83.3	32.2	2000		138
167-□NG4	45.0	91.0	41.0	2000		130
168-□NF0	40.0	84.0	38.0	1500		142 FW 2.00
186-□NB4	26.8	66.0	35.5	610	6100	161
186-□NB9	30.8	67.0	35.0	700		167
186-□NB4	22.0	66.0	35.5	500	5000	160
186-□NE4	42.0	86.0	46.0	1250		163
186-□NF4	50.0	100.0	52.0	1500		164
206-□NB4	32.0	96.0	48.0	500		162
206-□NE4	63.0	125.0	64.0	1250		165
206-□NF4	76.0	149.0	68.0	1500		166
226-□NF4	100.0	192.0	79.0	1500		168 FW 2.00

Order No. [MLFB] AC motor 1PH7...	Rated motor output [kW]	Rated motor current [A]	No-load motor current [A]	Rated speed [RPM]	Max. speed [RPM]	Motor code number P-096
101-□NF4	3.7	8.9	4.82	1500	9000	400 FW 3.00
103-□NG4	7	16.2	7.84	2000	9000	402 FW 3.00
105-□NF4	7	16.4	8.36	1500	9000	403 FW 3.00
107-□NF4	9	20.8	9.91	1500	9000	404 FW 3.00
131-□NF4	11	23.1	8.36	1500	8000	406 FW 3.00
133-□ND4	12	28	12.7	1000	8000	408 FW 3.00
133-□NG4	20	43	17.4	2000	8000	409 FW 3.00
137-□ND4	17	40.7	18.5	1000	8000	411 FW 3.00
137-□NG4	28	58.6	21.4	2000	8000	412 FW 3.00
163-□ND4	22	52.7	24.1	1000	6500	414 FW 3.00
163-□NF4	30	70.3	30.1	1500	6500	415 FW 3.00
167-□NF4	37	77.8	31.9	1500	6500	417 FW 3.00
184-2NE□	40.0	85.0	46.2	1250	5000	418 FW 2.40
184-2NB□	22.0	54.0	34.7	500	5000	419 FW 2.40
184-□NT□	21.5	76	40	500	5000	424 FW 3.00
186-2NE□	60.0	120.0	63.0	1250	5000	420 FW 2.40
186-2NB□	29.6	75.0	42.5	500	5000	421 FW 3.00
186-□NT□	29.6	106	56	500	5000	425 FW 2.40
224-2NF□	100.0	188.0	73.0	1500	4500	422 FW 2.40
224-2NC□	55.0	117.0	63.5	700	4500	423 FW 2.40
101-□NF□	3.7	9.8	5.9	1500	9000	426 FW 3.1
103-□NG□	7	17.1	8.3	2000	9000	427 FW 3.1
105-2NF□	7	17.4	9.4	1500	9000	428 FW 3.1
107-□NF□	9	22.5	11	1500	9000	429 FW 3.1

6.2 Code numbers for power modules and standard motors

Table 6-3 Star/Delta motors

Order No. [MLFB] Y/Δ motors 1PH6...	Rated motor output [kW]	Rated motor current [A] Y/Δ	No load motor current [A] Y/Δ	Rated speed [RPM]	Max. speed [RPM]	Motor code number P-096
133-4NB8 137-4NB8	4.3 7.5	15.3/13.5 25.2/22.5	6.4/8.0 11.7/13.5	525/1250 525/1250	8000	200 202
163-4NB8 167-4NB8	11.5 14.5	39.5/35.2 45.5/40.5	14.3/20.8 17.9/23.2	500/1250 550/1250	6500	204 206
186-4NB8 206-4NB8 226-4NB8	22.0 32.0 42.0	55.0/50.0 76.0/73.0 94.0/88.0	31.0/35.0 38.0/49.0 56.0/55.0	500/1250 500/1250 500/1250	5000	208 210 214 FW 2.00

Table 6-4 Water-cooled motors

Order No. [MLFB] AC motor 1PH4...	Rated motor output [kW]	Rated motor current [A]	No load motor current [A]	Rated speed [RPM]	Max. speed [RPM]	Motor code number P-096
103-4NG6	8.5	36.4	17.7	2000	18000	301
105-4NG6	12.0	51.3	24.4	2000	17000	303
107-4NG6 133-4NF6	16.0 14.0	55.5 55.9	26.9 21.4	2000 1500	16000	305 307
135-4NF6	20.0	76.6	29.7	1500	15000	309
137-4NF6	25.0	92.8	35.9	1500	14000	311
138-4NF6	28.0	102.2	40.0	1500	13000	313
163-4ND6	25.0	103.8	42.4	1000	12000	315
167-4ND6	31.0	129.4	50.7	1000	11000	317
168-4ND6	35.0	143.9	58.6	1000	10000	319
103-4NF2 105-4NF2 107-4NF2	7.5 11.0 14.0	25.2 36.6 45.0	11.5 16.4 19.0	1500 1500 1500	9000	300 302 304
133-4NF2 135-4NF2 137-4NF2 138-4NF2	15.0 22.0 27.0 30.0	53.1 70.7 81.9 97.3	17.4 25.5 30.3 33.8	1500 1500 1500 1500	8000	306 308 310 312
163-4NF2 167-4NF2 168-4NF2	37.0 46.0 52.0	103.0 115.0 143.0	44.0 49.2 58.8	1500 1500 1500	6500	314 316 318

HS

6.2 Code numbers for power modules and standard motors

Table 6-5 Built-in motors

Order No. [MLFB] AC motor 1PH2...	Rated motor output [kW]	Rated motor current [A]	No load motor current [A]	Rated speed [RPM]	Max. speed [RPM]	Motor code number P-096
092-4WG4	4.7	20.6	10.6	2000	18000	326
096-4WG4	10.0	41.6	21.5	2000		327
123-4WF4	11.5	54.5	21.1	1500	16000	328
127-4WF4	21.0	80.8	33.4	1500		329
128-4WF4	25.0	97.1	37.4	1500		330
143-4WF4	30.0	96.5	41.8	1500	12000	331
147-4WF4	38.0	111.3	43.7	1500		332
093-6WF4	7.5	23.1	10.9	1500	10000	320
095-6WF4	10.0	28.4	13.6	1500		321
113-6WF4	15.0	53.3	21.8	1500		322
115-6WF4	16.5	52.7	21.9	1500		323
117-6WF4	18.0	58.9	24.7	1500		324
118-6WF4	23.0	78.9	32.8	1500		325
182-6WC4	11.8	37.0	17.0	750		8000
184-6WP4	14.5	56.0	25.7	600	334 FW 2.00	
186-6WB4	18.3	62.5	31.0	525	335 FW 2.00	
188-6WB4	23.6	78.0	38.0	500	6000	336 FW 2.00
254-6WB4	28.8	118.0	42.0	500		337 FW 2.00
256-6WB4	39.3	119.0	54.0	500	4000	338 FW 2.00

Measuring system pulse number is 256 or 512 depending on the toothed-wheel encoder used.

6.3 Overview of connections

Overview

- Connection diagram
- Terminals
- Relay terminals
- Star/delta changeover



Warning

Cable shields and cores in power cables which are not used (e.g. braking cores) must be connected to PE potential in order to discharge any charges occurring from capacitive coupling.

Hazardous touch voltages can occur if this is not observed.

Note: When using non-PELV circuits at terminals AS1 and AS2, the connector must be prevented from being incorrectly inserted by using the appropriate connector coding (refer to EN 60204-1, Section 6.4)
Refer to Catalog NC 60 for the coding connector Order Nos.

HS

**Connection diagram SIMODRIVE
 611 analog system**

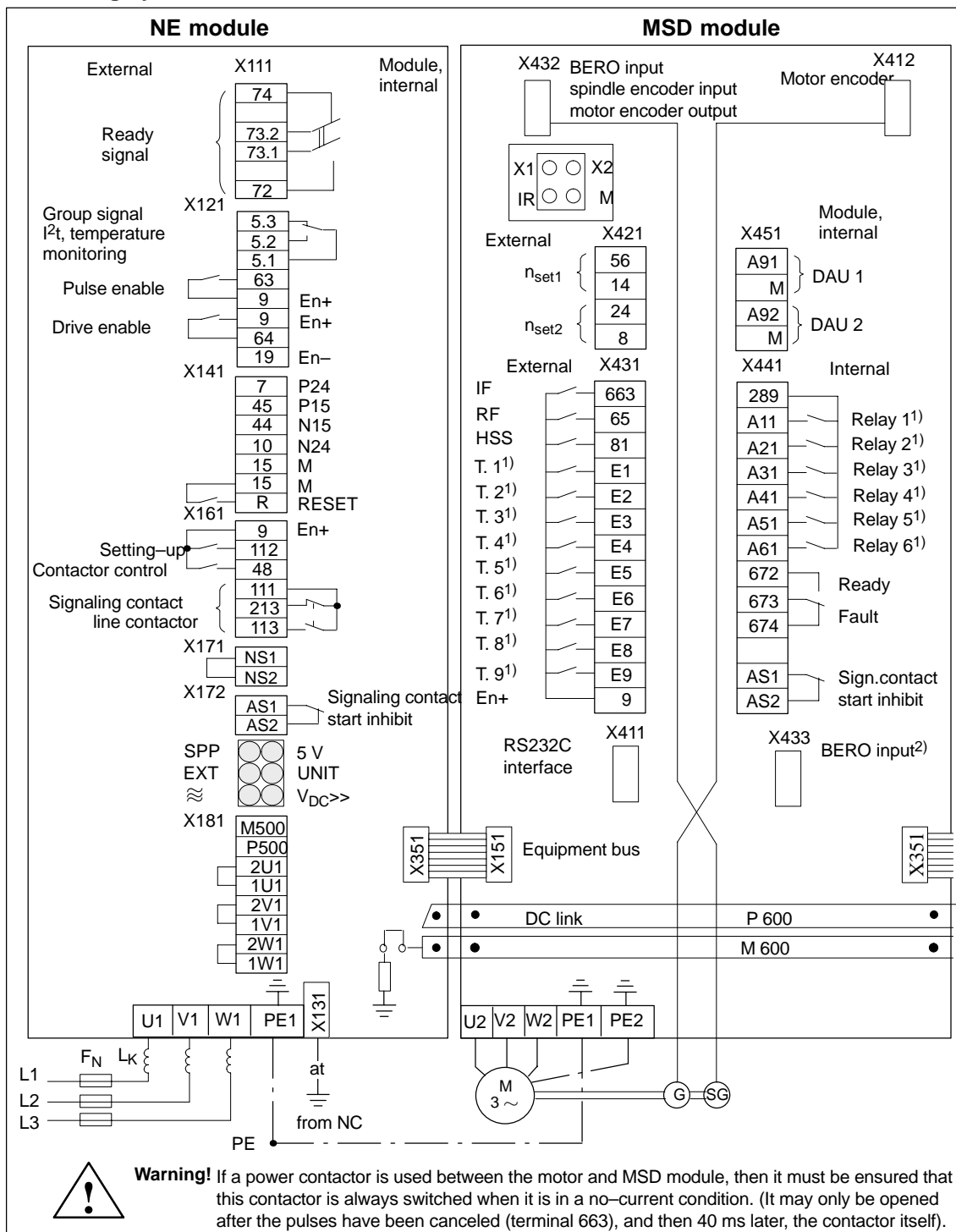

Fig. 6-1 Connection diagram

- 1) Freely-programmable inputs and outputs
- 2) From Order No. [MLFB] 6SN1121-0BA11-0AA1

Terminals

Table 6-6 Terminals

Terminal No.	Designation	Function	Type ¹⁾	Typ. voltage/limit values	Max. cross-section
U2 V2 W2		Motor connection	O	3-ph. ...450 V AC	According to the Planning Guide
PE1 PE2		Protective conductor Protective conductor	I O	0 V 0 V	Stud Stud
P600 M600		DC link DC link	I/O I/O	+300 V -300 V	Busbar Busbar
	X151/351	Equipment bus	I/O	Various	Ribbon cable
56 14 24 8	X421 X421 X421 X421	Speed setpoint 1 (differential input) Speed setpoint 2 (differential input) C axes or supplementary speed setpoint	I I I I	± 10V/0.5mA (max. ± 11 V) ± 10V/0.5mA (max. ± 11 V)	1.5 mm ² 1.5 mm ² 1.5 mm ² 1.5 mm ²
663 65 81 E1 E2 E3 E4 E5 E6 E7 E8 E9 9 ³⁾	X431 X431 X431 X431 X431 X431 X431 X431 X431 X431 X431 X431 X431	Axis-specific pulse enable Controller enable Ramp-function generator fast stop Fr.-prog. enable terminal 1 ²⁾ Fr.-prog. enable terminal 2 ²⁾ Fr.-prog. enable terminal 3 ²⁾ Fr.-prog. enable terminal 4 ²⁾ Fr.-prog. enable terminal 5 ²⁾ Fr.-prog. enable terminal 6 ²⁾ Fr.-prog. enable terminal 7 ²⁾ Fr.-prog. enable terminal 8 ²⁾ Fr.-prog. enable terminal 9 ²⁾ Enable voltage	I I I I I I I I I I I I O	+21V...+33V +13V...+30V +13V...+30V +13V...+30V +13V...+30V +13V...+30V +13V...+30V +13V...+30V +13V...+30V +13V...+30V +13V...+30V +13V...+30V +24V	1.5 mm ² 1.5 mm ² 1.5 mm ² 1.5 mm ² 1.5 mm ² 1.5 mm ² 1.5 mm ² 1.5 mm ² 1.5 mm ² 1.5 mm ² 1.5 mm ² 1.5 mm ² 1.5 mm ²
A91 M A92 M	X451 X451 X451 X451	Analog output DAU1 Ref. potential for DAU1 Analog output DAU2 Ref. potential for DAU2	O O O O	± 10 V 3 mA 0 V ± 10 V 3 mA 0 V	1.5 mm ² 1.5 mm ² 1.5 mm ² 1.5 mm ²
X1 X2 I _R M		Test socket Test socket Test socket Test socket	O O O O	0 V...5 V 3 mA 0 V...5 V 3 mA ± 10 V 3 mA 0 V	Test socket, 2 mm diameter Test socket, 2 mm diameter Test socket, 2 mm diameter Test socket, 2 mm diameter

1) I = Input, O = Output

2) Can be freely-programmed using operator control parameters

3) Refer to Sections 3.1...3.2

6.3 Overview of connections

Relay terminals

Table 6-7 Relay terminals

Terminal No.	Designation	Function	Type ¹⁾	Typ. voltage/limit values	Max. cross-section
289	X441	Signals, center contact	I	30 V/6.0 A max ³⁾	1.5 mm ²
A11	X441	Fr.-prog. relay fct. 1 ²⁾	NO	30 V/1.0 A max	1.5 mm ²
A21	X441	Fr.-prog. relay fct. 2 ²⁾	NO	30 V/1.0 A max	1.5 mm ²
A31	X441	Fr.-prog. relay fct. 3 ²⁾	NO	30 V/1.0 A max	1.5 mm ²
A41	X441	Fr.-prog. relay fct. 4 ²⁾	NO	30 V/1.0 A max	1.5 mm ²
A51 ¹⁾	X441	Fr.-prog. relay fct. 5 ²⁾	NO	30 V/1.0 A max	1.5 mm ²
A61	X441	Fr.-prog. relay fct. 6 ²⁾	NO	30 V/1.0 A max	1.5 mm ²
672	X441	} Ready/no fault, axis-specific	NO	30 V/1.0 A max	1.5 mm ²
673	X441		I	30 V/1.0 A max	1.5 mm ²
674	X441		NC	30 V/1.0 A max	1.5 mm ²
AS 1	X441	Signaling contact	I	} 250 V _{AC} /1 A, 30 V _{DC} /2 A	1.5 mm ²
AS 2	X441	Start inhibit	NC		1.5 mm ²

1) I = Input, NC = NC contact, NO = NO contact

2) Can be freely programmed using operator control parameters

3) When using several relays, the total current may not exceed 6 A.

**Star/delta
changeover**

Motors with star/delta changeover allow a wider constant power range. At lower speeds, the drive is operated in the star configuration (high torque) and at higher speeds, in the delta configuration (high stall torque). It is possible to changeover between star and delta operation while the drive is running. The changeover command (star/delta) must be externally entered (similar to a gearbox stage changeover).

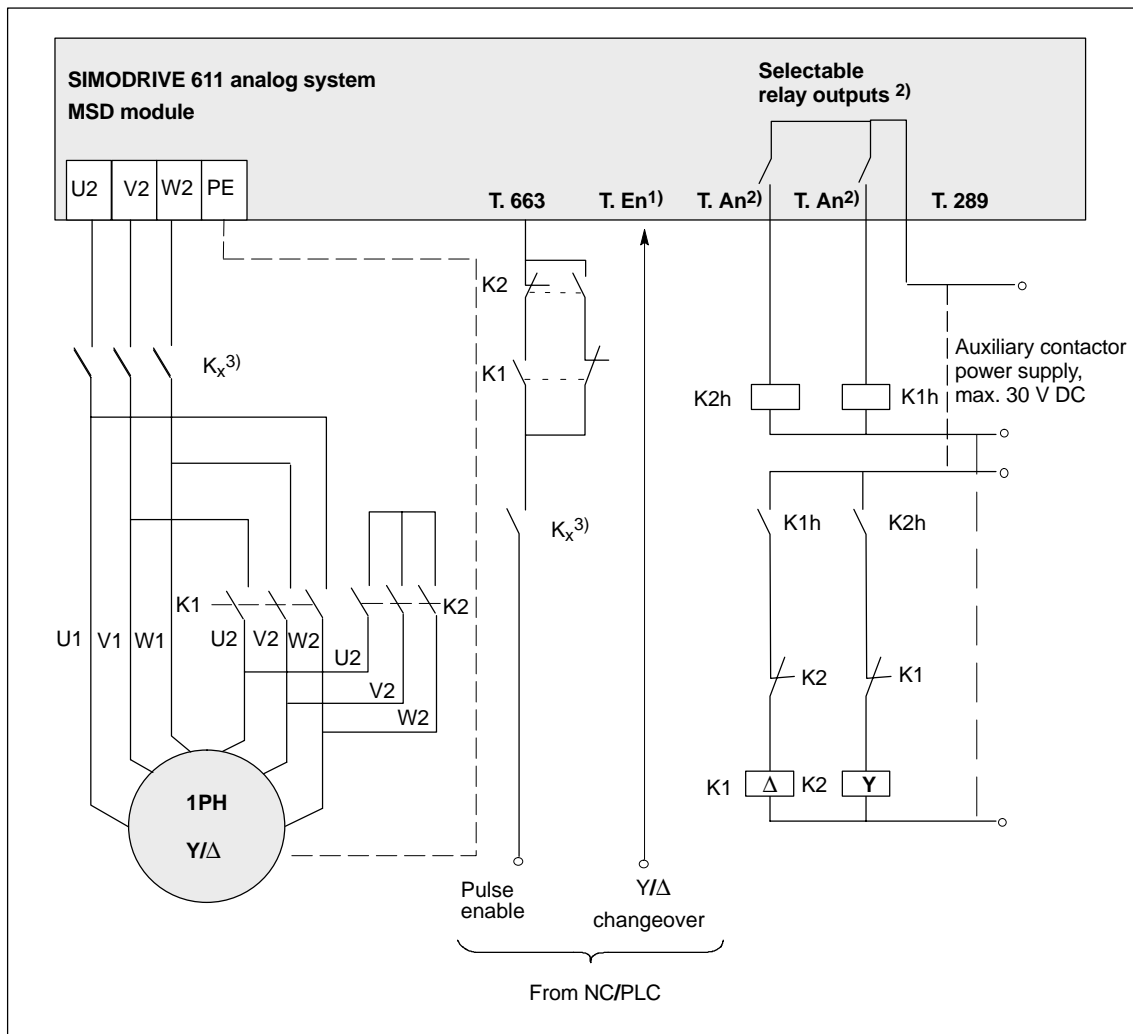

Fig. 6-2 Connection diagram for Y/Δ changeover

- 1) One input terminal, selectable from terminals E1 to E9.
- 2) Two relay outputs, selectable from terminals A11 to A61.
- 3) A safe operating stop is not guaranteed by just opening K1 and K2.
This means, for safety-related reasons, contactor K_x must provide electrical isolation.
This contactor may only be switched when it is in a no-current condition, i. e. the pulses must be inhibited 40 ms before the contactor is opened.

6.4 Connector assignments

Overview

- Connector assignment X412 and motor connector
- Connector assignment X432 for the spindle encoder
- Connector assignment X432 for the BERO
- Connector assignment X432 for motor encoder signal output for the NC

Connector assignment, X412 and motor connector

X412: 15-pin sub-D socket connector, shift latch
 Motor connector: 17-pin, round connector

Please note: The connector may only be inserted and removed when the equipment is in a no-voltage condition.

Table 6-8 Connector assignment: Encoder signals, motor

Signal name	X412/PIN No.	Motor connector/PIN No.
P encoder	1	10
M encoder	2	7
A	3	1
\bar{A}	4	2
Inner shield	5	17
B	6	11
\bar{B}	7	12
5 V sense	9	16
R	10	3
0 V sense	11	15
\bar{R}	12	13
+ Temp	14	8
- Temp	15	9

The outer shield is connected to the connector housing.

Connector assignment, X432 for the spindle encoder

15-pin sub-D plug connector: Shift latch

Please observe: The connector may only be inserted and removed when the equipment is in a no-voltage condition.

Table 6-9 Connector assignment: Evaluation for incremental encoders with TTL squarewave signals

PIN No.	Signal name	Explanation
1	5 V	Encoder power supply
2	0 V	Ground, encoder power supply
3	A	Signal A
4	\bar{A}	Signal A, inverted
5	May not be assigned	
6	B	Signal B
7	\bar{B}	Signal B, inverted
8	May not be assigned	
9	5 V sense	Sensor line
10	May not be assigned	
11	0 V sense	Sensor line, ground
12	R	Signal R
13	\bar{R}	Signal R, inverted
14	May not be assigned	
15	May not be assigned	

HS

Connector assignment, X432 for BERO**Please observe: The connector may only be inserted and removed when the equipment is in a no-voltage condition.**

Table 6-10 Connector assignment: Evaluating external reference marks

PIN No.	Signal name	Explanation
10	En +	24 V
14	BERO	Signal
15	En -	Ground

Connector assignment, X433 for BERO**Please observe: The connector may only be inserted and removed when the equipment is in a no-voltage condition.**

Table 6-11 Connector assignment: Evaluating external reference marks

PIN No.	Signal name	Explanation
1	En +	24 V
2	BERO	Signal
3	En -	Ground

6.4 Connector assignments

Connector assignment, X432 for motor encoder signal output for NC**Please observe: The connector may only be inserted and removed when the equipment is in a no-voltage condition.**

Table 6-12 Connector assignment: Motor encoder signal output with TTL squarewave signals

PIN No.	Signal name	Explanation
1		May not be assigned
2	0V	Ground, encoder power supply
3	A	Signal A
4	\bar{A}	Signal A, inverted
5		May not be assigned
6	B	Signal B
7	\bar{B}	Signal B, inverted
8		May not be assigned
9		May not be assigned
10		May not be assigned
11		May not be assigned
12	R	Signal R
13	\bar{R}	Signal R, inverted
14		May not be assigned
15		May not be assigned

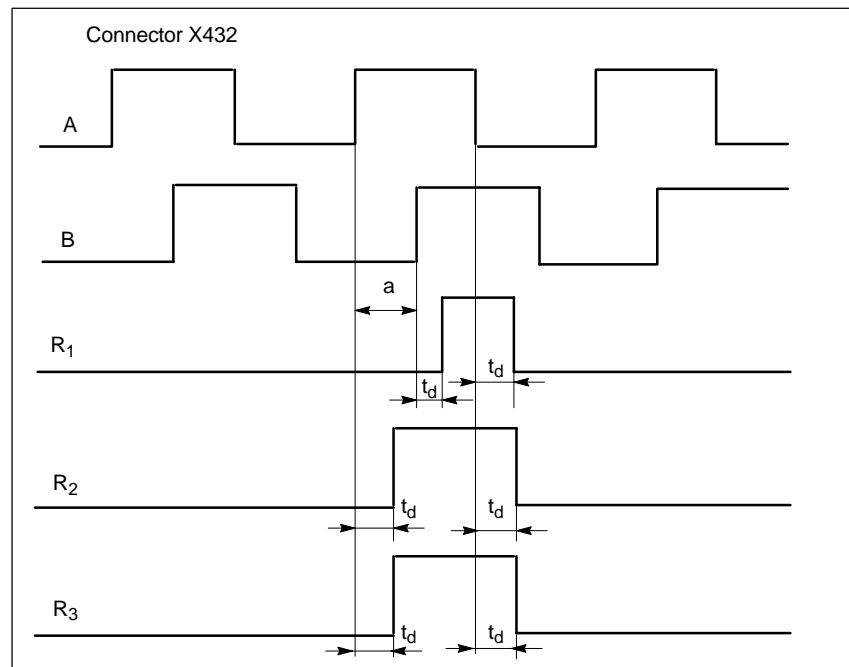

Fig. 6-3 X432: Output signals for numerical control

R₁: Multiplication factor 1 and 0.5R₂: Multiplication factor 2R₃: Multiplication factor 4

Incremental signals: TTL squarewave pulse trains A and B and their inverted pulse trains \bar{A} and \bar{B} .
 For clockwise direction of rotation, B lags A.

Edge clearance: $a \geq 200$ ns, if the maximum permissible encoder signal input frequency is not exceeded

Reference signal: One squarewave pulse R per mech. revolution and its inverted pulse \bar{R} .

Delay time: $|t_d| \geq 50$ ns

Load capacity: $-I_{a_{High}} \geq 20$ mA

$I_{a_{Low}} \geq 20$ mA

$C_{Load} \geq 1000$ pF

Signal level: Open output (internal 270 Ω) 3.5 V,
 for a total minimum terminating resistance
 60 Ω 2.5 V.

Additional details can be taken from the
 RS422A interface description.

HS

6.5 Addresses, RAM variables

The following applies for all of the address data: Segment address = 0H

Table 6-13 Addresses, RAM variables

Variable	Address high	Address low	Value	Corresponds to	Cyclic update time
Speed setpoint	0C02H	0C00H	10 0000H	n_{rated}	Speed controller clock cycle as parameterized in P-090
Speed actual value	0C06H	0C04H	10 0000H	n_{rated}	
Absolute speed actual value (1 ms)	–	1402H	1 000H	n_{rated}	
Speed, setpoint–actual value difference	0C0AH	0C08H	10 000H	n_{rated}	
Torque setpoint from the speed controller	–	0C66H	Addr. 0F52H	M_{drated}	
Torque setpoint for K/P converter	–	0C6CH	Addr. 0F52H	M_{drated}	
Actual M_{dset} for M_{d} operation	–	0C6EH	Addr. 0F52H	M_{drated}	
Input, ramp–function generator	0E00H	0E02H	10 0000H	n_{rated}	
Output, ramp–function generator	0E04H	0E06H	10 0000H	n_{rated}	
Magnetizing current setpoint	–	0F5CH	2 000H	I_{rated}	1 ms
Active current setpoint	–	0F5EH	2 000H	I_{rated}	Speed controller clock cycle as parameterized in P-090
Slip frequency setpoint	–	0F7CH	2 000H	f_{rated}	
Stator temperature	–	0FC2H	64H	100 °C	1 s
Input, digital filter	–	1B08H	Addr. 0F52H	M_{drated}	Speed controller clock cycle as parameterized in P-090
Output, digital filter	–	1B0AH	Addr. 0F52H	M_{drated}	
DC link voltage	–	906H ²⁾	3593	600 V	1 ms
Power P/P_{rated}	–	3064H	4000H	P_{rated}	1 ms
Power $ P/P_{\text{rated}} $	–	3050H ¹⁾	4000H	P_{rated}	1 ms

1) from FW 2.00
 2) up to FW 2.40

6.6 Setting and monitoring data (parameter list)



Fields with gray background: Data cannot be entered

Table 6-14 Overview of the parameters (search help for the descriptions)

P-	Section	Page	P-	Section	Page	P-	Section	Page	P-	Section	Page	P-	Section	Page
000	2.2.1	25	040	2.2.3	28	080	5.1.4	83	120	4.2	75	160	2.1	18
001	5.1.1	77	041	2.2.3	28	081	3.2.2	59	121	2.3.3	35	161	2.1	18
002	5.1.1	77	042	2.2.3	28	082	3.2.2	59	122	2.3.3	35	162	2.1	18
003	5.1.1	77	043	2.2.3	28	083	3.2.2	59	123	2.3.3	35	163	2.1	18
004	5.1.1	77	044	4.1	73	084	3.2.2	59	124	2.3.3	35	164	2.1	18
005	–	–	045	4.1	73	085	3.2.2	59	125	2.3.3	35	165	2.1	18
006	5.1.1	77	046	4.1	73	086	3.2.2	59	126	2.3.3	36	166	2.1	18
007	5.1.1	77	047	3.3.2	63	087	3.2.2	59	127	–	–	167	2.1	18
008	5.1.1	77	048	2.3.4	46	088	3.2.2	59	128	2.3.3	42	168	2.1	18
009	5.1.1	77	049	2.3.4	46	089	3.2.2	59	129	2.3.3	36	169	2.1	18
010	5.1.1	77	050	2.2.3	28	090	1.3	10	130	2.3.3	36	170	2.1	18
011	5.1.2	78	051	1.3	9	091	2.3.6	52	131	2.3.3	36	171	2.1	18
012	3.3.5	68	052	1.3	9	092	2.3.6	52	132	2.3.3	42	172	2.1	18/19
013	3.3.5	68	053	1.3	9	093	2.3.6	50	133	2.3.3	42	173	2.1	16/19
014	3.1	56	054	2.3.1	30	094	2.3.6	50	134	2.3.3	33/37	174	2.1	18
015	3.1	56	055	2.3.1	30	095	2.1	15/17	135	2.3.3	33/37	175	2.1	18/19
016	4.1	70	056	2.3.1	30	096	2.1	15/17	136	2.3.3	33/37	176	2.1	16/19
017	4.1	70	057	–	–	097	2.1	15/17	137	2.3.3	33/37	177	2.1	16/18
018	4.1	69	058	2.3.1	30	098	2.1	15/17	138	2.3.3	33/37	178	2.1	23
019	4.1	69	059	–	–	099	2.2.2	26	139	2.3.3	33/37	179	5.1.5	84
020	5.1.3	81	060	–	–	100	2.2.1	25	140	2.3.3	42	180	2.1	24
021	3.3.2	63	061	–	–	101	5.1.1	77	141	2.3.3	32/38	181	5.1.5	84
022	2.2.3	27	062	2.3.1	30	102	5.1.1	77	142	2.3.3	33/39	182	5.1.5	84
023	3.3.2	63	063	2.2.3	29	103	4.1	74	143	2.3.3	39	183	5.1.5	84
024	3.1	56	064	2.2.3	29	104	4.1	74	144	2.3.3	40	184	–	–
025	2.2.3	27	065	2.2.3	29	105	–	–	145	2.3.3	40	185	3.3.3	64
026	3.3.5	68	066	3.3.5	67	106	2.3.6	51	146	2.3.3	40	186	3.3.3	64
027	3.3.2	63	067	3.3.5	67	107	2.3.6	52	147	2.3.3	42	187	3.3.3	64
028	5.1.3	81	068	3.3.5	67	108	2.3.6	52	148	2.3.3	40	188	3.3.3	64
029	2.2.3	27	069	3.3.5	67	109	2.3.6	49	149	2.3.3	36/41	189	3.3.3	64
030	3.1	57	070	–	–	110	2.3.6	49	150	2.2.2	26	190	3.3.3	64
031	4.1	71	071	3.3.5	68	111	2.3.6	51	151	1.3	9	191	3.3.3	64
032	4.1	71	072	5.1.4	83	112	2.3.6	51	152	1.3	9	192	3.3.3	64
033	3.3.4	65	073	5.1.4	83	113	3.1	55	153	–	–	193	3.3.3	64
034	4.1	70	074	5.1.4	83	114	2.3.2	31	154	2.2.3	29	194	3.3.3	64
035	4.1	76	075	–	–	115	2.3.2	31	155	2.2.3	29	195	4.1	72
036	2.2.3	27	076	5.1.4	83	116	4.2	75	156	2.2.3	29	196	4.1	72
037	2.2.3	27	077	5.1.4	83	117	4.1	74	157	2.2.3	29	197	–	–
038	2.2.3	27	078	3.3.5	67	118	4.1	74	158	2.1	18	198	4.1	72
039	2.2.3	28	079	3.3.5	67	119	2.3.6	52	159	2.1	18	199	4.1	72

HS

6.6 Setting and monitoring data (parameter list)

Table 6-14 Overview of the parameters (search help for the descriptions), continued

P-	Section	Page	P-	Section	Page	P-	Section	Page	P-	Section	Page	P-	Section	Page
200	–	–	230	2.1	22	260	3.3.2	63	290	2.2.3	28	320	5.1.3	81
201	4.1	76	231	2.1	22	261	2.2.3	27	291	2.2.3	29	321	5.1.3	81
202	4.1	76	232	2.1	23	262	3.3.2	63	292	4.2	75	322	2.3.7	54
203	4.1	76	233	2.1	23	263	3.3.2	63	293	4.1	72	323	–	–
204	–	–	234	2.1	22	264	2.2.3	27	294	2.1	22	324	–	–
205	–	–	235	2.1	23	265	4.1	71	295	–	–	325	–	–
206	5.1.6	85	236	2.1	23	266	4.1	71	296	–	–	326	–	–
207	5.1.6	85	237	2.1	22	267	2.2.3	27	297	–	–	327	–	–
208	5.1.6	85	238	2.1	21	268	2.2.3	27	298	–	–	328	–	–
209	5.1.6	85	239	2.1	21	269	2.2.3	28	299	5.1.3	81	329	–	–
210	5.1.6	85	240	2.1	23	270	2.2.3	28	300	–	–	330	5.1.1	77
211	5.1.6	85	241	3.3.2	61	271	2.2.3	28	301	–	–	331	4.2	76
212	5.1.6	85	242	3.3.2	61	272	2.2.3	28	302	–	–	332	4.2	76
213	5.1.6	85	243	3.3.2	61	273	2.2.3	28	303	–	–	333	4.2	76
214	5.1.6	85	244	3.3.2	61	274	4.1	73	304	–	–	334	–	–
215	5.1.6	85	245	3.3.2	61	275	4.1	73	305	–	–	335	–	–
216	5.1.6	85	246	3.3.2	61	276	4.1	74	306	–	–	336	–	–
217	5.1.6	85	247	3.3.2/ 3.3.3	63/64	277	4.1	74	307	–	–	337	–	–
218	5.1.6	85	248	4.1	74	278	4.2	75	308	–	–	338	–	–
219	2.1	22	249	2.3.5	48	279	–	–	309	–	–	339	–	–
220	2.1	22	250	2.3.5	48	280	4.1	74	310	–	–	340	2.3.4	47
221	2.1	22	251	2.3.5	48	281	4.1	74	311	5.1.7	86	341	2.3.4	47
222	2.1	22	252	–	–	282	–	–	312	5.1.7	86	342		
223	2.1	22	253	–	–	283	4.1	72	313	5.1.7	86	343	2.3.4	47
224	2.1	22	254	5.1.2	79	284	4.1	72	314	–	–	344	2.3.4	47
225	2.1	22	255	5.1.2	80	285	4.1	72	315	–	–	345	2.3.4	47
226	2.1	22	256	3.3.2	63	286	4.1	72	316	4.2	75	346	2.3.4	47
227	2.1	22	257	3.3.2	63	287	–	–	317	2.3.7	54	347	2.3.4	47
228	2.1	22	258	3.1	56	288	4.1	72	318	2.3.7	54	348	–	–
229	2.1	22	259	–	–	289	4.1	72	319	2.3.7	54	349	–	–

P No.	Designation	Sec.	Firm-ware-rel.	Setting range	Default	Dim.	Setting value, dependent on the gearbox stage							
							1	2	3	4	5	6	7	8
(P-000)	Operating display	2.2.1	1.20	–	–	–								
(P-001)	Speed setpoint	5.1.1	1.20	–	–	RPM								
(P-002)	Speed actual value	5.1.1	1.20	–	–	RPM								
(P-003)	Motor voltage	5.1.1	1.20	–	–	V								
(P-004)	Utilization	5.1.1	1.20	–	–	%								
(P-006)	DC link voltage	5.1.1	1.20	–	–	V								
(P-007)	Motor current	5.1.1	1.20	–	–	A								
(P-008)	Motor reactive power	5.1.1	1.20	–	–	kVA								
(P-009)	Motor active power	5.1.1	1.20	–	–	kW								
(P-010)	Motor temperature	5.1.1	1.20	–	–	°C								
(P-011)	Status of the digital inputs	5.1.2	1.20	–	–	Hex								
P-012	Normalization, DAU n_{act} display	3.3.5	1.20	–200,0...200,0	100,0	%								
P-013	Normalization, utilization display	3.3.5	1.20	–200,0...200,0	100,0	%								
P-014	Speed for max. motor useful speed mot 1	3.1	1.20	$-n_{maxMot} \dots n_{maxMot}$	n_{maxMot}	RPM								
P-015	Offset correction, speed setpoint	3.1	1.20	C000...4000	0	Hex								
P-016	Ramp-up time, ramp-function generator	4.1	1.20	0,01...64,00	2,00	s								
P-017	Ramp-down time, ramp-function generator	4.1	1.20	0,01...64,00	2,00	s								
P-018	Smoothing time, speed setpoint smoothing	4.1	2.40	3...10000	5	ms								
P-019	Degree of rounding-off, speed setpoint	4.1	1.20	0...30	0	Dec								
(P-020)	Diagnostics, speed actual value	5.1.3	1.20	–	–	Hex								
P-021	n_{min} for " $n_{act} < n_{min}$ " signal mot 1	3.3.2	1.20	0... n_{rated}	12	RPM								
P-022	Shutdown speed, pulse cancellation mot 1	2.2.3	1.20	1... n_{rated}	$n_{rated}/256$	RPM								
P-023	n_x for " $n_{act} < n_x$ " signal mot 1	3.3.2	1.20	0... n_{maxMot}	6000	RPM								
P-024	Normalization, setpoint	3.1	1.20	5,0...15,0	10,0	V								
P-025	Timer stage, pulse cancellation	2.2.3	3.00	0...15000	0	ms								
P-026	Normalization DAU M/M_{rated}	3.3.5	1.20	–200,0...200,0	100,0	%								
P-027	Tolerance bandwidth for " $n_{act} = n_{set}$ " signal mot 1	3.3.2	1.20	0... $n_{rated}/16$	20	RPM								
(P-028)	Diagnostics	5.1.3	1.20	–	–	Hex								
P-029	Speed limiting	2.2.3	1.20	0... n_{maxMot}	n_{maxMot}	RPM								

P No.	Designation	Sec.	Firm-ware-rel.	Setting range	Default	Dim.	Setting value, dependent on the gearbox stage									
							1	2	3	4	5	6	7	8		
P-030	Steady-state minimum speed	3.1	2.00	0...n _{maxMot}	0	RPM										
P-031	P gain, speed controller	mot 1	4.1	3,0...120,0 6.0 ... 240.0 from FW3.1	32,0	Dec										
P-032	Integral action time, speed controller	mot 1	4.1	5...6000	20	ms										
P-033	Encoder resolution for NC	3.3.4	1.20	0...7	0	Dec										
P-034	Smoothing time, speed actual value smoothing	4.1	3.00	0...10	3	ms										
P-035	Smoothing time, torque setpoint	mot 1	4.1	3...1000	3	ms										
P-036	Encoder phase error correction	2.2.3	1.20	-400...400	0	Dec										
P-037	Changeover speed, motor encoder eval.	mot 1	2.2.3	32000	32000	RPM										
P-038	Hysteresis, P-037	mot 1	2.2.3	0...500	50	RPM										
P-039	1st torque limit value	mot 1	2.2.3	5...300	100	%										
P-040	Regenerative limiting	mot 1	2.2.3	5...100	100	%										
P-041	2nd torque limit	mot 1	2.2.3	5...100	50	%										
P-042	Changeover speed for P-040	mot 1	2.2.3	1...n _{maxMot}	500	RPM										
P-043	Hysteresis, P-042	mot 1	2.2.3	0...n _{maxMot}	20	RPM										
P-044	Select torque setpoint smoothing	4.1	1.20	0...1	1	Hex										
P-045	Switch-in speed, torque setpoint smooth.	mot 1	4.1	1...n _{maxMot}	4000	RPM										
P-046	Hysteresis, P-045	mot 1	4.1	0...n _{rated}	50	RPM										
P-047	M _{dx} for "M _d < M _{dx} " signal	mot 1	3.3.2	0...100	90	%										
P-048	Normalization, torque setpoint	2.3.4	1.20	-250...250	100	%										
P-049	Offset, torque setpoint	2.3.4	1.20	C000...4000	0	Hex										
P-050	Switching speed from M _{d1} to M _{d2}	mot 1	2.2.3	0...n _{maxMot}	4· n _{rated}	RPM										
P-051	Write protection	1.3	1.20	0...7FFF	0	Hex										
P-052	Transfer parameter into FEPR0M	1.3	1.20	0...1	0	Hex										
P-053	Control word	1.3	2.40	0...FFFF	11	Hex										
P-054	M19 normalization, speed setpoint	2.3.1	1.20	-n _{maxMot} ... n _{maxMot}	n _{rated}	RPM										
P-055	M19 offset correction, speed setpoint	2.3.1	1.20	C000...4000	0	Hex										
P-056	M19 changeover speed	2.3.1	1.20	0...n _{maxMot}	n _{rated}	RPM										
P-058	Shutdown threshold, rounding-off M19	2.3.1	2.00	0...n _{maxMot}	0	RPM										
P-062	M19 switching threshold I comp. speed controller	2.3.1	1.20	0...n _{maxMot}	n _{rated} /128	RPM										

P No.	Designation	Sec.	Firm-ware rel.	Setting range	Default	Dim.	Setting value, dependent on the gearbox stage										
							1	2	3	4	5	6	7	8			
P-063	Max. motor temperature	mot 1	2.2.3	1.20	0...170	Motor type dep.	° C										
P-064	Fixed temperature		2.2.3	1.20	0...170	0	° C										
P-065	Timer stage, motor temperature alarm		2.2.3	1.20	0...600	240	s										
P-066	Address DAU 1		3.3.5	1.20	0...FFFF	3044	Hex										
P-067	Shift factor DAU 1		3.3.5	1.20	0...15	0	Dec										
P-068	Address DAU 2		3.3.5	1.20	0...FFFF	3048	Hex										
P-069	Shift factor DAU 2		3.3.5	1.20	0...15	0	Dec										
P-071	Smoothing time DAU utilization display		3.3.5	2.40	0...32767	20	ms										
P-072	Address DAU 4		5.1.4	1.20	0...FFFF	C04	Hex										
P-073	Shft factor DAU 4		5.1.4	1.20	0...15	0	Dec										
P-074	Offset DAU 4		5.1.4	1.20	7F...FF80	0	Hex										
P-076	Address DAU 3		5.1.4	1.20	0...FFFF	3050	Hex										
P-077	Shift factor DAU 3		5.1.4	1.20	0...15	0	Dec										
P-078	Offset DAU 1		3.3.5	1.20	7F...FF80	0	Hex										
P-079	Offset DAU 2		3.3.5	1.20	7F...FF80	0	Hex										
P-080	Offset DAU 3		5.1.4	1.20	7F...FF80	0	Hex										
P-081	Terminal function assignment E1		3.2.2	1.20	1...34	1	Dec										
P-082	Terminal function assignment E2		3.2.2	1.20	1...34	7	Dec										
P-083	Terminal function assignment E3		3.2.2	1.20	1...34	3	Dec										
P-084	Terminal function assignment E4		3.2.2	1.20	1...34	6	Dec										
P-085	Terminal function assignment E5		3.2.2	1.20	1...34	4	Dec										
P-086	Terminal function assignment E6		3.2.2	1.20	1...34	2	Dec										
P-087	Terminal function assignment E7		3.2.2	1.20	1...34	9	Dec										
P-088	Terminal function assignment E8		3.2.2	1.20	1...34	10	Dec										
P-089	Terminal function assignment E9		3.2.2	1.20	1...34	11	Dec										
P-090	Control word		1.3	1.20	0...FFFF	002D	Hex										
P-091	Frequency filter 1 HPC		2.3.6	2.00	45...750	300	Hz										
P-092	Quality filter 1 HPC		2.3.6	2.00	0,50...10,00	1,00	Dec										

P No.	Designation	Sec.	Firm- ware rel.	Setting range	Default	Dim.	Setting value, dependent on the gearbox stage							
							1	2	3	4	5	6	7	8
P-093	Offset correction, speed setpoint HPC	2.3.6	2.00	C000...4000	0	Hex								
P-094	Normalization, speed setpoint HPC	2.3.6	2.00	$-n_{rated}^{-1} \dots +n_{rated}^{-1}$	n_{rated}^8	RPM								
P-095	Power module code number	2.1	1.20	6...13	7	Dec								
P-096	Motor code number mot 1	2.1	1.20	101...425	101	Dec								
P-097	Initialization	2.1	1.20	0...1	0	Hex								
P-098	Encoder pulse number, motor meas. system	2.1	1.20	128...4096	2048	Dec								
(P-099)	Firmware release	2.2.2	1.20	0.00...99.00	-	Dec								
(P-100)	Operating display	2.2.1	1.20	-	-	-								
(P-101)	Setpoint for torque-controlled operation	5.1.1	1.20	-	-	%								
(P-102)	Speed actual value	5.1.1	1.20	-	-	RPM								
P-103	Frequency, torque setpoint filter mot 1	4.1	1.20	50...450	300	Hz								
P-104	Quality, torque setpoint filter mot 1	4.1	1.20	0,10...10,00	1,00	Dec								
P-106	Smoothing time, speed setpoint smooth. HPC	2.3.6	2.00	3...10000	3	ms								
P-107	Frequency filter 2 HPC	2.3.6	2.00	45...750	300	Hz								
P-108	Quality filter 2 HPC	2.3.6	2.00	0,50...10,00	1,00	Dec								
P-109	Torque limit value HPC	2.3.6	2.00	5...180	100	%								
P-110	Regenerative limiting HPC	2.3.6	2.00	5...100	100	%								
P-111	P gain speed controller HPC	2.3.6	2.00	3,0...240,0	10,0	Dec								
P-112	Integral action time, speed controller HPC	2.3.6	2.00	2...6000	20	ms								
P-113	channel selection speed setpoint	3.1	1.20	0...3	1	Hex								
P-114	Normalization speed setpoint C axis	2.3.2	1.20	$-n_{rated}^{-1} \dots +n_{rated}^{-1}$	n_{rated}^8	RPM								
P-115	Offset correction speed setpoint C axis	2.3.2	1.20	C000...4000	0	Hex								
P-116	Correction, P gain current controller mot 1	4.2	1.20	-255...255	0	Dec								
P-117	Select torque setpoint filter mot 1	4.1	1.20	0...FFFF	0	Hex								
P-118	Type, torque setpoint filter mot 1	4.1	1.20	0...FFFF	0	Hex								
P-119	Flux adaptation HPC	2.3.6	2.00	5...100	100	%								
P-120	Changeover speed, curr.controller adapt.Mot 1	4.2	1.20	500...10000	Mot.type dep	RPM								

P No.	Designation	Sec.	Firm-ware rel.	Setting range	Default	Dim.	Setting value, dependent on the gearbox stage							
							1	2	3	4	5	6	7	8
P-121	Position reference value 1	2.3.3	1.20	0...64000	0	Dec								
P-122	Position reference value 2	2.3.3	1.20	0...64000	0	Dec								
P-123	Position reference value, incremental	2.3.3	1.20	-32768...32767	256	Dec								
P-124	Position reference value 3	2.3.3	1.20	0...64000	0	Dec								
P-125	Position reference value 4	2.3.3	1.20	0...64000	0	Dec								
P-126	Bandwidth integrator enable speed controller	2.3.3	1.20	0,0...180,0	10,0	Dec								
(P-128)	Actual position reference value	2.3.3	1.20	-	-	Dec								
P-129	Set the internal zero mark	2.3.3	1.20	0...1	0	Hex								
P-130	Zero mark offset	2.3.3	1.20	0...64000	0	Dec								
P-131	Max. pulse number between 2 zero marks	2.3.3	1.20	128...64000	2048	Dec								
(P-132)	Absolute position act. value w/o zero mark shift	2.3.3	1.20	-	-	Dec								
(P-133)	Difference between 2 ext. zero marks	2.3.3	1.20	-	-	Dec								
P-134	Application point for P-136	2.3.3	1.20	0,0...180,0	10,0	Degree								
P-135	Application point for P-137/P-138	2.3.3	1.20	0,0...180,0	2,0	Degree								
P-136	P gain, straight line 1	2.3.3	1.20	0...FFFF	220	Hex								
P-137	P gain, straight line 2	2.3.3	1.20	0...FFFF	220	Hex								
P-138	P gain, straight line 2 (HMS)	2.3.3	1.20	0...FFFF	44	Hex								
P-139	Multiplier for braking parabola	2.3.3	1.20	0...FFFF	100	Hex								
(P-140)	Abs. position act. value w/ zero mark shift	2.3.3	1.20	-	-	Dec								
P-141	Switching parameter, positioning	2.3.3	1.20	0...FFFF	0	Hex								
P-142	Flag for speed increase	2.3.3	1.20	0...21	0	Hex								
P-143	Transfer parameter P-141	2.3.3	1.20	0...1	0	Hex								
P-144	Response width, relay 1	2.3.3	1.20	0,00...18,00	1,00	Degree								
P-145	Response width, relay 2	2.3.3	1.20	0,00...18,00	5,00	Degree								
P-146	Search speed for spindle positioning	2.3.3	1.20	0...4 · n _{rated}	500	RPM								
(P-147)	Position counter status re: BERO	2.3.3	1.20	-	-	Dec								
P-148	Motion window spindle positioning	2.3.3	1.20	0,0...180,0	1,0	Degree								

P No.	Designation	Sec.	Firm-ware rel.	Setting range	Default	Dim.	Setting value, dependent on the gearbox stage							
							1	2	3	4	5	6	7	8
P-149	Start-up parameter C axis/position	2.3	1.20	0...FFFF	40	Hex								
(P-150)	Board ID	2.2.2	1.20	Dependent on the module expansion		Hex								
P-151	Write protection	1.3	1.20	0...7FFF	0	Hex								
P-152	Transfer parameter into EEPROM	1.3	1.20	0...1	0	Hex								
P-154	Oscillation setpoint 1	2.2.3	1.20	-n _{maxMot} ... n _{maxMot}	0	RPM								
P-155	Oscillation setpoint 2	2.2.3	1.20	-n _{maxMot} ... n _{maxMot}	0	RPM								
P-156	Oscillation interval time 1	2.2.3	1.20	10...10000	1000	ms								
P-157	Oscillation interval time 2	2.2.3	1.20	0...10000	1000	ms								
P-158	Inductance of the series reactor	mot 1	2.1	3.00	0,000...65,535	0,000	mH							
P-159	Motor moment of inertia	mot 1	2.1	1.20	0,002...32,000	Mot.type dep.	kgm ²							
P-160	Rated motor power	mot 1	2.1	1.20	0,0...150,0	Mot.type dep.	kW							
P-161	Rated motor current	mot 1	2.1	1.20	0,00...200,0	Mot.type dep.	A							
P-162	Rated motor voltage	mot 1	2.1	1.20	0,0...500,0	Mot.type dep.	V							
P-163	Rated motor speed	mot 1	2.1	1.20	0...4096	Mot.type dep.	RPM							
P-164	Rated motor frequency	mot 1	2.1	1.20	0,0...409,6	Mot.type dep.	Hz							
P-165	No-load motor voltage	mot 1	2.1	1.20	0,0...500,0	Mot.type dep.	V							
P-166	No-load motor current	mot 1	2.1	1.20	0,00...200,00	Mot.type dep.	A							
P-167	Stator resistance, cold	mot 1	2.1	1.20	0...32767	Mot.type dep.	mΩ							
P-168	Rotor resistance, cold	mot 1	2.1	1.20	0...32767	Mot.type dep.	mΩ							
P-169	Stator leakage reactance	mot 1	2.1	1.20	0...32767	Mot.type dep.	mΩ							
P-170	Rotor leakage reactance	mot 1	2.1	1.20	0...32767	Mot.type dep.	mΩ							
P-171	Magnetizing reactance	mot 1	2.1	1.20	0...65535	Mot.type dep.	mΩ							
P-172	Upper speed L _h characteristic	mot 1	2.1	1.20	100...24000	Mot.type dep.	RPM							
P-173	Speed at the start of field weakening	mot 1	2.1	1.20	100...6000	Mot.type dep.	RPM							
P-174	Max. motor speed	mot 1	2.1	1.20	0...20000	Mot.type dep.	RPM							
P-175	Gain factor L _h characteristic	mot 1	2.1	1.20	50...300	Mot.type dep.	%							
P-176	Stall torque reduction factor	mot 1	2.1	1.20	50...150	Mot.type dep.	%							
P-177	Start calculation motor 1 (P-096)	2.1	1.20	0...1	0	Hex								
(P-178)	Speed at the start of the stall torque	mot 1	2.1.3	3.1	0...32767	Mot.type dep.	rev/min							

P No.	Designation	Sec.	Firm-ware rel.	Setting range	Default	Dim.	Setting value, dependent on the gearbox stage							
							1	2	3	4	5	6	7	8
P-179	Select min/max memory	5.1.5	1.20	0...2	0	Hex								
P-180	Enable motor changeover (star/delta)	2.1.3	1.20	0...1	0	Hex								
P-181	Address for min/max memory	5.1.5	1.20	0...FFFF	0	Hex								
(P-182)	Min. value, min/max memory	5.1.5	1.20	–	–	Hex								
(P-183)	Max. value, min/max memory	5.1.5	1.20	–	–	Hex								
P-185	Address for monitoring 1	3.3.3	1.20	0...FFFF	C06	Hex								
P-186	Threshold for monitoring 1	3.3.3	1.20	0...FFFF	0	Hex								
P-187	Pull-in delay, monitoring 1	3.3.3	1.20	0,00...10,00	0,00	s								
P-188	Drop-out delay, monitoring 1	3.3.3	1.20	0,00...10,00	0,00	s								
P-189	Hysteresis, monitoring 1	3.3.3	1.20	0...FFFF	1	Hex								
P-190	Address for monitoring 2	3.3.3	1.20	0...FFFF	C06	Hex								
P-191	Threshold for monitoring 2	3.3.3	1.20	0...FFFF	0	Hex								
P-192	Pull-in delay for monitoring 2	3.3.3	1.20	0,00...10,00	0,00	s								
P-193	Drop-out delay, monitoring 2	3.3.3	1.20	0,00...10,00	0,00	s								
P-194	Hysteresis, monitoring 2	3.3.3	1.20	0...FFFF	1	Hex								
P-195	Lower adaptation speed	mot 1	4.1	1.20	0...n _{maxMot}	1000	RPM							
P-196	Upper adaptation speed	mot 1	4.1	1.20	0...n _{maxMot}	1200	RPM							
P-198	P gain, upper adaptation speed	mot 1	4.1	1.20	1,0...120,0 6,0...240,0 fr.FW3.1	24,0	Dec							
P-199	Reduction factor, P gain	mot 1	4.1	1.20	1...200	100	%							
P-201	Integr.act.time, upper adaptation speed	mot 1	4.1	1.20	5...6000	80	ms							
P-202	Reduction factor, integral action time	mot 1	4.1	1.20	1...200	100	%							
P-203	Control word, speed controller adapt.	mot 1	4.1	1.20	0...7	0	Dec							
P-206	Select transient recorder	5.1.6	1.20	0...1	0	Hex								
P-207	Set transient recorder	5.1.6	1.20	0...10	1	Hex								
P-208	Address for start condition	5.1.6	1.20	0...FFFF	0	Hex								
P-209	Threshold for start condition	5.1.6	1.20	0...FFFF	0	Hex								
P-210	Address for stop condition	5.1.6	1.20	0...FFFF	0	Hex								

P No.	Designation	Sec.	Firm-ware rel.	Setting range	Default	Dim.	Setting value, dependent on the gearbox stage							
							1	2	3	4	5	6	7	8
P-211	Threshold for stop condition	5.1.6	1.20	0...FFFF	0	Hex								
P-212	Address, signal 1	5.1.6	1.20	0...FFFF	0	Hex								
P-213	Address, signal 2	5.1.6	1.20	0...FFFF	0	Hex								
P-214	Start trace record output	5.1.6	1.20	0...1	0	Hex								
P-215	Shift factor, signal 1	5.1.6	1.20	0...15	0	Dec								
P-216	Shift factor, signal 2	5.1.6	1.20	0...15	0	Dec								
P-217	Trigger signal 1	5.1.6	1.20	0...FFFF	0	Hex								
P-218	Trigger signal 2	5.1.6	1.20	0...FFFF	0	Hex								
P-219	Motor moment of inertia	mot 2	2.1.3	1.20	0,002...32,000	Mot.type dep.	kgm ²							
P-220	Rated motor output	mot 2	2.1.3	1.20	0,0...150	Mot.type dep.	kW							
P-221	Rated motor current	mot 2	2.1.3	1.20	0,00...200,00	Mot.type dep.	A							
P-222	Rated motor voltage	mot 2	2.1.3	1.20	0,0...500,0	Mot.type dep.	V							
P-223	Rated motor speed	mot 2	2.1.3	1.20	0...4096	Mot.type dep.	RPM							
P-224	Rated motor frequency	mot 2	2.1.3	1.20	0,0...409,6	Mot.type dep.	Hz							
P-225	No-load motor voltage	mot 2	2.1.3	1.20	0,0...500,0	Mot.type dep.	V							
P-226	No-load motor current	mot 2	2.1.3	1.20	0,00...200,00	Mot.type dep.	A							
P-227	Stator resistance, cold	mot 2	2.1.3	1.20	0...32767	Mot.type dep.	mΩ							
P-228	Rotor resistance, cold	mot 2	2.1.3	1.20	0...32767	Mot.type dep.	mΩ							
P-229	Stator leakage reactance	mot 2	2.1.3	1.20	0...32767	Mot.type dep.	mΩ							
P-230	Rotor leakage reactance	mot 2	2.1.3	1.20	0...32767	Mot.type dep.	mΩ							
P-231	Magnetizing reactance	mot 2	2.1.3	1.20	0...65535	Mot.type dep.	mΩ							
P-232	Upper speed L _H characteristic	mot 2	2.1.3	1.20	100...24000	Mot.type dep.	RPM							
P-233	Speed at the start of field weak.	mot 2	2.1.3	1.20	100...6000	Mot.type dep.	RPM							
P-234	Max. motor speed	mot 2	2.1.3	1.20	0...20000	Mot.type dep.	RPM							
P-235	Gain factor L _H characteristic	mot 2	2.1.3	1.20	50...300	Mot.type dep.	%							
P-236	Stall torque reduction factor	mot 2	2.1.3	1.20	50...150	Mot.type dep.	%							
P-237	Start calculation, third-party mot.		2.1.3	1.20	0...1	0	Hex							
P-238	Motor code number	mot 2	2.1.3	1.20	101...425	101	Dec							

P No.	Designation	Sec.	Firm-ware rel.	Setting range	Default	Dim.	Setting value, dependent on the gearbox stage							
							1	2	3	4	5	6	7	8
P-239	Start calculation, motor 2 (P-238)	2.1.3	1.20	0...1	0	Dec								
(P-240)	Speed at the start of the stall torque mot 2	2.1.3	3.1	0...32767		rev/min								
P-241	Programmable signal 1	3.3.2	1.20	1...20	2	Dec								
P-242	Programmable signal 2	3.3.2	1.20	1...20	3	Dec								
P-243	Programmable signal 3	3.3.2	1.20	1...20	1	Dec								
P-244	Programmable signal 4	3.3.2	1.20	1...20	4	Dec								
P-245	Programmable signal 5	3.3.2	1.20	1...20	5	Dec								
P-246	Programmable signal 6	3.3.2	1.20	1...20	7	Dec								
P-247	Control word, signal	3.3.2	1.20	0...FFFF	0	Hex								
P-248	Delay time, fault message F-11	4.1	2.00	100...10000	750	ms								
P-249	Segment memory location monitor	2.3.5	1.20	0...FFFF	0	Hex								
P-250	Address memory location monitor	2.3.5	1.20	0...FFFF	0	Hex								
P-251	Value display memory location monitor	2.3.5	1.20	-	-	Hex								
(P-254)	Display active function 1	5.1.2	1.20	-	-	Hex								
(P-255)	Display active function 2	5.1.2	1.20	-	-	Hex								
P-256	Delay time "n _{set} = n _{act} " signal	3.3.2	3.00	0,00...0,50	0,20	s								
P-257	Delay time "Md < Mdx" signal	3.3.2	3.00	0,00...1,00	0,80	s								
P-258	Speed for max. useful motor speed mot 2	3.1	1.20	-n _{maxMot} ... n _{maxMot}	n _{maxMot}	RPM								
P-260	n _{min} for "n _{act} < n _{min} " signal mot 2	3.3.2	1.20	0...n _{rated}	12	RPM								
P-261	Shutdown speed pulse cancellation mot 2	2.2.3	1.20	1...n _{rated}	n _{rated} /256	RPM								
P-262	n _x for "n _{act} < n _x " signal	3.3.2	1.20	0...n _{maxMot}	6000	RPM								
P-263	Tolerance bandwidth f.n _{act} = n _{set} signal mot 2	3.3.2	1.20	0...n _{rated} /16	20	RPM								
P-264	Speed limiting mot 2	2.2.3	1.20	0...n _{maxMot}	n _{maxMot}	RPM								
P-265	P gain, speed controller mot 2	4.1	1.20	3,0...120,0 6,0 I..240,0 fr.FW3.1	32,0	Dec								
P-266	Integral action time, speed controller mot 2	4.1	1.20	5...6000	20	ms								
P-267	Changeover speed, motor encoder select. mot 2	2.2.3	1.20	32000	32000	RPM								
P-268	Hysteresis, P-267 mot 2	2.2.3	1.20	0..500	50	RPM								
P-269	1st torque limit mot 2	2.2.3	1.20	5...300	100	%								

P No.	Designation	Sec.	Firm-ware rel.	Setting range	Default	Dim.	Setting value, dependent on the gearbox stage								
							1	2	3	4	5	6	7	8	
P-270	Regenerative limiting	Mot 2	2.2.3	1.20	5...100	100	%								
P-271	2nd torque limit value	Mot 2	2.2.3	1.20	5...100	50	%								
P-272	Changeover speed for P-270	Mot 2	2.2.3	1.20	1...n _{maxMot}	500	RPM								
P-273	Hysteresis, P-272	Mot 2	2.2.3	1.20	0...n _{maxMot}	20	RPM								
P-274	Switch-in speed, torque setpoint smooth.	Mot 2	4.1	1.20	1...n _{maxMot}	4000	RPM								
P-275	Hysteresis, P-274	Mot 2	4.1	1.20	0...n _{rated}	50	RPM								
P-276	Frequency, torque setpoint filter	Mot 2	4.1	1.20	50...450	300	Hz								
P-277	Quality, torque setpoint filter	Mot 2	4.1	1.20	0,10...10,00	1,00	Dec								
P-278	Correction P gain, current controller	Mot 2	4.2	1.20	-255...255	0	Dec								
P-280	Select torque setpoint filter	Mot 2	4.1	1.20	0...1	0	Hex								
P-281	Type torque setpoint filter	Mot 2	4.1	1.20	0...1	0	Hex								
P-283	Lower adaptation speed	Mot 2	4.1	1.20	0...n _{maxMot}	1000	RPM								
P-284	Upper adaptation speed	Mot 2	4.1	1.20	0...n _{maxMot}	1200	RPM								
P-285	P gain, upper adaptation speed	Mot 2	4.1	1.20	0,0...120,0 6,0...240,0 fr.FW3.1	24,0	Dec								
P-286	Reduction factor, P gain	Mot 2	4.1	1.20	1...200	100	%								
P-288	Integral action time, upper adapt.speed	Mot 2	4.1	1.20	5...6000	80	ms								
P-289	Reduction factor, integral action time	Mot 2	4.1	1.20	1...200	100	%								
P-290	Switching speed fr. M _{d1} to M _{d2}	Mot 2	2.2.3	1.20	0...n _{maxMot}	4· n _{rated}	RPM								
P-291	Max. motor temperature	Mot 2	2.2.3	1.20	0...170	Mot.type dep	°C								
P-292	Changeover speed, curr. contr. adapt.	Mot 2	4.2	1.20	500...10000	Mot.type dep	RPM								
P-293	Control word speed controller adaptation	Mot 2	4.1	1.20	0...7	0	Dec								
P-294	Inductance of the series reactor	Mot 2	2.1.2	3.00	0,000...65,535	0,000	mH								
(P-299)	Checksum parameter		5.1.3	2.00	-	-	Hex								
P-311	Current for current/Hz control		5.1.7	1.20	0,0...100,0	0,0	%								
P-312	Frequency for current/Hz control		5.1.7	1.20	0,0...800,0	0,0	Hz								
P-313	Select current/Hz control		5.1.7	1.20	0...1	0	Dec								

P No.	Designation	Sec.	Firm-ware rel.	Setting range	Default	Dim.	Setting value, dependent on the gearbox stage							
							1	2	3	4	5	6	7	8
(P-316)	Display, P gain current controller	4.2	1.20	–	–	Dec								
P-317	Reduction factor, max. load duty cycle I ² t	2.3.7	3.1	25...100	100	%								
P-318	Reduction factor S6 load duty cycle I ² t	2.3.7	3.1	25...100	100	%								
(P-319)	Diagnostics I ² t power model	2.3.7	3.1	0...FFFF	0	Hex								
(P-320)	Diagnostics motor encoder zero mark	5.1.3	3.00											
(P-321)	Diagnostics spindle encoder zero mark	5.1.3	3.00											
(P-322)	I ² t load limiting	2.3.7	3.1	0...100%		%								
(P-330)	Inverter clock cycle frequency	5.1.1	3.00			kHz								
P-331	Inverter clock cycle frequency 2	4.2	3.00	0...7	4	Hex								
P-332	Inverter clock cycle frequency 3	4.2	3.00	0...7	2	Hex								
P-333	Inverter clock cycle frequency 4	4.2	3.00	0...7	6	Hex								
P-340	Speed deviation, slip monitoring	2.3.4	2.00	0,1...100,0	10,0	%								
P-341	Torque reduction, slip monitoring	2.3.4	2.00	0,0...100,0	50,0	%								
P-343	Delay time, slip monitoring	2.3.4	2.00	0...999	200	ms								
P-344	Torque reduced velocity slip monitoring	2.3.4	2.00	0,01...100,00	0,50	%/ms								
P-345	Torque reduced velocity slip monitoring	2.3.4	2.00	0,01...100,00	0,10	%/ms								
P-346	Hysteresis for P-340	2.3.4	2.00	0,0...100,0	0,00	%								
(P-347)	Speed deviation, actual slip monitoring	2.3.4	2.00											

Index**A**

Address, RAM variable, HS/6-112
 Analog output
 fine normalization, HS/3-68
 M/Mrated display, HS/3-68
 nact display, HS/3-68
 P/Pmax display, HS/3-68
 parameterization DAU 1, DAU 2, HS/3-67

B

Bit, HS/1-6
 Built-in motors, HS/6-102

C

C axis, HS/2-25, HS/2-31, HS/3-59
 Code numbers for power modules and standard motors, HS/6-99
 Connection overview
 connection diagram, HS/6-104
 relay terminals, HS/6-106
 star/delta changeover, HS/6-107
 terminals, HS/6-105
 Connections, HS/1-13
 Connector assignment
 for Bero, HS/6-109
 motor encoder signal output, HS/6-110
 spindle encoder, HS/6-109
 Current controller, HS/4-75
 Current de-rating for inverter clock cycle frequencies > 3.2 kHz, HS/1-11

D

DAU, HS/3-67
 Diagnostic parameters, HS/5-81
 Diagnostics, HS/5-77
 Display, HS/2-25, HS/5-87
 Display parameter, HS/2-25
 Display parameters, HS/5-77

E

Encoder phase error correction, HS/2-27

F

Fault, HS/5-92
 acknowledgement, HS/5-87
 display, HS/5-87
 suppression, HS/5-87
 Filter, HS/4-74
 Firmware version, HS/2-26
 Flux adaptation, HS/2-52

G

Gearbox stage, HS/2-25

H

Hexadecimal numbers, HS/1-6

I

I2t limiting (from FW 3.1), HS/2-54
 Initialization
 special motors, HS/2-17
 standard motors, HS/2-15
 star/delta motors, HS/2-21
 Input terminals, HS/3-58
 Inverter clock cycle frequency, HS/4-76
 Inverter clock frequency, HS/3-59

M

M19, HS/2-25, HS/2-30
 Master/slave operation, HS/2-44
 Maximum current limiting (from FW 3.1), HS/2-54
 Measured value displays, HS/5-77
 Minimum speed, HS/3-57
 Mode, HS/2-25
 Module ID, HS/2-26
 Motor code number, HS/6-99
 Motor data set, HS/2-18, HS/2-22
 Motor temperature monitoring, HS/2-29

O

Open-loop torque controlled mode, HS/2-44
 function description, HS/2-44
 master drive, HS/2-44
 slave drive, HS/2-44, HS/2-45
 torque setpoint, HS/2-44, HS/2-45

Index

Operating display, HS/2-25
 Operator control and display elements, HS/1-8
 Orientated spindle stop, HS/2-30
 Oscillation mode, HS/2-29
 Output terminals, HS/3-61

P

Parameter list, HS/6-113
 Parameters
 attributes, HS/1-5
 gearbox–stage dependent, HS/1-8
 list, HS/1-5
 number, HS/1-5, HS/1-8
 setting range, HS/1-5, HS/1-6
 sub–parameter number, HS/1-8
 transferring into the FEPRM, HS/1-9
 value, HS/1-8
 write protection, HS/1-9
 write–protection, HS/1-6
 Power module code number, HS/6-99

R

RAM variables, HS/6-112
 Ramp–function generator, HS/4-70
 Re–initializing the drive converter, HS/1-7
 Relay functions, HS/2-25
 control word, signals, HS/3-63
 freely–programmable, HS/3-61
 permanently–wired, HS/3-61
 signals which can be parameterized, HS/3-63
 variable, HS/3-64
 Replacing components, HS/1-7
 Replacing firmware, HS/1-7
 Replacing modules, HS/1-7

S

Series machines, HS/1-7
 Setting and monitoring data, HS/6-113
 Setting data, HS/1-12
 Slip monitoring, HS/2-46, HS/3-59
 Smoothing
 speed actual value, HS/4-70, HS/4-76
 speed setpoint, HS/3-59, HS/4-69
 torque setpoint, HS/4-73
 Special motors
 flux setpoint characteristic, HS/2-19
 initialization, HS/2-17
 main field inductance-characteristic, HS/2-19
 motor data set, HS/2-18
 Speed actual value smoothing, HS/4-70
 Speed controller
 adaptation, HS/4-72
 gain, HS/4-71
 integral action time, HS/4-71

Speed setpoint interface, HS/3-55
 channel selection, HS/3-55
 minimum speed, HS/3-57
 normalization, HS/3-56
 smoothing, HS/3-59
 unipolar input, HS/3-56
 Speed setpoint smoothing, HS/4-69
 Speed setting value, HS/2-27
 Spindle positioning, HS/2-31
 brief commissioning, HS/2-43
 diagnostic parameters, HS/2-42
 function description, HS/2-31
 position controller, HS/2-37
 Position reference value, HS/2-34
 position reference value, HS/2-33, HS/2-35,
 HS/2-41, HS/2-42, HS/3-59
 relay signal, HS/2-34
 search speed, HS/2-32, HS/2-33, HS/2-39,
 HS/2-41
 zero mark, HS/2-32, HS/2-34, HS/2-35,
 HS/2-36, HS/2-39, HS/2-42, HS/3-59
 zero pulse, HS/2-33, HS/2-38, HS/2-43
 Standard applications, HS/2-25, HS/2-27
 Standard motors, initialization, HS/2-15
 Star/delta motors, HS/6-101
 flux setpoint characteristic, HS/2-23
 initialization, HS/2-21
 main field inductance-characteristic, HS/2-23
 motor changeover, HS/2-24
 motor data set, HS/2-22
 Start–up
 instructions, HS/1-7
 possibilities, HS/1-7
 Status display
 active terminal function, HS/5-79, HS/5-80
 digital inputs, HS/5-78
 Sub–parameter number, HS/1-8

T

Terminal function
 assignment, HS/3-59
 freely–programmable, HS/3-59
 permanently–wired, HS/3-58
 Test sockets, HS/5-82
 Torque limit value, HS/2-28
 Torque setpoint smoothing, HS/4-73
 Transient recorder function, HS/5-84

U

Uncontrolled infeed, HS/2-16
 Unit status, HS/2-25

W

Water–cooled motors, HS/6-101

Induction Motor Modules (AM)

1	First Steps	AM/1-3
1.1	Start-up guidelines	AM/1-4
1.2	Start-up instructions	AM/1-7
1.3	Operator and display elements, control parameters	AM/1-9
1.4	Overview, setting data	AM/1-13
1.5	Connections	AM/1-14
2	Determining and Setting the System Configuration	AM/2-15
2.1	Motor and drive converter data sets	AM/2-15
2.2	Standard applications	AM/2-22
2.2.1	Operating display	AM/2-22
2.2.2	Firmware version	AM/2-23
2.2.3	Setting parameters for standard applications	AM/2-23
2.3	Multi-motor operation	AM/2-27
2.3.1	Parallel operation	AM/2-27
2.3.2	Parameter set changeover	AM/2-32
2.3.3	Motor changeover	AM/2-32
2.4	Operating motors with maximum speeds > 32000 RPM	AM/2-34
2.5	Monitor function	AM/2-36
3	Parameterizing the Drive Converter Interfaces	AM/3-37
3.1	Speed setpoint interfaces	AM/3-37
3.2	Input terminals	AM/3-40
3.2.1	Permanently-connected terminal functions	AM/3-40
3.2.2	Freely-programmable terminal functions	AM/3-41
3.3	Output terminals	AM/3-43
3.3.1	Permanently-connected relay functions	AM/3-43
3.3.2	Freely-programmable relay functions	AM/3-44
3.3.3	Variable relay function	AM/3-47
3.3.4	Analog outputs	AM/3-48
4	Controller Optimization	AM/4-51
4.1	Speed controller	AM/4-54
4.2	Current controller	AM/4-57
4.3	Field controller	AM/4-60
4.4	Optimization, open-loop controlled range	AM/4-61
4.5	Limits	AM/4-62
4.6	Special speeds and speed range	AM/4-63
4.7	Manual optimization	AM/4-65

5	Diagnostics and Fault Analysis	AM/5-75
5.1	Diagnostic resources	AM/5-75
5.1.1	Measured value displays	AM/5-75
5.1.2	Status displays	AM/5-76
5.1.3	Diagnostic parameters	AM/5-79
5.1.4	Test sockets X1, X2, IR	AM/5-80
5.1.5	Minimum/maximum value memory	AM/5-83
5.1.6	Transient recorder function	AM/5-84
5.1.7	Current/Hz control	AM/5-86
5.2	Fault analysis	AM/5-87
5.2.1	Fault display, fault acknowledgement	AM/5-87
5.2.2	Fault message list	AM/5-88
6	Attachments	AM/6-91
6.1	Flowchart when commissioning systems	AM/6-92
6.2	Power module code numbers	AM/6-102
6.3	Connections	AM/6-103
6.4	Interfaces	AM/6-107
6.4.1	X432 connector assignment for BERO	AM/6-107
6.4.2	X412 connector assignment for motor temperature sensor	AM/6-107
6.4.3	X411 serial interface	AM/6-107
6.5	RAM variable addresses	AM/6-108
6.6	Setting and monitoring data (parameter list)	AM/6-109

First Steps

1



Warning

Perfect and safe operation of this equipment assumes that it has been professionally transported, stored, installed and mounted as well as careful operator control and service/maintenance.

Severe bodily injury or material damage can occur if this warning information is not observed.



The modules contain components which can be destroyed by electrostatic discharge.

Please observe the ESD instructions in the foreword.

Note

The board, Order No. [MLFB] 6SN1122-0BA11-0AA1 can only be operated with firmware, from 3.00.

The following board Order Nos. [MLFB]:

6SN1122-0BA11-0AA0

6SN1122-0BA12-0AA0

can only be operated **up to** firmware 2.xx.

AM

Note

Start-up software is available to commission induction motor control systems with an analog setpoint interface.

Ordering data for the software:

Refer to Catalog NC 60 (Order No.: E86060-K4460-A101-A8)

Ordering data for the documentation:

Start-up software for main spindle and induction motor modules

Order No. 6SN1197-0AA30-0AP1

Note

Motor definition

Standard motor: Motors which are included in the Siemens Catalog.

Third-party motor: Third-party motor manufacturers.

Special motor: Motor manufactured by Siemens to customer specifications.

1.1 Start-up guidelines

Structure of the Start-up Guide

The Start-up Guide is structured in the sequence of the actual start-up steps.

To start-up (commission) standard applications, where the drive converter interfaces (Section 1.5) and controller optimization settings are generally adequate when supplied, only the start-up steps in bold are of significance.

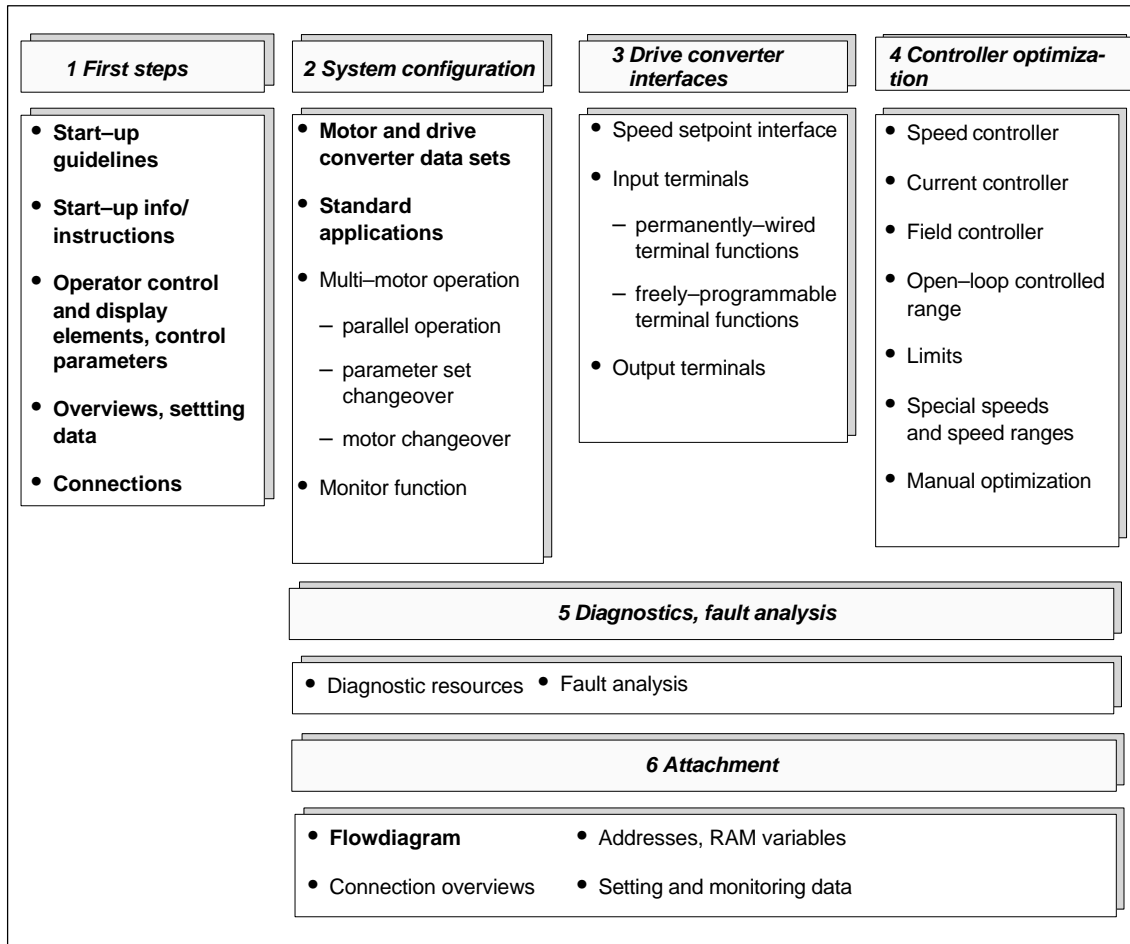

Fig. 1-1 Start-up steps

Parameter lists



Warning

The setting values of parameters, which are not listed in the parameter list (refer to Section 6.6), may not be changed.

The parameter descriptions are structured as information units in the form of tables.

The sequence of the parameters in these tables represents the procedure when parameterizing the equipment.

Table 1-1 Example of a parameter list

Parameter attributes			Setting range	Description
Number	Change effective	P-051		
P-024	Online	4	Value range Dimensions	Parameter designation Brief parameter description FW x.xx
P-014.M P-039.G P-114.F (P-001)	After initialization	10		

Parameter attributes

- **Number**
 - P-024
generally valid parameter
 - P-014.**M**
motor-dependent parameter
sub-parameters P-014.1...P-014.4
 - P-039.**G**
gearbox stage-dependent parameter
sub-parameters P-039.1...P-039.8
 - P-114.**F**
fixed setpoint-dependent parameter
sub-parameters P-114.1...P-014.7
 - (P-001)
display parameter; value cannot be changed.

1.1 Start-up guidelines

- **Change effective**
 - online
Change is immediately effective.
 - after initialization
Initialization is initialized by setting P-097 to 1H.
- **P-051**
Write protection parameters
Write protection is removed by entering 04H, or removing the special write protection by entering 0010H.

Setting range

For several control words, the functions are activated by setting bits of a binary number, and entering these in a hexadecimal form.

Example:

BIT	15	14	13	12	11	10	9	8	7	6	5	4	3	2	1	0		
Bit 6:	0	0	0	0	0	0	0	0	0	1	0	0	0	0	0	0	Bin	0040H
Bit 7:	0	0	0	0	0	0	0	0	1	0	0	0	0	0	0	0	Bin	0080H

A combination of several functions is entered by adding the binary or hexadecimal values.

Example:

BIT	15	14	13	12	11	10	9	8	7	6	5	4	3	2	1	0		
Bit 6+Bit 7	0	0	0	0	0	0	0	0	1	1	0	0	0	0	0	0	Bin	00C0H

Description

- **FW x.xx**
Firmware-dependent identification of function and parameter extensions. The extension is available from the specified firmware release.

1.2 Start-up instructions

Start-up

Using

- Operator control and display elements (refer to Section 1.3)
- RS232C interface with an IBM AT-compatible computer and start-up software (refer to foreword).

Re-initializing the drive converter (if required)

If an already initialized drive converter is to be re-initialized, then the following procedure must be followed:

- If required, save the setting data (parameters).
- Remove the write protection: Set P-051 to 4H.
- Start initialization: Set P-097 to 0H.
- Overwrite the parameters in the drive-machine data memory: Set P-052 to 1H and wait until P-052 resets itself back to 0H.
- Power-on reset:
Power-down the unit and approx. 2 s after the display has gone dark, power-up the unit again:
P-095 or P-096 must be displayed.
- Initialize (Section 2.1).

Replacing the firmware (if required)

From version V2.00, the firmware can be replaced using the user-prompted start-up software for main spindle and induction motor modules.

Inter-dependency between the firmware release and board

Firmware release	Board
Before FW 3.00	6SN1122-0BA1□-0AA0
From FW 3.00	6SN1122-0BA11-0AA1

Procedure:

- Save the setting data (parameters).
- Replace the firmware using the start-up program.
- Initialize with the pulses and controller inhibited (Section 2.1).
- Re-load the setting data which has been saved.
- Adjust the power offset.
(refer to Table 4-1, from FW 3.00, not required)
- Save the setting data in the drive-machine data memory (Section 1.3).

1.2 Start-up instructions

Starting-up series machines, replacing modules, replacing components

The drive converter setting data (parameters) can be saved on floppy disk using the start-up software.

The following procedure must be maintained for the series start-up of additional drive converters:

1. Initialize.
 - activate pulse and controller inhibit.
 - enter P-095 power module code in accordance with Table 6-1.

Note:

Power modules with Order No. [MLFB] 6SN112□-1A□□□-□□A1, are, from FW 3.00, automatically recognized. It is then no longer possible/necessary to make an entry in P-095.

- Start initialization.
2. Load the setting data from the floppy disk.
 3. Adjust the power offset according to Table 4-1.

Note:

This is not necessary from FW 3.00.

4. Save.

1.3 Operator and display elements, control parameters

Operator and display elements

The following operator and display elements are provided on the front panel to start-up and parameterize SIMODRIVE 611-A IM modules:

- 3 operator keys (**+**, **P** and **-**)
- 6-character LCD display

Gearbox stage-dependent parameters and the fixed setpoint-dependent P-114 are shown with 8 sub-parameter numbers (e. g. P-039.1 to P-039.8).

Motor-dependent parameters are shown with 4 sub-parameter numbers (e.g. P-014.1 to P-014.4).

The functions of the operator elements are shown using as an example parameter P-039.

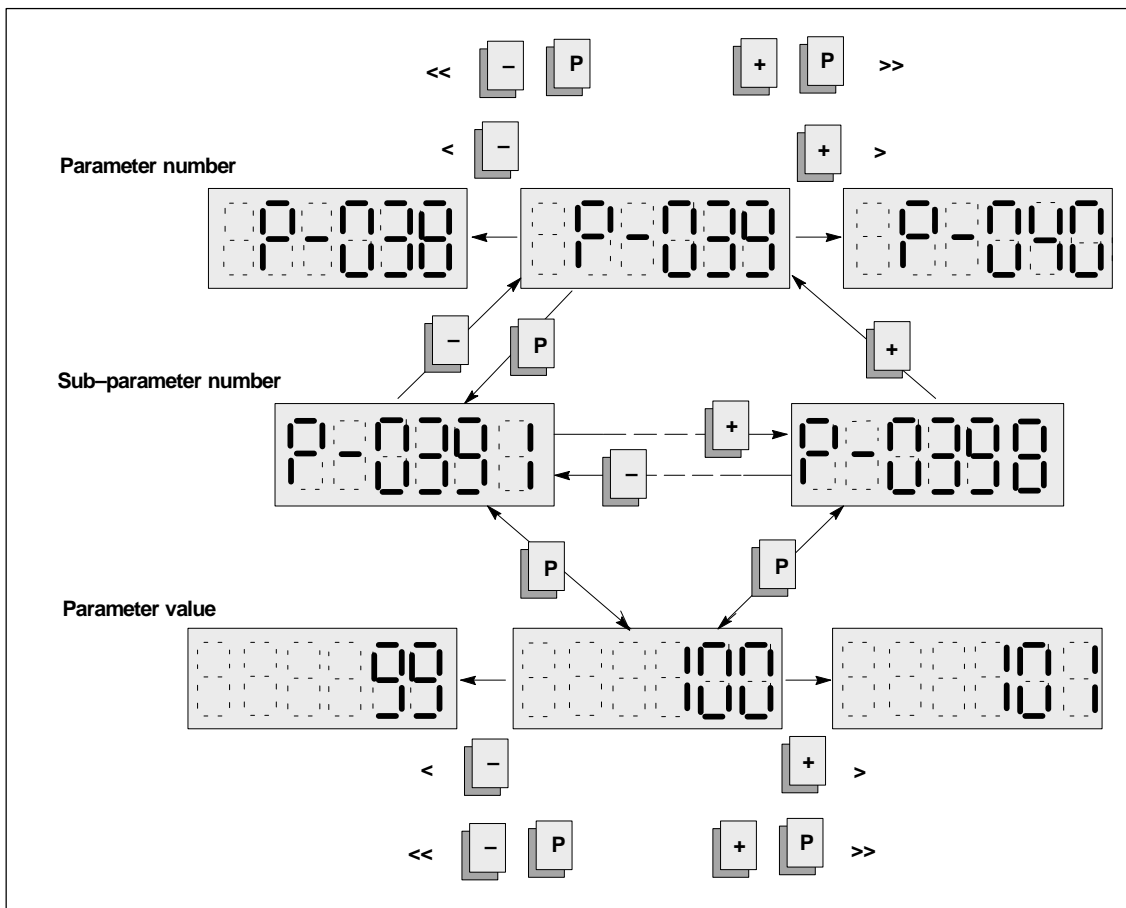

AM

1.3 Operator and display elements, control parameters

Control parameters

Note

If the data save (P-052) is interrupted due to power failure or power-down, then the values which have been changed are lost, and the drive converter outputs fault message "F-07" when it is powered-up again (refer to Section 5.2.2). The parameter values can be re-set after fault message "F-07" has been acknowledged.

Table 1-2 Control parameters

Parameter attributes			Setting range	Description		
Number	Change effective	P-051				
P-051 P-151	Online	–	0...FFFF hex	Write protection Write protection is removed by entering 4H. Special write protection is removed by entering 10H.		
P-052 P-152	Online	4	0...1 dec	Parameter transfer into the FEPROM By setting to 1, parameters are transferred into the non-volatile drive-machine data memory. The parameters are automatically reset after transfer.		
P-053	Online	4	0...FFFF hex	Control word		
				Bit	Value	
				0	0000H	Ready relay pulls-in if there is no fault and the pulses and controller are enabled
					0001H	Ready relay pulls-in if there is no fault.
				1	0000H	Motor parameter set is changed-over after another motor has been selected and subsequent pulse cancellation (motor changeover).
					0002H	The motor parameter set is immediately changed-over after another motor has been selected (parameter set changeover)
2	0000H	For ramp-function generator fast stop (terminal 81) the pulses are not canceled when absolute speed value n_{min} (P-022) is fallen below.				
	0004H	For ramp-function generator fast stop (terminal 81) the pulses are canceled when the absolute speed value n_{min} (P-022) is fallen below.				
3	0000H	The ramp-function generator is not tracked.				
	0008H	The ramp-function generator is tracked. For a ramp-function generator which is set too fast, the ramp-function generator tracking immediately responds to an opposing setpoint change.				

1.3 Operator and display elements, control parameters

Table 1-2 Control parameters

Parameter attributes			Setting range	Description		
Number	Change effective	P-051				
P-053	Online	4	0...FFFF hex	Control word		
				Bit	Value	
				5	0000H	Faults are not influenced by the controller inhibit at terminal 65.
					0020H	Faults can be acknowledged using the controller inhibit at terminal 65.
				7	0000H	The speed actual value is searched for starting from the speed setpoint. Optimum run-up is not guaranteed when the pulses are enabled for a stationary motor or a motor rotating in the opposite direction.
					0080H	The speed actual value is searched for starting from 0. When the pulses are enabled for a rotating motor, this is first braked, and is then accelerated to the speed setpoint from the open-loop controlled speed range.
				8	0000H	Integral component of the field controller is deleted when the voltage is limited. The voltage limiting might even be able to be left again.
					0100H	Integral component of the field controller is not influenced for voltage limiting. However, voltage limiting cannot be automatically left, as the field-generating current continually increases.
13	0000H	KTY84 motor temperature sensor according to IEC 134				
	2000H	PTC motor temperature sensor according to IEC 134; from FW 3.00				
15	0000H	The parameter number is cyclically displayed on the LCD display				
	8000H	The parameter number is not cyclically displayed on the LCD display; from FW 3.00				
P-090	Online	4	0...FFFF hex	Control word		
				Bit	Value	
				0	0000H	Parameter display, hexadecimal format Caution! Parameter setting limits in the hexadecimal format are not effective!
0001H	Parameter display, decimal format or hex format					

1.3 Operator and display elements, control parameters

Table 1-2 Control parameters

Parameter attributes			Setting range	Description	
Number	Change effective	P-051			
				2	0000H Adaptation of field-weakening speed and stall torque to the DC link voltage specified at P-061 is inhibited. 0004H The adaptation of the field-weakening speed and stall torque at the DC link voltage, specified by P-061, is enabled (from FW 2.00).
				3	0000H Speed controller clock cycle, standard 0008H Speed controller clock cycle, fast When bit 3 is changed it only becomes effective after saving in the FEPR0M and line supply off/on; from FW 3.00
P-153	Online	10	-1...1 dec	Calculate motor data/controller data Parameters are changed when calculating +1 calculate equivalent circuit diagram data -1 calculate controller data After the calculation, the parameters are automatically reset.	

1.4 Overview, setting data

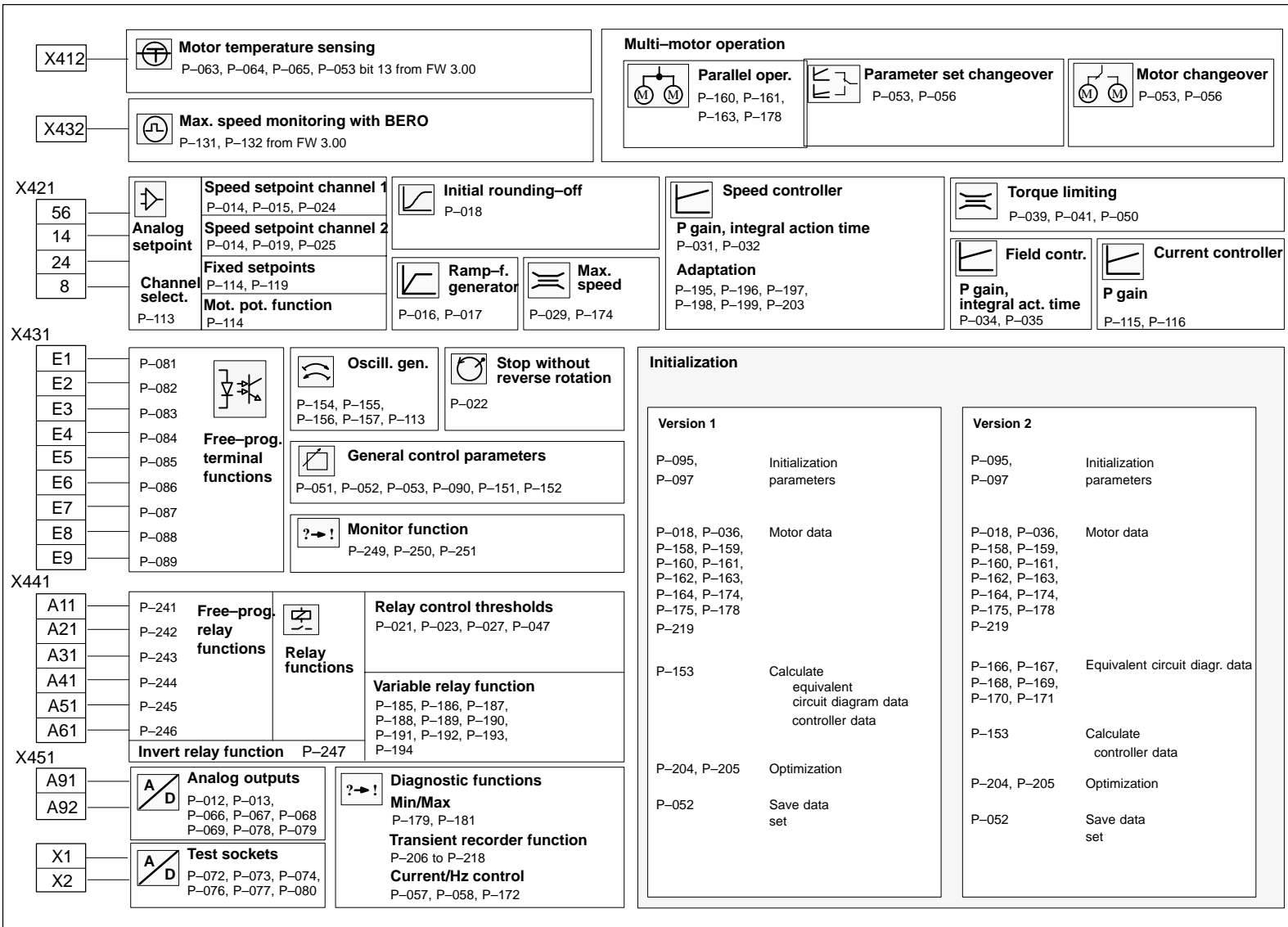

Fig. 1-2 Setting data



1.5 Connections

1.5 Connections

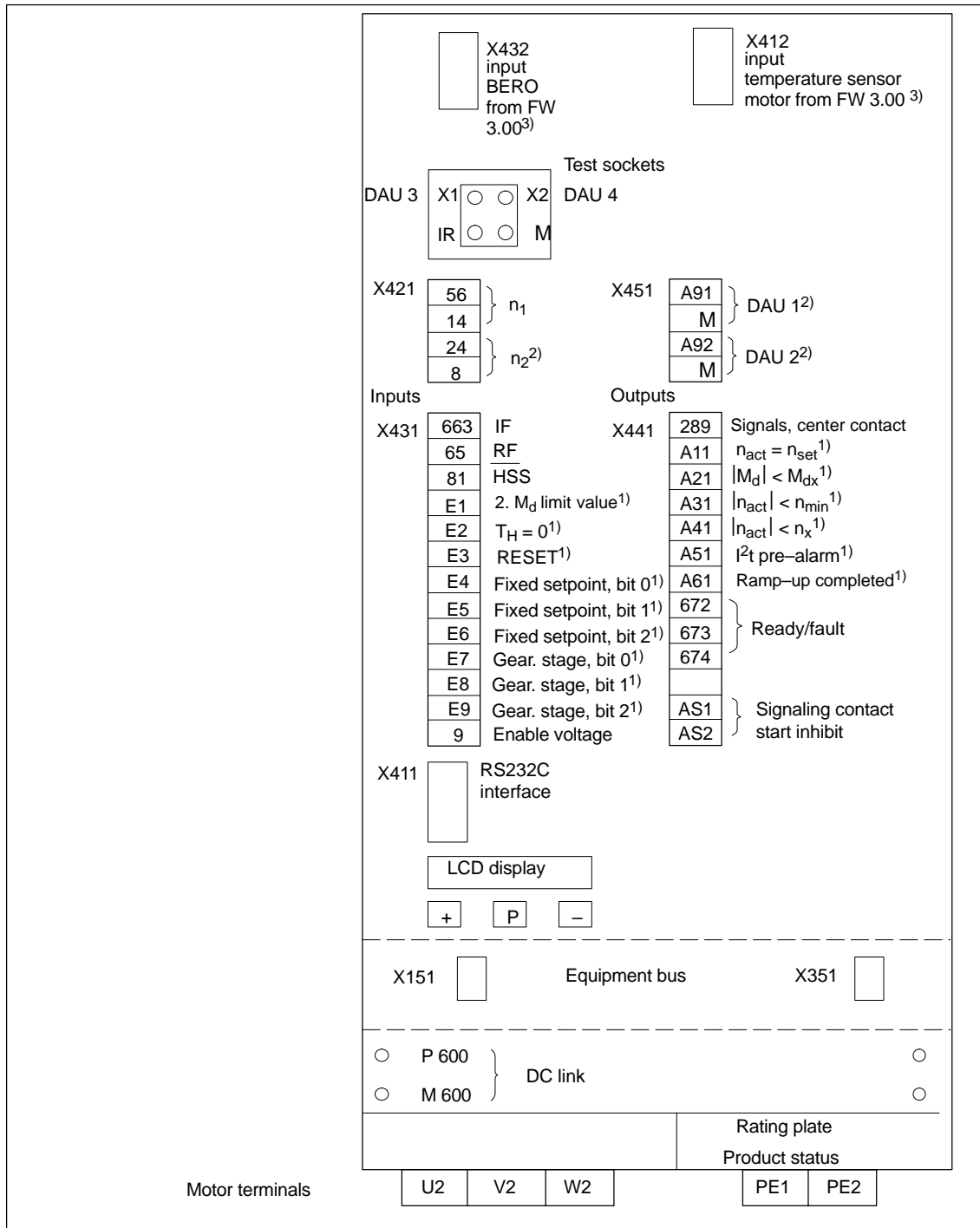

Fig. 1-3 Connections

- 1) Freely-programmable terminals and relay function when supplied
- 2) Function not possible for Order No. [MLFB] 6SN1122-0BA11-0AA0
- 3) Only for Order No. [MLFB] 6SN1122-0BA11-0AA1. For boards with Order No. [MLFB] 6SN1121-0BA1□-0AA0 this input may not be assigned

Determining and Setting the System Configuration

2



Warning

Incorrect setting values in P–159 to P–176 can cause the motor to accelerate up to inadmissibly high speeds and terminal 64 (NE: Central drive inhibit) and terminal 65 (controller inhibit) are ineffective.

In this case, only terminal 63 “open” (NE: Central pulse inhibit) and terminal 663 “open” (axis–specific pulse inhibit) are effective.

2.1 Motor and drive converter data sets

Overview

- Initialization
- Sensing the DC link voltage
- Motor data set
- Speed ranges

2.1 Motor and drive converter data sets

Initialization

Table 2-1 Initialization

Parameter attributes			Setting range	Description
Number	Change effective	P-051		
P-095	After initialization	–	1...13 dec	Power module code number Default: 7 from FW 3.0 pre-setting: 3 ¹⁾ Power module code number input (refer to Section 6.2)
P-096.M	After initialization	–	0...7 dec	Motor code number Default: 0 (do not change)
P-097	Online	–	0...1 hex	Initialization <ul style="list-style-type: none"> • “SEtUP” is displayed Selected power module data set is loaded into the drive-machine data memory • “P-000” operating display is displayed after a successful initialization

Sensing the DC link voltage

Table 2-2 Sensing the DC link voltage

Parameter attributes			Setting range	Description
Number	Change effective	P-051		
P-061	Online	4	0...700 V	Fixed DC link voltage 0 The DC link voltage is sensed via the NE and equipment bus Recognizable at: P-061 = 0 Parameter (P-006) indicates the DC link voltage. 1...700 Enters the value of the actual DC link voltage when using a monitoring module without voltage sensing.

1) With/from FW 3.00, power modules with Order No. [MLFB] 6SN112□-1A□0□-□□A1 are automatically recognized. It is then not possible to change P-095.

Motor data set

For special motors, the motor data must be entered. The controllers can then be optimized with the self-tuning routine in accordance with Section 4.

Table 2-3 Motor data set

Parameter attributes			Setting range	Description
Number	Change effective	P-051		
P-158.M	Online	4	0.000...65.000 mH	Series reactor inductance Used for motors with $f_{max} > 150$ Hz
P-159.M	Online	4	0.0...6535.5 gm ²	Moment of inertia, motor and external Application-specific Total moment of inertia referred to the motor shaft Motor moment of inertia calculated using P-153 = +1 Total moment of inertia adjusted using P-204 =5 and P-205 = +
P-219.M	Online	4	0...15 kgm ²	Additional moment of inertia The parameterized value is internally added to P-159.M. It is only necessary to enter in P-219.M, when the setting range of P-159.M is exceeded. (from FW 2.00)
P-160.M	Online	4	0.00...650.00 kW	Rated motor output ¹⁾ Rated output for S1 operation For forced-cooled motors, refer to the following information
P-161.M	Online	4	0.00...650.00 A	Rated motor current ¹⁾ Rated current for S1 duty Circuit type Y or Δ
P-162.M	Online	4	0.00...650.00 V	Rated motor voltage Rating plate data ¹⁾ Circuit type Y or Δ
P-163.M	Online	4	0...65000 RPM	Rated motor speed ¹⁾ Non-synchronous speed at rated frequency and rated load $n_{rated} < (f_{rated} \cdot 60 \text{ s/min})/p$
P-164.M	Online	4	0...1200.0 Hz	Rated motor frequency ¹⁾ $f_{rated} > n_{rated} \cdot p/(60 \text{ s/min})$
P-166.M	Online	4	0... I_{rated} LT	No-load motor current Equivalent circuit diagram value Calculated using P-153 = +1 Adjusted using P-204 = 3 and P-205 = +1
P-167.M	Online	4	0.000...65.000 Ω	Motor stator resistance, cold Equivalent circuit diagram value Calculated using P-153 = +1
P-168.M	Online	4	0.000...65.000 Ω	Motor rotor resistance, cold Equivalent circuit diagram value Calculated using P-153 = +1 Adjusted using P-204 = 6 and P-205 = +1
P-169.M	Online	4	0.000...65.000 Ω	Stator leakage reactance Equivalent circuit diagram value Calculated using P-153 = +1
P-170.M	Online	4	0.000...65.000 Ω	Rotor leakage reactance Equivalent circuit diagram value Calculated using P-153 = +1

1) Manufacturer's data according to VDE 0530, Part 1

2.1 Motor and drive converter data sets

Parameter attributes			Setting range	Description
Number	Change effective	P-051		
P-171.M	Online	4	0.00...650.00 Ω	Magnetizing reactance Equivalent circuit diagram value Calculated using P-153 = +1 Adjusted using P-204 = 4 and P-205 = +1
P-172.M	Online	4	0...32000 RPM	Changeover speed, closed-loop/open-loop control Calculated using P-153 = +1
P-173.M	Online	4	0...32000 RPM	Speed at the start of field weakening Calculated using P-153 = +1 For operation with an uncontrolled infeed and FW<2.00, the determined value should be multiplied by the factor $(V_{\text{supply}}/500V)$ (this corresponds to 0.8 for $V_{\text{supply}}=400V$). From FW2.00, the control algorithm automatically adapts itself to the DC link voltage (P-006). The automatic adaptation can be disabled by resetting bit 2 in P-090.
P-174.M	Online	4	0...32000 RPM	Max. motor speed ¹⁾ For no-load current optimization, enter $n_{\text{max}} \geq (f_{\text{rated}} \cdot 60 \text{ s/min})/p$, otherwise "F-60" (p=pole pair number)
P-175.M	Online	4	0.0...500.0 min	Thermal motor time constant ^{1) 2)}
P-176.M	Online	4	0...32000 RPM	Speed at the start of stall torque Calculated using P-153 = +1 For operation with an uncontrolled infeed and FW<2.00, the determined value should be multiplied by the factor $(V_{\text{supply}}/500V)$ (this corresponds to 0.64 for $V_{\text{supply}}=400V$). From FW2.00, the control algorithm automatically adapts itself to the DC link voltage (P-006). The automatic adaptation can be disabled by resetting bit 2 in P-090.
P-178.M	Online	4	0.000...1.000	Power factor cos φ ¹⁾
P-018.M	Online	4	4.00...100.00 ms	Initial rounding-off For motors with deep-bar squirrel-cage rotors: Increase this parameter to approx. 30 ms
P-036.M	Online	4	0...7 hex	Inverter clock cycle frequency If the clock cycle frequency is increased, the current controller dynamic response is improved, but the permissible continuous current load capacity is reduced. Especially for high-speed motors, the clock cycle frequency should be selected as high as possible, however, the specified power de-rating (reduction) should be kept. If the clock cycle frequency is changed, then the current controller must be re-optimized.

1) Manufacturer's data according to VDE 0530, Part 1

2) Only when using the motor temperature tracking function for relay function 5 (I²t pre-alarm)

Parameter attributes			Setting range	Description
Number	Change effective	P-051		
P-153	Online	4	-1...1 dec	Calculating the equivalent circuit diagram data of the actual motor Enter +1 for pulse inhibit, terminal 63 or terminal 663. The calculations are started for the entered special motor.
P-153	Online	4	-1...1 dec	Calculating the control data of the actual motor Enter -1 for pulse inhibit, terminal 63 or terminal 663 The calculations are started for the entered special motor.
For high-speed motors, increase the speed limiting P-029 = 6000 RPM to the max. speed.				

Note

The motor circuit configuration should be selected so that neither the required terminal voltage exceeds the maximum drive converter output voltage, nor the IM module is operated with $I_{\text{rated motor}} < 0.1 \cdot I_{\text{cont. module}}$ (refer to examples 1 and 2).

Example 1

If a motor with $V_{\text{rated}} 230 \text{ V } \Delta/400 \text{ V Y}$ is operated from an uncontrolled infeed module in the Y circuit configuration, the motor does not achieve the same output as when operated from a controlled I/R module with $V_{\text{DC link}} = 600 \text{ V} / 625 \text{ V}$. The reason for this is the reduced speed for the start of field weakening (P-173) and the reduced speed at the start of the stall torque (P-176).

If the motor is switched into a delta configuration, this reaches the full rated output for a drive converter dimensioned for $I_{\text{rated}\Delta \text{ motor}}$.

Example 2

If a motor is operated with a rated current in the Y circuit configuration $I_{\text{ratedY motor}} < 0.1 \cdot I_{\text{cont. module}}$, then this can be adapted to the I/M module using the Δ circuit, if the following is valid:

$$I_{\text{rated}\Delta \text{ motor}} \geq 0.1 \cdot I_{\text{cont. module}}$$

Note

If only values for S6 duty are available as rating plate data, then these must be converted to S1 duty for parameterization, and the limits must be increased **after** optimization. For force-cooled motors, the rating plate data must be converted to data for S1 duty of a **non-ventilated** motor of the same frame size for parameterization, and the limits must be increased **after** optimization.

Converting the rating plate data

- Determine the no-load current I_0 , refer to Section 4
- Determine the rated current for S1 duty: $I_{\text{rated S1}} = (2 \dots 2.5) \cdot I_0$
- Determine the rated output for S1 duty: $P_{\text{rated S1}} = P_{\text{rated S6}} \cdot \frac{I_{\text{rated S1}}}{I_{\text{rated S6}}}$
- Commission (start-up) with S1 values and optimization with limits $\leq 100\%$
- The limits are increased for S6 duty and for force-cooled operation.

Speed ranges

Table 2-4 Speed ranges

Parameter attributes			Setting range	Description
Number	Change effective	P-051		
P-172.M	Online	4	0...32000 RPM	Changeover speed, closed-loop/open-loop control Start of the controlled speed range Above this speed and the hysteresis, the speed is controlled according to the calculated speed actual value.
P-173.M	Online	4	0...32000 RPM	Speed at the start of field weakening Start of the field weakening range Above this speed, the drive converter output voltage and frequency are no longer set proportional to one another.
P-176.M	Online	4	0...65535 RPM	Speed at the start of stall torque Start of de-rating Above this speed, the power in the field-weakening range is reduced in order to prevent the motor stalling.

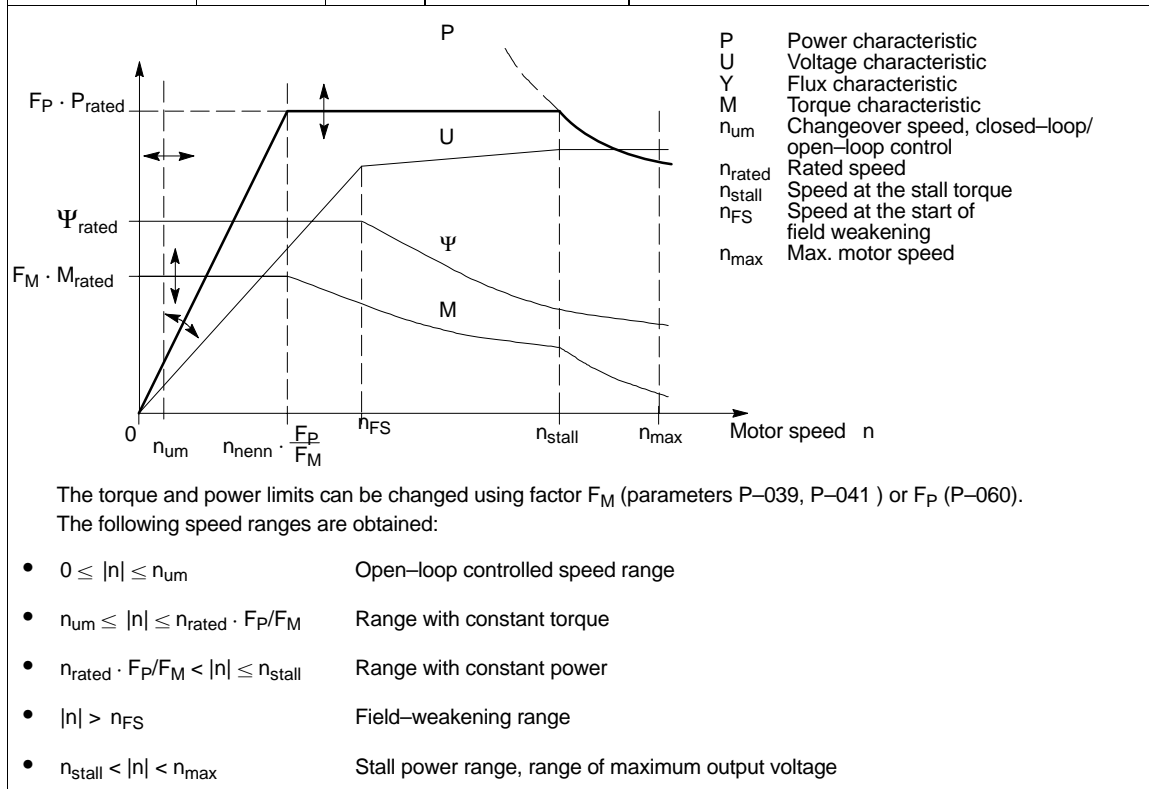

2.2 Standard applications

2.2 Standard applications

2.2.1 Operating display

The actual operating display of the drive converter is shown in parameters P-000 and P-100.

Table 2-5 Operating display

Display					
Function group					
Motor number	Relay function	Operating mode	Unit status	Setpoint source	Gearbox stage
Motor 1 is selected	Free-progr. relay function 1, terminal A11 P-241 $n_{act} = n_{set}^1)$	Drive not enabled: Continue condition, refer to the "Unit status" column	Pulse enable at the NE module missing (term.63 / term.48)	Analog setpoint Ch.1 P-113=1 Ch. 2 P-113=2 Ch.1+2 P-113=3	Gearbox stage 1 is selected
Motor 2 is selected	Free-progr. relay function 2, terminal A21 P-242 $ M_{dl} < M_{dx}^1)$	All enable signals present: Open-loop or closed-loop speed controlled operation	Axis-specific pulse enable missing (term.663)	Analog setpoint + fixed setpoint Ch. 1 + freely-progr. terminal function 17, 18, 19, 24 P-113=9	Gearbox stage 2 is selected
Motor 3 is selected	Free-progr. relay function 3, terminal A31 P-243 $ n_{act} < n_{min}^1)$		Controller enable at the NE module missing (term.64) and/or controller enable at the IM module missing (term.65)	Setpoint zero P-113=0 P-113=7 P-113=8	Gearbox stage 3 is selected
Motor 4 is selected	Free-progr. relay function 4, terminal A41 P-244 $ n_{act} < n_x^1)$		RFG enable missing (term.81)	Fixed setpoint 1...7	Gearbox stage 4 is selected
Motor selection 1...4 Selected via freely programmable-terminal function P-081...P-089 =20, 21	Free-progr. relay function 5, terminal A51 P-245 I^2t pre-alarm ¹⁾		Setpoint enable missing (select terminal fct. No. 16)	Fixed setpoint 8...15 Selected via freely-progr. terminal fct. P-081...P-089 =17, 18, 19, 24 speed setting with P-114.1...7, P-119.1...8	Gearbox stage 5 is selected
	Free-progr. relay function 6, terminal A61 P-246 ramp-up ended ¹⁾		Mode display for an enabled motor: Motor operation Generator operation	Setpoint from the motorized pot. fct. P-113=6 P-114.8 speed or P-081...P-089 =14, 15	Gearbox stage 6 is selected
	Ready/fault, terminals 672 to 674 P-053 ready ¹⁾		Speed controller clock cycle, fast. Clock cycle is active	Setpoint from the oscillation generator P-113=4 or P-081...P-089=2 P-154, P-155 speeds P-156, P-157 times	Gearbox stage 7 is selected
	The segment is controlled, if the appropriate relay has pulled-in.			Setpoint from the software for auto-optimization P-204=1...6 P-205=1	Gearbox stage 8 is selected Gearbox stage 1...8 Selected via freely-programmable terminal function P-081...P-089 =9, 10, 11

1) As supplied

2.2.2 Firmware version

Table 2-6 Firmware version

Parameter attributes			Setting range	Description
Number	Change effective	P-051		
(P-099)	–	–	0.00...99.99	Firmware release Indicates the version of the loaded firmware.

2.2.3 Setting parameters for standard applications

Overview

- Speed setting values
- Max. speed monitoring via BERO
- Torque limit value
- Motor temperature monitoring
- Motor temperature simulation
- Oscillation operation

Speed setting values

Table 2-7 Speed setting values

Parameter attributes			Setting range	Description
Number	Change effective	P-051		
P-022.M	Online	4	2...16000 RPM	Shutdown speed, pulse cancellation The drive switched into a no-current condition if the controller is inhibited and this speed is fallen below (shutdown so that it does not rotate backwards).
P-029.G	Online	4	0...32000 RPM	Speed limiting The speed of the actual motor is limited to the limit the actual gearbox stage. Selected with freely-programmable terminal function 9, 10, 11.

Max. speed monitoring via BERO

A BERO switch can be connected via X432 to monitor the maximum speed. When the shutdown threshold is exceeded, the pulses are canceled and fault message F-90 is output (from FW 3.00).

2.2 Standard applications

Cable breakage monitoring

If no BERO pulses are received for a calculated speed of greater than 1200 RPM/pulse number, then a cable breakage is assumed. F-90 is also output.

Table 2-8 Cable breakage monitoring

Parameter attributes			Setting range	Description
Number	Change effective	P-051		
P-131.M	Online	4	0...10 RPM	Pulse number, BERO speed monitoring For a value of zero, the speed monitoring is inactive.
P-132.M	Online	4	0...65535 RPM	Shutdown speed, speed monitoring BERO

Torque limit values

Table 2-9 Torque limit values

Parameter attributes			Setting range	Description
Number	Change effective	P-051		
P-039.G	Online	4	0...399 %	1st torque limit value The torque is limited to the selected percentage of the rated torque of the actual motor.
P-041.G	Online	4	0...399 %	2nd torque limit value The torque is limited to the selected percentage of the rated torque of the actual motor. The 2nd torque limit is selected using the freely-programmable terminal with terminal function 1 and speed greater than P-050 switching speed M_{d1} to M_{d2}

Motor temperature monitoring

A motor temperature sensor can be connected via X412.
(from FW 3.00)

Temperature sensor types

One of the two can be selected

- KTY84: The measured resistance is converted into a temperature. The maximum permissible temperature can be parameterized.
- PTC: Resistances which are measured to be less than 1330 Ohm are considered to be reliable, resistances greater than 1330 Ohm are interpreted as an overtemperature condition.

Pre-alarm and shutdown behavior

- After approx. 1s: "Pre-alarm motor overtemperature" relay
After the time in P-065: Pulse cancellation and fault message F-14

Sensor cable interruption and short-circuit

- KTY84: Measured temperatures under approx. 0 degrees C or above approx. 200 degrees C result in pulse cancellation and fault message F-19
- PTC: Sensor cable interruption and short-circuit are not recognized.

Table 2-10 Motor temperature monitoring

Parameter attributes			Setting range	Description
Number	Change effective	P-051		
P-053.M	Online	4	0...FFFFhex	Control word
				Bit Value
				13 0000H Type, motor temperature sensor KTY84
				2000H Type, motor temperature sensor PTC
P-063.M	Online	4	0...170 degrees C	Max. motor temperature Only effective for KTY84. The shutdown threshold cannot be parameterized for PTC.
P-064.M	Online	4	0...170 degrees C	Fixed temperature The motor temperature monitoring is activated by entering a value of zero.
P-065.M	Online	4	0...600s	Timer stage, motor temperature alarm

Motor temperature emulation

Table 2-11 Motor temperature emulation

Parameter attributes			Setting range	Description
Number	Change effective	P-051		
P-175.M	Online	4	0.0...500 min	Thermal motor time constant For free-programmable relay function 5, I ² t monitoring

Note

A dedicated temperature model is computed for each of the motor parameter sets.

However, quantities such as the effect of the fan and air intake temperature cannot be taken into account. This is the reason that it is preferable if the temperature is monitored using a motor temperature sensor.

Oscillation operation

Table 2-12 Oscillation operation

Parameter attributes			Setting range	Description
Number	Change effective	P-051		
P-154	Online	4	-32000...32000 RPM	Oscillation setpoint 1
P-155	Online	4	-32000...32000 RPM	Oscillation setpoint 2
P-156	Online	4	0.002...60 s	Oscillation interval time 1
P-157	Online	4	0.002...60 s	Oscillation interval time 2
				Selected using a freely-programmable terminal function 2 or P-113=4

The graph illustrates the speed oscillation process. The vertical axis represents Speed [RPM], and the horizontal axis represents Time [s]. The speed starts at a high level (P-154), drops to a low level (P-155) for a duration (P-156), then stays at the low level for a longer duration (P-157), and then returns to the high level. The low level is indicated by a dashed line.

2.3 Multi-motor operation

The following applications can be combined with one another:

- Parallel operation
- Parameter set changeover
- Motor changeover

Motor selection

Table 2-13 Motor selection

Parameter attributes			Setting range	Description
Number	Change effective	P-051		
P-056	Online	4	0..4	Motor selection Select actual motor 0 Selected via freely-programmable terminal function 20, 21. 1...4 Motor 1...4 active

Note

The parameter set is only changed-over after the pulses have been canceled if P-053 bit 1 = 0.

AM

2.3.1 Parallel operation

Several motors can be simultaneously operated from an IM module. The motors are supplied with the same voltage and same frequency due to the parallel circuit configuration. This means that the motors must have the same voltage-frequency characteristic, i. e. the ratios of the rated voltage and rated frequency of the individual motors must be the same. For different motor types, the ratio of the outputs should not exceed 1 : 10.

If the motors connected in parallel have the same pole pair number, they rotate with approximately the same speed.



Warning

For different loads, the speeds differ by the difference of the slip speeds, i.e. an individual motor deviates from the calculated speed of the complete system, and can then exceed a selected speed limit.

2.3 Multi-motor operation

The drives have a stronger tendency to stall when operated in a parallel circuit configuration compared to individual operation. In order to be able to better compensate load surges, we recommend that the current limit **P-059** should be set to 150 % of the summed current. If a steady-state rated torque is demanded in the lower speed range, then **P-057** (current in the open-loop controlled range) should also be increased. The induction motor module should be dimensioned for this current rating, and it should be ensured that the motors are adequately cooled.

When operated in parallel, only the total current can be sensed which is then distributed to the individual motors depending on the load. This means that these should be externally and **individually** thermally monitored. If the monitoring function responds, it is **not** permissible to interrupt the power cables **without** first canceling the pulses.

For high-speed special-purpose motors ($f_{max} > 150$ Hz), we recommend that a reactor is located between the induction motor module and the motor group.

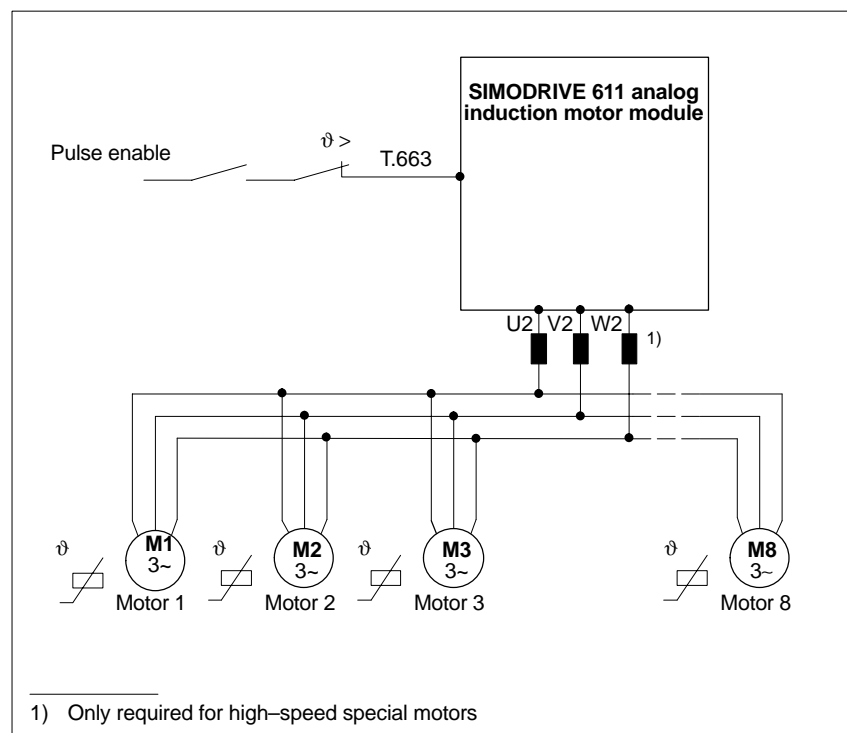

Fig. 2-1 Parallel operation from a SIMODRIVE 611 analog induction motor module

The motor data must be entered as follows for parallel operation:

Table 2-14 Parallel operation

Parameter attributes			Setting range	Description
Number	Change effective	P-051		
P-158.M	Online	4	0.000...65.000 mH	Series reactor inductance Used for motors with $f_{max} > 150$ Hz.
P-160.M	Online	4	0.00...650.00 kW	Rated motor output ¹⁾ Sum of the rated outputs for S1 duty $\sum P_{rated\ i} = P_{rated\ tot}$
P-161.M	Online	4	0.00...650.00 A	Rated motor current ¹⁾ Sum of the rated currents for S1 duty $\sum I_{rated\ i}$ Circuit type Y or Δ
P-162.M	Online	4	0.00...650.00 V	Rated motor voltage ¹⁾ Rated voltage of the common V/Hz characteristic Circuit type Y or Δ
P-163.M	Online	4	0...65000 RPM	Rated motor speed ¹⁾ Output-weighted average value of the rated speed $\sum \frac{P_{rated\ i}}{P_{rated\ tot}} \cdot n_{rated\ i}$ Non-synchronous speed at rated frequency and rated load $n_{rated} < (f_{rated} \cdot 60\text{ s/min})/p$
P-164.M	Online	4	0...1200,0 Hz	Rated motor frequency ¹⁾ Rated frequency of the common V/Hz characteristic $f_{rated} > n_{rated} \cdot p/(60\text{ s/min})$
P-174.M	Online	4	0...32000 RPM	Max. motor speed Manufacturer's data Lowest maximum speed of the motor group, reduced by the maximum slip difference. To optimize, enter the no-load $\cdot n_{rated\ i}$ load current $n_{max} \geq (f_{rated} \cdot 60\text{ s/min})/p$, otherwise "F-60" (p=pole pair number)
P-178.M	Online	4	0.000...1.000	Power factor cos φ ¹⁾ Current-weighted avg. value of the power factor $\sum \frac{I_{rated\ i}}{I_{rated\ tot}} \cdot \cos \varphi_i$
P-018.M	Online	4	4.0...100.00 ms	Initial rounding-off Application-specific For motors with deep-bar squirrel-cage rotors: Increase parameter to approx. 30 ms
P-036.M	Online	4	0...7 hex	Inverter clock cycle frequency The current controller dynamic response is improved by increasing the switching frequency, however the permissible continuous current load capacity is reduced. Especially for high-speed motors, the switching frequency should be selected as high as possible, but the specified power de-rating must be maintained. If the switching frequency is changed, the current controller must be re-optimized.

1) Manufacturer's data according to VDE 0530, Part 1

2.3 Multi-motor operation

Parameter attributes			Setting range	Description
Number	Change effective	P-051		
P-159.M	Online	4	0.0...6535.5 gm ²	Moment of inertia, motor and external Application-specific Sum of the total moment of inertia referred to the motor shaft, the motor moment of inertia is calculated using P-153 = +1 Total moment of inertia is adjusted using P-204 = 5 and P-205 = +1
P-219.M	Online	4	0...15 kgm ²	Supplementary moment of inertia The parameterized value is internally added to P159.M. It is only necessary to make an entry in P-219.M, when the setting range of P-159.M is exceeded
P-166.M	Online	4	0...rated LT	No-load motor current Equivalent circuit diagram value Calculated using P-153 = +1 Adjusted using P-204 = 3 and P-205 = +1
P-167.M	Online	4	0.000...65.000 Ω	Motor stator resistance, cold Equivalent circuit diagram value Calculated using P-153 = +1
P-168.M	Online	4	0.000...65.000 Ω	Motor rotor resistance, cold Equivalent circuit diagram value Calculated using P-153 = +1 Adjusted using P-204 = 6 and P-205 = +1
P-169.M	Online	4	0.000...65.000 Ω	Stator leakage reactance Equivalent circuit diagram value Calculated using P-153 = +1
P-170.M	Online	4	0.000...65.000 Ω	Leakage rotor reactance Equivalent circuit diagram value Calculated using P-153 = +1
P-171.M	Online	4	0.00...650.00 Ω	Magnetizing reactance Equivalent circuit diagram value Calculated using P-153 = +1 Adjusted using P-204 = 4 and P-205 = +1
P-175.M	Online	4	0.0...500.0 min	Thermal motor time constant Manufacturer data Lowest time constant of the motor group An external individual monitoring is recommended. Refer to Section 2.2.3
P-172.M	Online	4	0...32000 RPM	Changeover speed, cl.-loop/open-loop control Calculated using P-153 = +1

Parameter attributes			Setting range	Description
Number	Change effective	P-051		
P-173.M	Online	4	0...32000 RPM	<p>Speed at the start of field weakening</p> <p>Calculated using P-153 = +1</p> <p>When operated from an uncontrolled supply and FW<2.00 the determined value must be multiplied by the factor ($V_{\text{supply}}/500V$) (corresponds to 0.8 for $V_{\text{supply}}=400V$).</p> <p>From FW2.00, the control algorithm is automatically adapted to the DC link voltage (P-006).</p> <p>The automatic adaptation can be disabled by resetting bit 2in P-090.</p>
P-176.M	Online	4	0...32000 RPM	<p>Speed at the start of the stall torque</p> <p>Calculated using P-153 = +1</p> <p>When operated from an uncontrolled supply and FW<2.00 the determined value must be multiplied by the factor ($V_{\text{supply}}/500V$) (corresponds to 0.64 for $V_{\text{supply}}=400V$).</p> <p>From FW2.00, the control algorithm is automatically adapted to the DC link voltage (P-006).</p> <p>The automatic adaptation can be disabled by resetting bit 2in P-090.</p>

2.3.2 Parameter set changeover

The induction motor module allows four complete motor data sets to be simultaneously saved. The actual data set can be selected using freely-programmable terminals (refer to Section 3.3.2) or using parameter P-056. If you wish to load various parameter sets into the induction motor module, then you can use these functions to changeover the parameter set. The currently valid motor data set is displayed in the first position at the left in the operating display (P-000, P-100).

If bit 1 = 1 in parameter P-053, then the motor data sets are also changed-over even when the pulses are enabled. This capability can be used to adapt the motor and controller data.

2.3.3 Motor changeover

The induction motor module allows four complete motor data sets to be simultaneously saved. The actual data set can be selected via freely-programmable terminals (refer to Section 3.3.2) or using parameter P-056. Freely-programmable relay functions are available for the four motor data sets (refer to Section 3.3.1), which indicate which of the data sets is active.

This function can be used to changeover the motor if you wish to operate various motors from the induction motor module one after the other.

In this case, bit 1 in parameter P-053 must be set to 0. This means, that after a request to changeover the motor, the motor data are only changed-over, if the induction motor module pulses are inhibited (refer to Section 1.3). The user can decide which enable terminals are used to inhibit the pulses. The pulse inhibit is interlocked for approx. 20 ms during changeover.

The interlock is then removed, and the "Motor ... active" relay of the newly loaded motor pulls-in. This relay signal can be used to control a contactor to changeover the motor. The currently valid motor data set is displayed at the first position to the left in the operating display (P-000, P-100).

A recommended circuit for the contactor control to changeover the motor is shown in the following diagram. The freely-programmable terminals Em with terminal function 20 "Motor selection bit 0" and En with the terminal function 21 "Motor selection bit 1" and the freely-programmable relay outputs Aw, Ax, Ay, Az, with relay functions 11, 12, 13, 14 are assigned "Motor 1, 2, 3, 4 active". The relays are mutually interlocked using the induction motor module software. However, the recommended contactor interlocking ensures that even for parameterizing errors, not more than one motor is connected to the drive converter at any one time.

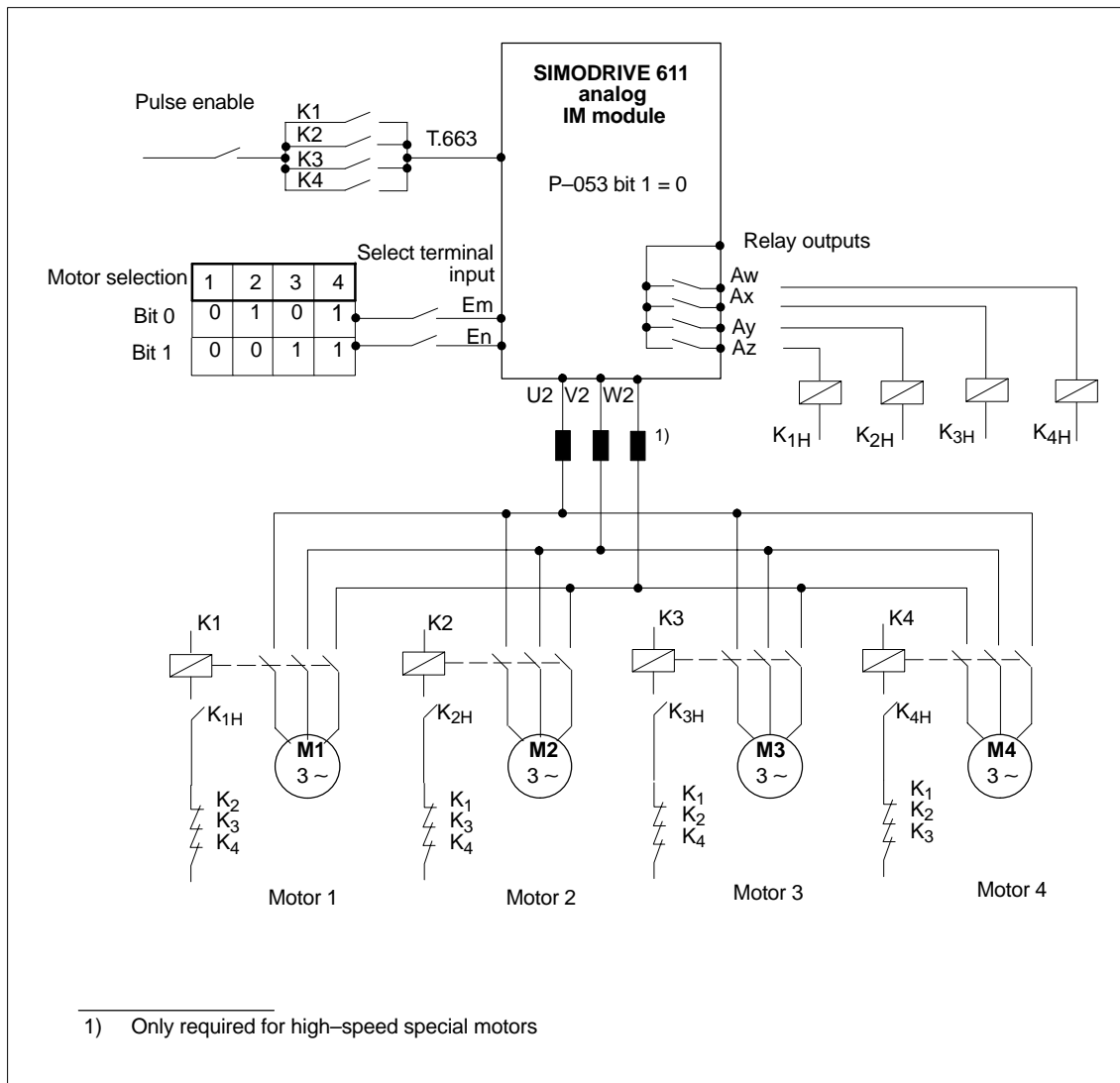

Fig. 2-2 Motor changeover

AM

2.4 Operating motors with maximum speeds > 32000 RPM



Pulse number P131

Warning

All parameters, which physically represent a speed with the units RPM, as well as BERO pulse number P131 are entered or displayed lower by the following factors:

Max. motor speed	Factor
32000...64000 RPM	1/2
> 64000 RPM	1/3

Parameter settings

In order to be able to operate motors with a maximum motor speed > 32000 RPM, the settings, shown in Table 2–13, must be made.

2.4 Operating motors with maximum speeds > 32000 RPM

Table 2-15 Operating motors with maximum speeds >32000 RPM

Parameter attributes			Setting range	Description	
Number	Change effective	P-051			
P-163.M	Online	4	0...64000 RPM	Rated motor speed ¹⁾ Non-synchronous speed at rated frequency and rated load $n_{rated} < (f_{rated} \cdot 60 \text{ s/min})/p$	
				Max. motor speed	Input
				32000...64000 RPM > 64000 RPM	Rated motor speed / 2 Rated motor speed / 3
P-174.M	Online	4	0...64000 RPM	Max. motor speed ¹⁾	
				Max. motor speed	Input
				32000...64000 RPM > 64000 RPM	Max. motor speed / 2 Max. motor speed / 3
P-153	Online	4	-1 ... 1 dec	Calculating the equivalent circuit diagram of the actual motor +1 is entered for pulse inhibit, terminal 63 or terminal 663 The calculations for the entered special motor are started. The following equivalent circuit diagram data are calculated:	
				Max. motor speed	Equivalent circuit diagram data
				32000...64000 RPM > 64000 RPM	P-159: Moment of inertia, motor and external . 4 P-159: Moment of inertia, motor and external . 9
P-153	Online	4	-1 ... 1 dec	Calculating the controller data of the actual motor -1 is entered for pulse inhibit, terminal 63 or terminal 663 The calculations for the entered special motor are started. The following controller data are calculated:	
				Max. motor speed	Controller data
				32000...64000 RPM > 64000 RPM	P-114: Speed for max. motor useful speed . 1/2 P-029: Speed limiting . 1/2 P-172: Changeover speed, open-loop/closed-loop control . 1/2 P-173: Speed at the start of field weak. . 1/2 P-176: Speed at the start of stall torque . 1/2 P-114: Speed for max. motor useful speed . 1/3 P-029: Speed limiting . 1/3 P-172: Changeover speed, open-loop/closed-loop control . 1/3 P-173: Speed at the start of field weak. . 1/3 P-176: Speed at the stall torque . 1/3

If speed setting values are manually entered with the units RPM, **all** of the values must be multiplied by the factors 1/2 and 1/3.

1) Manufacturer's data according to VDE 0530, Part 1

2.5 Monitor function

The address contents (data in the RAM area) of the induction motor module can be read via parameters **P-249** to **P-251**.

Note

A list of all of the important measured quantities (RAM variables) and their addresses is provided in the Appendix (Section 6.5).

Table 2-16 Monitor function

Parameter attributes			Setting range	Description
Number	Change effective	P-051		
P-249	Online	10	0...FFFF hex	Segment, memory location monitor Segment address of a RAM location
P-250	Online	10	0...FFFF hex	Address, memory location monitor Offset address of a RAM location
(P-251)	–	–	0...FFFF hex	Value display, memory location monitor Contents of a RAM location



Parameterizing the Drive Converter Interfaces

3

3.1 Speed setpoint interfaces

Overview

- Speed setpoint channel selection
- Normalization, analog speed setpoint
- Fixed setpoints/motorized potentiometer setpoint
- Setpoint priority

Speed setpoint channel selection

Table 3-1 Speed setpoint channel selection

Parameter attributes			Setting range	Description
Number	Change effective	P-051		
P-113	Online	4	0...9 hex	Channel selection, speed setpoint 0H: digital setpoint 0 1H: analog setpoint, channel 1, terminal 56/14 2H: analog setpoint, channel 2, terminal 24/8 3H: analog setpoint, sum channel 1 + channel 2, terminal 56/14 + terminal 24/8 4H: digital setpoint from the oscillation generator 6H: digital setpoint from the electronic mot. pot. 9H: sum, analog setpoint + fixed setpoint, channel 1 + fixed setpoint from the freely-programmable terminal function 17, 18, 19, 24 (10)H: digital setpoint; internally entered by the firmware during auto-optimization

3.1 Speed setpoint interfaces

Normalization, analog speed setpoint

Table 3-2 Normalization, analog speed setpoint

Parameter attributes			Setting range	Description
Number	Change effective	P-051		
P-014.M	Online	4	-32000...32000 RPM	Speed for max. useful motor speed Speed, which should be achieved with the analog input voltage in P-024 (channel 1 active) and in P-025 (channel 2 active). P-014 > 0 = clockwise rotating field for a positive speed setpoint P-014 < 0 = counter-clockwise rotating field for a positive speed setpoint
P-024	Online	4	2...10 V	Normalization, setpoint channel 1 Analog speed setpoint voltage for P-014
P-015	Online	4	E000...2000 hex	Offset correction, setpoint channel 1 e. g. pos. offset correction: 002FH neg. offset correction: FF00H
P-025	Online	4	2...10 V	Normalization, setpoint channel 2 Analog speed setpoint voltage for P-014
P-019	Online	4	E000...2000 hex	Offset correction, setpoint channel 2 e. g. pos. offset correction: 002FH neg. offset correction: FF00H

Fixed setpoints, motorized potentiometer setpoint

Table 3-3 Fixed setpoints, motorized potentiometer setpoint

Parameter attributes			Setting range	Description
Number	Change effective	P-051		
P-114.F	Online	4	-32000...32000 RPM	Fixed setpoints, 1 to 7 Permanently set speed setpoint Selected via the freely-programmable terminal function 17, 18, 19 (refer to Section 3.2.2).
P-119.F	Online	4	-32000...32000 RPM	Fixed setpoints, 8 to 15 Permanently set speed setpoint Selected via the freely-programmable terminal function 17, 18, 19, 24 (refer to Section 3.2.2) from FW 2.00
P-114.8	Online	4	-32000...32000 RPM	Motorized potentiometer setpoint Adjustable speed setpoint Selected via the freely-programmable terminal function 14, 15 (refer to Section 3.2.2).

Setpoint priority

Table 3-4 Setpoint priority

Priority	Setpoint	Setpoint source		Effect	
		Selected by	Designation		
High	$I_{mot} = 0$	T.63 or T.663	Open	Pulse enable inhibited	Motor coasts down in a no-current condition
	$n = 0$	T.81	Open	Fast ramp-function generator stop	Braking without ramp-down time, pulse enable or pulse inhibit
	$n = 0$	T.64 or T.65	Open	Controller enable inhibited	Braking with ramp-down time, pulse inhibit
	$n = 0$	T. fct. 16	Open	Setpoint enable inhibited	Braking with ramp-down time, pulse enable
	$n \geq n_{min}$	P-030	Value entry	Steady-state minimum speed	Min. speed, also for lower setpoints, lower priority
	$n \neq \Delta n$	P-054 P-055	Value entry	Speed range suppression	No steady-state operation in the suppressed speed range
	$n = +n/-n$	T. fct. 12	Activated	Clockwise/counter-clockwise rotating field	Only one direction of rotation possible
	$n = P-114.8$	P-113 = 6	Value entry	Motorized potentiometer function	Increase/decrease setpoint
	$n1 = P-154$ $n2 = P-155$	T. fct. 2	Controlled	Oscillation	Oscillation mode
	$n1 = P-114.1$ to $n7 = P114.7$ $n8 = P-119.1$ to $n15 = P-119.8$	T. fct. 17 T. fct. 18 T. fct. 19 T. fct. 24	Controlled	Fixed setpoint	Selected fixed speed
Low	Standard setpoint source	P-113	Value entry	Standard setpoint	Parameterized standard setpoint

3.2 Input terminals

3.2.1 Permanently-connected terminal functions



Warning

When the motor pulses are canceled, there is no longer any information about the motor speed. The calculated speed actual value is then set to 0. This means that all of the speed actual value signals, speed actual value messages and relay signals, which monitor the speed ($|n_{act}| < n_{min}$, ramp-up completed, $n_{act} < n_x$, $|n_{act}| = n_{set}$) no longer provide any meaningful information when the motor pulses are canceled. The motor pulses can be canceled by withdrawing enable signals or as a result of fault messages.



Warning

If a drive is shutdown using a fast ramp-function generator stop (terminal 81 open), and is kept at zero speed for a longer period of time with the inverter enabled, it should be ensured that the motor is adequately cooled, as a current is impressed which is in the order of a magnitude of the rated current (percentage in P-057).

Caution for self-ventilated motors.

Table 3-5 Permanently-connected terminal function

Terminal function	Description	Terminal number
Axis-specific pulse enable	The inverter is enabled (motor control) if the enable voltage is connected to terminal 663 (axis-specific pulse enable) and terminal 65 (controller enable). If terminal 663 (axis-specific pulse enable) is de-energized while the motor is rotating, the inverter is inhibited after 20 ms and the motor coasts down in a no-current condition.	663
Controller enable	If terminal 65 (controller enable) is de-energized while the motor is rotating, the drive brakes along the ramp-function generator ramp. When the n_{min} threshold (P-022) is fallen below (absolute value), the inverter is inhibited and the motor is shutdown so that it does not rotate backwards.	65
Fast ramp-function generator stop	If terminal 81 (fast ramp-function generator stop) is energized, the speed setpoint is enabled. If the input is open-circuit, a speed setpoint of zero (digital) is entered. If terminal 81 is de-energized while the motor is rotating, the motor brakes without ramp-function generator along the effective limit (current limiting P-057...P-059, torque limiting P-039, P-041, power limiting P-060). When zero speed is reached, the current from P-057 is still impressed. If bit 2 is set in P-053, then after the speed in P-022 is fallen below, the pulses are inhibited and the motor is switched-into a no-current condition.	81

Note

When starting a motor, the enable signals must be entered step-by-step in the sequence of their priority (refer to Table 3-5).

3.2.2 Freely-programmable terminal functions



Warning

Terminal function parameters P-081 to P-089 may only be programmed when the pulses are canceled (terminal 63 or terminal 663 open circuit).

Overview

- Terminal function assignment
- Terminal functions

Terminal function assignment

Table 3-6 Terminal function assignment

Parameter attributes			Setting range	Description
Number	Change effective	P-051		
P-081 bis P-089	Online	4	1...24 dec	Terminal function assignment E1 to E9 Functions 1 to 24 are assigned to terminals E1 to E9 by entering the function number. The factory setting should be taken from the following table.

3.2 Input terminals

Terminal functions

Table 3-7 Terminal functions

Terminal function	Description															Fct. No.	Assignment after initialization			
2nd torque limit	If this function is selected, the 2nd torque limit in P-041 becomes active if the changeover speed from P-050 is exceeded.															1	P-081 (E1)			
Oscillation	If this function is selected, then the speed setpoint of the oscillation generator from P-154 to P-157 becomes active.															2				
Reset fault memory (R) fault acknowledgement	If this function is selected, with the controller inhibited (terminal 65 or terminal 663 open-circuit), a fault message, when available, is acknowledged.															3	P-083 (E3)			
Ramp-up time=0	If this function is selected, the internal ramp-function generator is bypassed.															7	P-082 (E2)			
Gearbox stage	1	2	3	4	5	6	7	8	A total of 8 binary-coded parameter sets for setpoint normalization, speed monitoring, controller setting, torque limiting and torque monitoring can be selected.											
Bit 0	0	1	0	1	0	1	0	1								9	P-087 (E7)			
Bit 1	0	0	1	1	0	0	1	1								10	P-088 (E8)			
Bit 2	0	0	0	0	1	1	1	1								11	P-089 (E9)			
Clockwise/counter clockwise	If this function is activated, only positive setpoints are permitted; negative setpoints result in speed n=0. If the appropriate terminal is energized, only counter-clockwise direction of rotation is output, otherwise only the clockwise rotating field.															12				
Ramp-function generator 2	If this function is selected, the 2nd parameter set P-042 and P-043 of the internal ramp-function generator is activated.															13				
Increase setpoint	Motorized potentiometer function P-113=6 If one of these terminals is energized, the digital speed setpoint P-114.8 of the motorized potentiometer function is increased or decreased corresponding to the ramp-up or ramp-down times of ramp-function generator 2 (with the exception TH=0). If both are simultaneously controlled, the setpoint is changed towards 0.															14				
Decrease setpoint																15				
Setpoint enable	If this function is activated, the appropriate terminal must be energized in order to move the drive. If the terminal is opened, the drive brakes with the appropriate ramp-down time and comes to a standstill under current.															16				
Fixed setpoint selection	0	1	2	3	4	5	6	7	8	9	10	11	12	13	14	15	A total of 15 binary coded fixed values P-114.1 to P-114.7 and P-119.1 to P-119.8 are selected using this terminal. If all of the terminals remain open-circuit, the setpoint, defined in P-113, is valid.			
Bit 0	0	1	0	1	0	1	0	1	0	1	0	1	0	1	0	1			17	P-084 (E4)
Bit 1	0	0	1	1	0	0	1	1	0	0	1	1	0	0	1	1			18	P-085 (E5)
Bit 2	0	0	0	0	1	1	1	1	0	0	0	0	1	1	1	1			19	P-086 (E6)
Bit 3	0	0	0	0	0	0	0	0	1	1	1	1	1	1	1	1			24	
Motor selection	1	2	3	4	A total of 4 binary-coded motor data sets, motor 1 to motor 4 can be selected using these terminals.															
Bit 0	0	1	0	1												20				
Bit 1	0	0	1	1												21				

3.3 Output terminals



Warning

When the motor pulses are canceled, there is no longer any information about the motor speed. The calculated speed actual value is then set to 0. This means that all of the speed actual value signals, speed actual value messages and relay signals, which monitor the speed ($|n_{act}| < n_{min}$, ramp-up completed, $n_{act} < n_x$, $|n_{act}| = n_{set}$) no longer provide any meaningful information when the motor pulses are canceled. The motor pulses can be canceled by withdrawing enable signals or as a result of fault messages.



Caution

All of the relays drop-out when the electronics power supply fails or is powered-down.

3.3.1 Permanently-connected relay functions

Table 3-8 Permanently-connected relay functions

Terminal function	Description			Terminal number
Ready/no fault, axis-specific	The relay function can be changed-over using P-053:			672 673 674
	Bit	Value		
	0	0000H 0001H	The relay pulls-in if there is no fault and the pulses and controller are enabled. The relay pulls-in if there is no fault present.	
Feedback signal, start inhibit	The relay (NC contact) pulls-in if the enable voltage is connected to terminal 663, axis-specific pulse enable.			AS1 AS2

3.3.2 Freely-programmable relay functions



Warning

Relays (P-241 to P-247) may only be programmed when the pulses are inhibited (terminal 63 or terminal 663 open-circuit).

Overview

- Message assignment
- Relay functions
- Messages which can be parameterized
- Control word, messages

Note

The relay signals are updated with 20 ms for the standard speed controller clock cycle.
 For a faster speed controller clock cycle, they are updated with 10 ms (refer to P-090, bit 3, FW 3.00).

Message assignment

Table 3-9 Message assignment

Parameter attributes			Setting range	Description
Number	Change effective	P-051		
P-241 to P-246	Online	4	1...20 dec	Programmable messages 1 to 6 Functions 1 to 20 are assigned to relay outputs A11 to A61 by entering the function number. The factory setting can be taken from the following table.

Relay functions

Table 3-10 Relay functions

Relay function	Description	Funct. No.	Relay output, when supplied
$ n_{act} < n_{min}$	The relay pulls-in if the calculated speed falls below the actual value set in P-021.1 to P-021.8.	1	A31 (P-243)
Ramp-up completed	The relay pulls-in if, after the setpoint step, the calculated speed actual value is within the actual tolerance bandwidth around the new setpoint, and has remained for at least 200 ms in this tolerance bandwidth. The "Ramp-up completed" relay remains inactive if the tolerance bandwidth is left again before the 200ms has expired. The tolerance bandwidth is set using P-027.1 to P-027.8. The signal stays in the active position until the speed setpoint changes. If the tolerance bandwidth is left again after 200 ms, the signal remains active, unless, in the meantime, the setpoint has changed. Speed fluctuations caused by load changes do not cause the relay to drop-out.	2	A61 (P-246)
$ M_d < M_{dx}$	The relay pulls-in, if the torque falls below the actual limit value. The limit value is set using P-047.1 to P-047.8. If relay $n_{act}=n_{set}$ drop-out when the speed setpoint changes, the $ M_d < M_{dx}$ relay can only drop-out 800 ms after relay $n_{act} = n_{set}$ has pulled-in again.	3	A21 (P-242)
$ n_{act} < n_x$	The relay pulls-in, if the speed falls below the n_x threshold. n_x is set using P-023.1 to P-023.8.	4	A41 (P-244)
I^2t pre-alarm	The relay drops-out if the actual thermal motor model is overloaded. The thermal time constants are separately set for each motor in P-175.1 to P-175.4. The user can define how he responds to this pre-alarm. Fan function and air intake temperature are not taken into account. Thus, it is preferable to use a temperature sensor.	5	A51 (P-245)
Drive converter overtemp. pre-alarm	The relay drops-out if the main heatsink temperature monitoring responds. If the overtemperature condition continues, the drive converter is powered-down after approx. 20 s with the fault message F-15.	6	–
Variable relay function 1	Refer to the description of the "Variable relay functions".	7	–
Variable relay function 2	Set using P-185 to P-189 and using P-190 to P-194.	8	–
	Reserved	9	–
	Reserved	10	–
Motor 1 active	One of these relays pulls-in if the appropriate motor data set is active. Using this relay function, the external auxiliary contactor can be controlled to changeover the motor .	11	–
Motor 2 active		12	–
Motor 3 active	We recommend a mutual contactor interlocking and an interlocking with the pulse enable.	13	–
Motor 4 active		14	–
Motor overtemp. pre-alarm	The relay drops-out when the motor develops an overtemperature condition. If the fault condition continues, the drive converter is powered-down with fault message F-14 after a time set in P-065. (from FW 3.00)	16	–
$n_{act} = n_{set}$	The relay pulls-in if the calculated speed actual value enters the tolerance bandwidth around the setpoint before the RFG and remains for at least 200 ms in this tolerance bandwidth P-027.1 to P027.8 are used to set this tolerance bandwidth. If the tolerance bandwidth is left, relay " $n_{act} = n_{set}$ " immediately drops-out. The relay drops-out as a result of speed fluctuations caused by load changes.	20	A11 (P-241)

3.3 Output terminals

Parameterizable signals

Table 3-11 Parameterizable signals

Parameter attributes			Setting range	Description
Number	Change effective	P-051		
P-021.G	Online	4	2...16000 RPM	n_{min} for "n_{act} < n_{min}" signal Response value for freely-programmable relay signal 1 " $ n_{act} < n_{min}$ "
P-023.G	Online	4	0...32000 RPM	n_x for "n_{act} < n_x" signal Response value for freely-programmable relay signal 4 " $ n_{act} < n_x$ "
P-027.G	Online	4	0...29000 RPM	Tolerance bandwidth for "n_{set} = n_{act}" signal Tolerance value for freely-programmable relay signal 1 "Ramp-up completed" and for the freely-programmable relay signal 20 " $n_{set} = n_{act}$ "
P-047.G	Online	4	0...100 %	M_{dx} for "M_d < M_{dx}" signal Response value for the freely-programmable relay signal 3 " $M_d < M_{dx}$ " The setting refers to the actual torque limiting.

Control word, signals

Table 3-12 Control word, signals

Parameter attributes			Setting range	Description		
Number	Change effective	P-051		Bit	Value	
P-247	Online	4	0...FFFF hex	Control word, signals		
				Each of the relay signals can be individually and independently inverted by setting the appropriate bit.		
				0	0001H	Relay function terminal A11 is inverted
				1	0002H	Relay function terminal A21 is inverted
				2	0004H	Relay function terminal A31 is inverted
				3	0008H	Relay function terminal A41 is inverted
				4	0010H	Relay function terminal A51 is inverted
				5	0020H	Relay function terminal A61 is inverted

3.3.3 Variable relay function

Table 3-13 Variable relay function

Parameter attributes			Setting range	Description		
Number	Change effective	P-051				
P-185 to P-189	–	–	–	Variable relay function 1		
P-185	Online	4	0...FFFF hex	Address for monitoring 1		
P-186	Online	4	0...FFFF hex	Threshold for monitoring 1		
P-187	Online	4	0.00...10.00 s	Pull-in delay, monitoring 1		
P-188	Online	4	0.00...10.00 s	Drop-out delay, monitoring 1		
P-189	Online	4	0...7FFF hex	Hysteresis, monitoring 1 Hysteresis for threshold P-186		
P-190 to P-194	–	–	–	Variable relay function 2		
P-190	Online	4	0...FFFF hex	Address for monitoring 2		
P-191	Online	4	0...FFFF hex	Threshold for monitoring 2		
P-192	Online	4	0.00...10.00 s	Pull-in delay, monitoring 2		
P-193	Online	4	0.00...10.00 s	Drop-out delay, monitoring 2		
P-194	Online	4	0...7FFF hex	Hysteresis, monitoring 2 Hysteresis for threshold P-191		
P-247	Online	4	0...FFFF hex	Control word, signals		
				Bit	Value	
				8	0000H	Variable relay function 1 with sign interrogation
					0100H	Variable relay function 1 with absolute value interrogation
				9	0000H	Variable relay function 2 with sign interrogation
0200H	Variable relay function 2 with absolute value interrogation					
12	0000H	Variable relay function 1 with P-186 as threshold				
	1000H	Variable relay function 1 as bit test. The threshold (P-186) is AND'ed with the RAM variable (P-185) to be monitored.				
13	0000H	Variable relay function 2 with P-191 as threshold				
	2000H	Variable relay function 2 as bit test				

Note

A list of the important measured quantities (RAM variables) and their addresses are provided in the Attachment (Section 6.5).

3.3.4 Analog outputs

Note

Analog outputs are not possible with Order No. [MLFB] 6SN1122-0BA11-0AA0.

Overview

- Function
- Technical data
- Parameterization DAU 1, DAU 2
- Connection for analog displays

Function

Analog output of RAM variables for measurement purposes using two 8-bit D/A converters.

Note

A list of the important measured quantities (RAM variables) and their addresses are provided in the Attachment (Section 6.5).

Technical data

- 2 output channels at terminal A91 (DAU 1) and terminal A92 (DAU 2)
- ± 10 V voltage range
- Coarse and fine normalization, offset compensation
- Polarity of the output voltage can be set using the fine normalization (± 1000 %)

Parameterization DAU 1, DAU 2

Table 3-14 Parameterization DAU 1, DAU 2

Parameter attributes			Setting range	Description
Number	Change effective	P-051		
P-066	Online	4	0...FFFF hex	Address, DAU 1 Address of the RAM variables which are to be output at DAU 1 Default: 11B6H absolute calculated speed actual value
P-067	Online	4	0...F hex	Shift factor, DAU 1 Coarse normalization of the selected data value by shifting the binary number to the left. Shift to the left by 1 = multiplication by 2 Max. gain: 32768
P-012	Online	4	-1000.0...1000.0 %	Normalization, DAU 1 Fine normalization of the selected data value
P-078	Online	4	-127...127 dec	Offset, DAU 1 Compensation of a possibly existing offset for DAU 1
P-068	Online	4	0...FFFF hex	Address, DAU 2 Default: 11B8H utilization
P-069	Online	4	0...F hex	Shift factor, DAU 2
P-013	Online	4	-1000.0...1000.0 %	Normalization, DAU 2
P-079	Online	4	-127...127 dec	Offset, DAU 2

Output voltage [V]

Hex numerical value

— Shift factor = 0 Offset = 0 V
 - - - Shift factor = 2 Fine normalization = 100 %

3.3 Output terminals

Connection for analog displays

Application: The following DAU assignment is intended to connect unipolar display instruments and the operating range is therefore limited to 0...+10 V without overflow.

Table 3-15 Connection for analog displays

Parameter attributes			Setting range	Description
Number	Change effective	P-051		
P-012	Online	4	-1000.0...1000.0	Normalization, DAU 1 P-066 = 11B6H n _{act} display For P-012 = 100 % and P-067 = 0H, the following is valid: Standstill = 0 V Max. speed (minimum from P-029, P-174) = +10 V 1 V corresponds to 10 %
P-013	Online	4	-1000.0...1000.0	Normalization, DAU 2 P-068 = 11B8H utilization Displays the utilization in the ranges constant torque: M_d/M_{dmax} constant power: P/P_{max} (takes into account the actual torque limits P-039, P-041 and the current and power limits P-059 and P-060) For P-013 = 100 % and P-069 = 0H, the following is valid: No load = 0 V Max. torque and power = + 10 V 1 V corresponds to 10 %

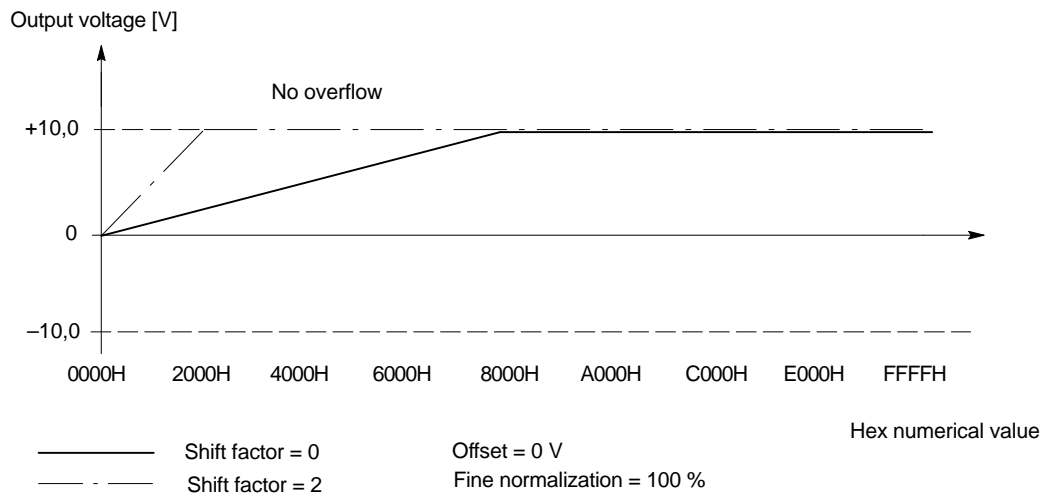

4

Controller Optimization

Automatic functions can be selected to adjust important motor parameters. The drive must be enabled.

**Warning**

With these automatic optimization runs, the motor is connected to a voltage and it operates at speeds up to the maximum speed. The optimization runs involved are identified by the  symbol.

Note

When using an UE module, in order to reduce the regenerative power, the ramp-down time P-017 and P-043 must be increased until the drive can brake from the maximum motor speed down to 0 without a fault message being output (DC link overvoltage).







Table 4-1 Controller optimization

Parameter attributes			Setting range	Description
Number	Change effective	P-051		
Optimizing the controller data of the actual motor with the drive enabled				
P-204	Online	10	0...8 dec	<ul style="list-style-type: none"> Current controller optimization, refer to Section 4.2 Enter 1 selection: Current controller optimization Enter 1 start optimization
P-205	Online		0...1 dec	
P-204	Online	10	0...8 dec	<ul style="list-style-type: none"> Adjust power offset ¹⁾ Enter 2 selection: Adjust power offset Enter 1 start adjustment
P-205	Online		0...1 dec	
P-031	Online	4	0.0...255.9	<ul style="list-style-type: none"> Speed controller optimization, refer to Sections 4.1 and 4.7 P gain, speed controller Integral action time, speed controller
P-032	Online	4	10.0...6000.0 ms	

1) No longer necessary from FW 3.0

4 Controller optimization

Tabelle 4-1 Controller optimization

Parameter attributes			Setting range	Description
Number	Change effective	P-051		
P-034	Online	4	0,0...600,0 A/V s	<ul style="list-style-type: none"> Field controller optimization, refer to Section 4.3 P gain, field controller Integral action time, field controller
P-035	Online	4	5.0...600.0 ms	
P-204	Online	10	0...8 dec	<ul style="list-style-type: none"> Adjust no-load current  Enter 3 selection: Adjust no-load current Enter 1 start adjustment
P-205	Online		0...1 dec	
P-204	Online	10	0...8 dec	<ul style="list-style-type: none"> Adjust magnetizing reactance  Enter 4 selection: Adjust the magnetizing reactance Enter 1 start adjustment
P-205	Online		0...1 dec	
P-204	Online	10	0...8 dec	<ul style="list-style-type: none"> Adjustment, field-weakening speed  (from FW 2.00) Enter 8 selection: Adjust the field-weakening speed Enter 1 start adjustment
P-205	Online		0...1 dec	
P-204	Online	10	0...8 dec	<ul style="list-style-type: none"> Adjustment, total moment of inertia  Enter 5 selection: Adjust the total moment of inertia Enter 1 start adjustment
P-205	Online		0...1 dec	
P-204	Online	10	0...8 dec	<ul style="list-style-type: none"> Adjust rotor resistance  (not applicable for motors with deep-bar squirrel-cage rotors) Enter 6 selection: Adjust rotor resistance Enter 1 start adjustment
P-205	Online		0...1 dec	
P-204	Online	10	0...8 dec	<ul style="list-style-type: none"> Calculate speed controller setting  (from FW 2.00) Not applicable, if the speed controller was optimized (refer to the previous text) Enter 7 selection: Calculate the speed controller setting Enter 1 start calculation
P-205	Online		0...1 dec	
P-052	Online	4	0...1 hex	Transfer parameters into the FEPROM

Note

If the no-load current adjustment is interrupted with F-60, then a possibly effective speed limit must be increased above the no-load speed.

If the adjustment was interrupted with F-60 due to voltage limiting, the operation can be repeated with a lower task value in P-166, or the DC link voltage can be increased to 625 V (refer to the NE module).

Note

In order to adjust the total moment of inertia, the ramp-up time P-016 and P-042 must be set to the lowest possible value (preferably to zero).

If the speed controller requires an integral action time P-032 > 250 ms, the total moment of inertia should be adjusted manually according to Section 4.7.

The ramp-down time P-017 and P-043 can be increased to reduce the regenerative power in combination with an UE module.

Note

If the motor shaft rotates while the current controller is being optimized, then the optimization point must be repeated and a speed setpoint of zero must be entered (e.g. using terminal 81 HSS).

4.1 Speed controller

Overview

- Ramp-function generator
- Gain, integral action time
- Speed controller adaptation
- Speed controller clock cycle
- Total moment of inertia

Ramp-function generator

Table 4-2 Ramp-function generator

Parameter attributes			Setting range	Description		
Number	Change effective	P-051				
P-016.M	Online	4	0.00...320.00 s	Ramp-up time, ramp-function generator 1 (from $n = 0$ to $n_{max} \rightarrow P-174$)		
P-017.M	Online	4	0.00...320.00 s	Ramp-down time, ramp-function generator 1 (from $n_{max} \rightarrow P-174$ to $n = 0$)		
P-042.M	Online	4	0.00...320.00 s	Ramp-up time, ramp-function generator 2 (from $n = 0$ to $n_{max} \rightarrow P-174$)		
P-043.M	Online	4	0.00...320.00 s	Ramp-down time, ramp-function generator 2 (from $n_{max} \rightarrow P-174$ to $n = 0$)		
P-018.M	Online	4	4.00...100.00 ms	Initial rounding-off Torque setpoint smoothing		
P-053	Online	4	0...FFFF hex	Control word		
				Bit	Value	
				3	0000H	The ramp-function generator is not tracked
0008H	The ramp-function generator is tracked					

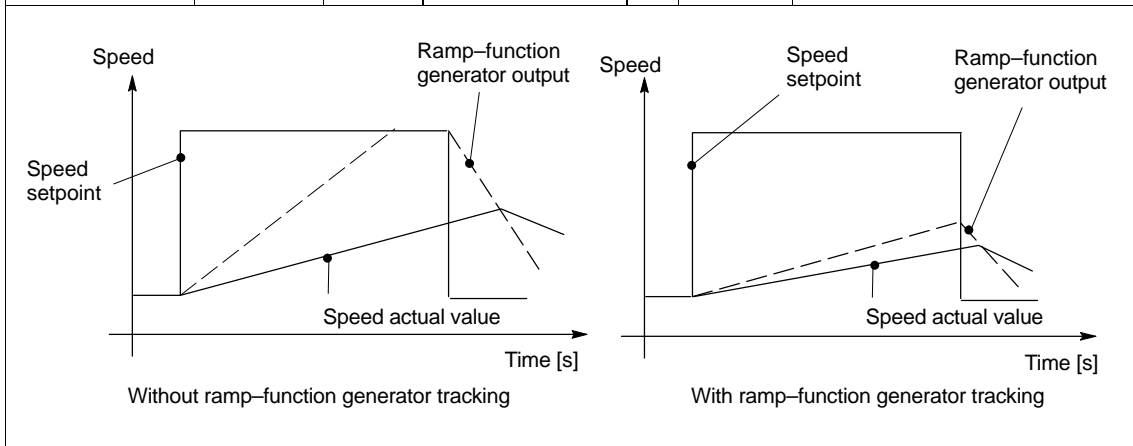

Gain, integral action time

Table 4-3 Gain, integral action time

Parameter attributes			Setting range	Description
Number	Change effective	P-051		
P-031.M	Online	4	0.0...255.9	P gain, speed controller
P-032.M	Online	4	10...6000 ms	Integral action time, speed controller

When calculating the controller data P-153 = -1, among other things, the speed controller parameters are determined.

In some cases, the control behavior can still be improved (refer to Section 4.7).

Speed controller adaptation

If another speed controller P gain is required in the upper speed range, the speed controller adaptation can be activated.

Table 4-4 Speed controller adaptation

Parameter attributes			Setting range	Description
Number	Change effective	P-051		
P-195.M	Online	4	0...32000 RPM	Lower adaptation speed
P-196.M	Online	4	0...32000 RPM	Upper adaptation speed
P-197.M	Online	4	0.0...255.9 dec	P gain, lower adaptation speed
P-198.M	Online	4	0.0...255.9 dec	P gain, upper adaptation speed
P-199.M	Online	4	1...150 %	P gain, reduction factor (the P gain characteristic is multiplied over the complete speed range)
P-203.M	Online	4	0...1 hex	Select speed controller adaptation 0: No adaptation P-031 effective 1: Speed contr. adapt. active P-031 ineffective

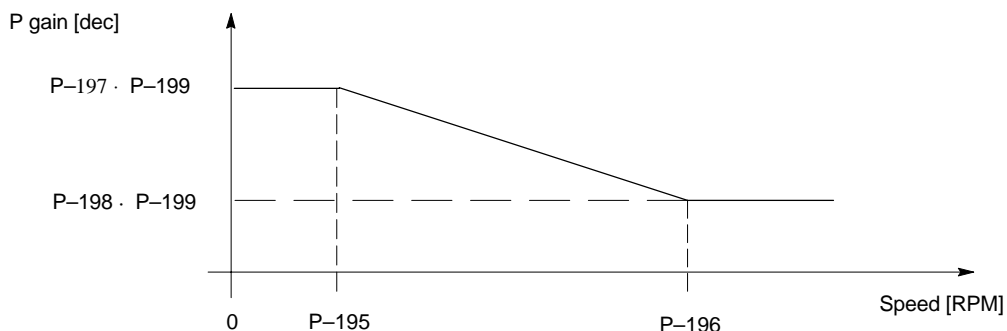

4.1 Speed controller

**Speed controller
clock cycle**

Table 4-5 Speed controller clock cycle

Parameter attributes			Setting range	Description		
Number	Change effective	P-051				
P-090		4	0...FFFFhex	Control word		
				Bit	Word	
				3	0000H 0008H	Sp. ctrl. clock cycle, standard Sp. ctrl. clock cycle, fast If bit 3 is changed, it only becomes effective after saving to FEPR0M and power on/off.

**Total moment of
inertia**

Table 4-6 Total moment of inertia

Parameter attributes			Setting range	Description	
Number	Change effective	P-051			
P-159.M	Online	4	0.0...6535.5 gm ²	Moment of inertia, motor and external Sum of the motor moment of inertia + external moment of inertia referred to the motor shaft	
P-219.M	Online	4	0...15 kgm ²	Additional moment of inertia The parameterized value is internally added to P-159.M. It is only necessary to enter in P-219.M if the setting range of P-159.M is exceeded (from FW 2.00)	

4.2 Current controller

Overview

- Current controller optimization
- No-load motor current

Current controller



Warning

The module can be destroyed if the current controller P gain P-115 or P-116 is set too high.

If the inverter clock cycle frequency is increased, then the de-rating, specified in Table 4-8 must be maintained.

Table 4-7 Current controller optimization

Parameter attributes			Setting range	Description																
Number	Change effective	P-051																		
P-036.M	Online	4	0...3 hex	<p>Inverter clock cycle frequency</p> <p>If the clock cycle frequency is increased, the current controller dynamic response is improved, but the permissible continuous current load capacity is reduced due to the switching losses.</p> <p>The clock cycle frequency-dependent current limit is displayed in parameter P-049 and represents the maximum drive converter current as a percentage regarding the instantaneous current.</p> <p>If the clock cycle frequency is changed, the current controller must be re-optimized.</p> <p style="text-align: center;">Inverter clock cycle frequency</p> <table style="margin-left: auto; margin-right: auto;"> <tr> <td>0</td><td>3.2 kHz</td><td>4</td><td>2.8 kHz</td></tr> <tr> <td>1</td><td>4.7 kHz</td><td>5</td><td>3.9 kHz</td></tr> <tr> <td>2</td><td>6.3 kHz</td><td>6</td><td>5.0 kHz</td></tr> <tr> <td>3</td><td>7.8 kHz</td><td>7</td><td>5.9 kHz</td></tr> </table>	0	3.2 kHz	4	2.8 kHz	1	4.7 kHz	5	3.9 kHz	2	6.3 kHz	6	5.0 kHz	3	7.8 kHz	7	5.9 kHz
0	3.2 kHz	4	2.8 kHz																	
1	4.7 kHz	5	3.9 kHz																	
2	6.3 kHz	6	5.0 kHz																	
3	7.8 kHz	7	5.9 kHz																	
(P-037)	–	–	2.8...7.8 kHz	Displays the actual inverter clock cycle frequency																
(P-049)	–	–	0...399 %	Current limiting with de-rating																

4.2 Current controller

Table 4-8 Currents as a function of the inverter clock cycle frequency, IM analog f_T

Power module type	Order Nos. 6SN1123-1AA0□- 6SN1123-1AA0□- 6SN1123-1AA0□-	Code No.	In / Is6 / I _{max} in A	In / Is6 / I _{max} in A	In / Is6 / I _{max} in A	In / Is6 / I _{max} in A
			f_T :3.2kHz	f_T :4.7kHz	f_T :6.3kHz	f_T :7.8kHz
8A	-0HA□	1	3 / 3 / 3	2.5 / 2.5 / 2.5	2 / 2 / 2	1.6 / 1.6 / 1.6
15A	-0AA□	2	5 / 5 / 8	4.2 / 4.2 / 6.8	3.4 / 3.4 / 5.4	2.6 / 2.6 / 4.2
25A	-0BA□	4	8 / 10 / 16	6.9 / 8.6 / 13.8	5.7 / 7.1 / 11.4	4.6 / 5.7 / 9.1
50A	-0CA□	6	24 / 32 / 32	20 / 26 / 26	15 / 20 / 20	10 / 14 / 14
80A	-0DA□	7	30 / 40 / 51	26 / 34 / 44	21 / 28 / 36	17 / 23 / 29
108A	-0LA□	13	45 / 60 / 76	39 / 52 / 65	32 / 43 / 54	26 / 34 / 43
120A	-0GA□	8	45 / 60 / 76	39 / 52 / 65	32 / 43 / 54	26 / 34 / 43
160A	-0EA□	9	60 / 80 / 102	51 / 68 / 86	41 / 54 / 69	31 / 42 / 53
200A	-0FA□	10	85 / 110 / 127	73 / 95 / 109	60 / 78 / 90	48 / 63 / 72
300A	-0JA□	11	120 / 150 / 193	101 / 127 / 163	81 / 102 / 131	62 / 78 / 101
400A	-0KA□	12	200 / 250 / 257	169 / 211 / 217	135 / 169 / 174	104 / 130 / 134
			From FW 3.00			
Power module type	Order Nos. 6SN1123-1AA0□- 6SN1123-1AA0□- 6SN1123-1AA0□-	Code No.	In / Is6 / I _{max} in A	In / Is6 / I _{max} in A	In / Is6 / I _{max} in A	In / Is6 / I _{max} in A
			f_T : 2.8kHz	f_T : 3.9kHz	f_T : 5.0kHz	f_T : 5.9kHz
8A	-0HA□	1	3 / 3 / 3	2.8 / 2.8 / 2.8	2.4 / 2.4 / 2.4	2.2 / 2.2 / 2.2
15A	-0AA□	2	5 / 5 / 8	4.6 / 4.6 / 7.4	4.1 / 4.1 / 6.5	3.6 / 3.6 / 5.8
25A	-0BA□	4	8 / 10 / 16	7.5 / 9.3 / 15	6.7 / 8.3 / 13.3	6 / 7.5 / 12
50A	-0CA□	6	24 / 32 / 32	22 / 29 / 29	19 / 25 / 25	16 / 21 / 21
80A	-0DA□	7	30 / 40 / 51	28 / 37 / 48	25 / 33 / 42	22 / 30 / 38
108A	-0LA□	13	45 / 60 / 76	42 / 56 / 71	37 / 50 / 63	34 / 45 / 57
120A	-0GA□	8	45 / 60 / 76	42 / 56 / 71	37 / 50 / 63	34 / 45 / 57
160A	-0EA□	9	60 / 80 / 102	56 / 74 / 95	49 / 65 / 83	43 / 58 / 73
200A	-0FA□	10	85 / 110 / 127	79 / 103 / 119	71 / 91 / 106	63 / 82 / 95
300A	-0JA□	11	120 / 150 / 193	111 / 139 / 179	98 / 122 / 157	86 / 108 / 139
400A	-0KA□	12	200 / 250 / 257	185 / 232 / 238	163 / 203 / 209	144 / 180 / 185

P-115.M	Online	4	0...255 dec	P gain, controller controller, base speed range
P-116.M	Online	4	0...300 dec	P gain, current controller, field-weakening range

$$P116.M = 255 - (255 - P115.M) \cdot \frac{P173.M}{P174.M}$$

No-load motor current

Table 4-9 No-load motor current

Parameter attributes			Setting range	Description
Number	Change effective	P-051		
P-166.M	Online	4	0.00...I _{rated} LT	No-load motor current Motor rotating without any connected load

4.3 Field controller

Gain, integral action time

Table 4-10 Gain, integral action time

Parameter attributes			Setting range	Description
Number	Change effective	P-051		
P-034.M	Online	4	0.0...600,0 100 A/Vs	P gain, field controller
P-035.M	Online	4	5.0...600.0 ms	Integral action time, field controller

When calculating the controller data P-153 = -1, among other things, the field controller parameters are determined.

In several cases, the control behavior can be further improved (refer to Section 4.7)

4.4 Optimization, open-loop controlled range



Warning

If a drive is operated for a longer period of time in the open-loop speed controlled range, adequate motor cooling must be guaranteed, as a current is impressed in the motor which is approximately the same as the rated current (percentage in P-057).

Caution for self-ventilated motors.

Table 4-11 Optimization, open-loop controlled range

Parameter attributes			Setting range	Description
Number	Change effective	P-051		
P-057.M	Online	4	0...150 %	Current setpoint for the open-loop controlled range Percentage of the rated motor current Current setpoint for the current-Hz open-loop control
P-058.M	Online	4	0...399 %	Accelerating torque in the open-loop controlled range Percentage of the rated motor torque
P-172.M	Online	4	0...32000 RPM	Changeover speed, open-loop/closed-loop control The changeover is realized with a hysteresis of 200 RPM.

Note

If the maximum available drive converter current is limited in the acceleration phase, the torque-generating component is also reduced.

In this case, the ramp-up time is shortened by reducing the current in P-057.

4.5 Limits

Table 4-12 Limits

Parameter attributes			Setting range	Description
Number	Change effective	P-051		
P-174.M	Online	4	0...32000 RPM	Max. motor speed Highest permissible motor speed
P-059.M	Online	4	0...399 %	Current limiting Percentage of the rated motor current
P-060.M	Online	4	0...399 %	Power limiting Percentage of the rated motor power
P-029.G	Online	4	0...32000 RPM	Speed limiting Highest required motor speed
P-039.G	Online	4	0...399 %	1st torque limit value Percentage of the rated motor torque
P-041.G	Online	4	0...399 %	2nd torque limit value Percentage of the rated motor torque Selected using the freely-programmable terminal function 1. Changeover, if the actual switching speed from M_{d1} to M_{d2} P-050 is exceeded.
P-050.G	Online	4	0...32000 RPM	Switching speed, from M_{d1} to M_{d2} Switching condition for the limit value changeover

Note

If a drive is to be operated in the overload range, the limits may only be increased **after** the controller has been optimized.

The various limits are always simultaneously taken into account.

If an overload condition is to be permitted, then generally, more than one limit has to be increased.

If the ramp-up time (acceleration time) is to be shortened, then it is practical to also change the open-loop controlled range.

4.6 Special speeds and speed range

Overview

- Steady-state minimum speed
- Speed range suppression
- Shutdown without reverse rotation

Steady-state minimum speed

Table 4-13 Steady-state minimum speed

Parameter attributes			Setting range	Description
Number	Change effective	P-051		
P-030.M	Online	4	0...32000 RPM	<p>Steady-state minimum speed No steady-state operation in the speed range around zero. The range is passed through with the actual ramp-up or ramp-down times if the speed setpoint exceeds the steady-state minimum speed in the opposite direction of rotation. Zero speed can only be forced by inhibiting the permanently-connected enable signals or the freely-programmable terminal function 16, setpoint enable.</p>

Effective setpoint [RPM]

Steady-state min. speed
(P-030 < 200 RPM)

Entered setpoint [RPM]

Effective setpoint [RPM]

Steady-state min. speed
(P-030 > 200 RPM)

Entered setpoint [RPM]

Speed range suppression

Table 4-14 Speed range suppression

Parameter attributes			Setting range	Description
Number	Change effective	P-051		
P-054.M P-055.M	Online Online	4 4	0...32000 RPM 0...32000 RPM	Range suppression, lower speed Range suppression, upper speed No steady-state operation in the suppressed speed range. The range is passed through with the actual ramp-up or ramp-down times if the speed setpoint violates the other transition (corner) speed.

Shutdown without reverse rotation

Table 4-15 Shutdown without reverse rotation

Parameter attributes			Setting range	Description
Number	Change effective	P-051		
P-022.M	Online	4	2...32000 RPM	Shutdown speed, pulse cancellation Shutdown without reverse rotation With the controller inhibited, when the shutdown speed is fallen below, the motor is switched into a no-current condition in order to prevent it overshooting when approaching zero speed.

4.7 Manual optimization

Overview

- Current controller
- Speed controller
- Field controller
- No-load motor current
- Magnetizing reactance
- Moment of inertia, motor and external
- Motor rotor resistance

If the system has to be manually optimized, the specified signals must be plotted using a storage oscilloscope at the appropriate test points, and the parameters set so that the required signal characteristics and behavior are obtained. The operation can be triggered using the first specified signals.

For several adjustments, the settling behavior after setpoint steps is evaluated (using the ramp-up time P-016 and P-042 = 0) (step response). These can be entered using the oscillation generator (refer to Section 2.2.3). The braking energy can be regenerated into the line supply when an I/O module is used. When UE modules are used, this energy is converted into heat.

The ramp-down time P-017 and P-043 can be increased to reduce the braking power.

Current controller

P-115, P gain, current controller, base speed range

P-116, P gain, current controller, field-weakening range

Table 4-16 Test socket parameterization

Signal name	Test point	Parameterization	
		Address	Shift factor, e. g.
Phase current	I_R test socket	–	–

4.7 Manual optimization

Setting with the drive enabled and speed $n = 0$

Parameter P-115 is increased from the pre-set value until the characteristic remains stable. If oscillations develop, reduce the value until the characteristic stabilizes again.

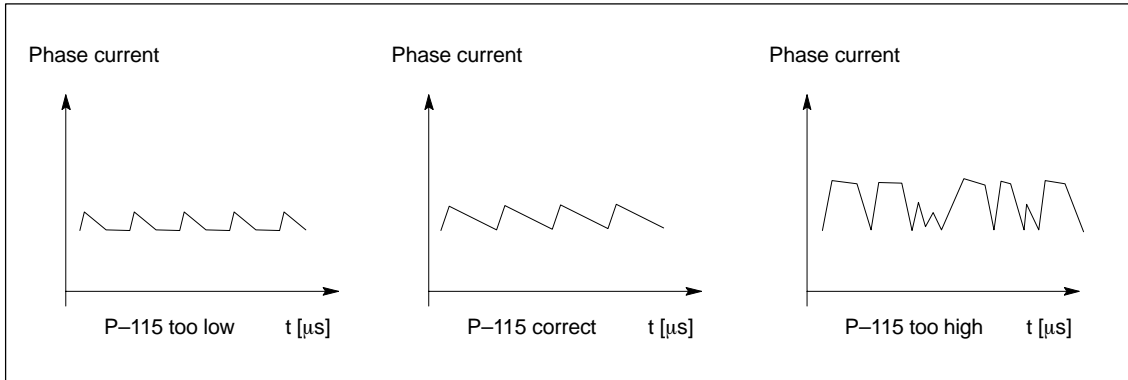

Fig. 4-1 Current controller optimization, base speed range

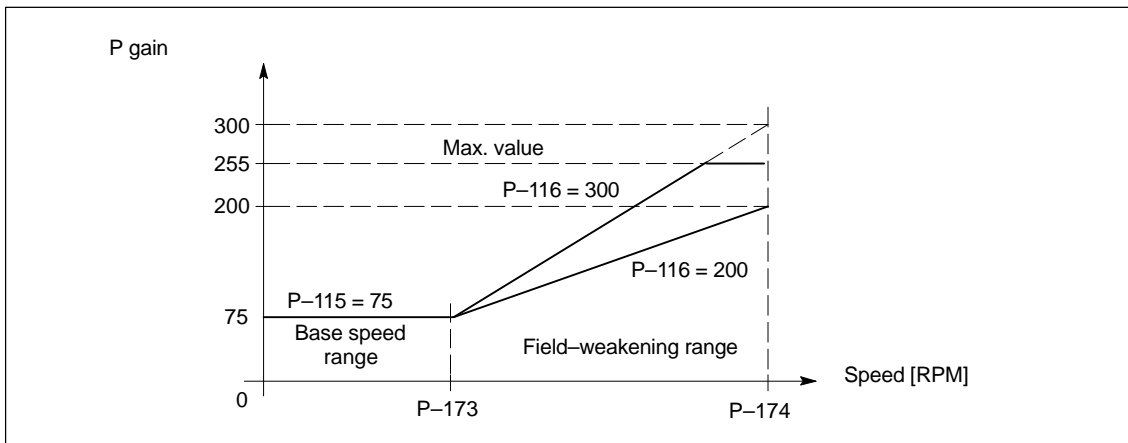

Fig. 4-2 Current controller optimization, field-weakening range

Above the field-weakening speed P-173, the current controller gain is linearly increased and reaches, at the maximum speed P-174, the value of P-116; the maximum value is 255.

If a value > 255 is entered in P-116, then the current controller gain already reaches the maximum value at speeds $< P-174$.

$$P116.M = 255 - (255 - P115.M) \cdot \frac{P173.M}{P174.M}$$

In some cases, the response can be further improved with a somewhat higher value.

Table 4-17 P gain, current controller base speed range

P-115 P gain, current controller base speed range			
Increase value for		Decrease value for	
No.	Fault profile	No.	Fault profile
F-11	Low current controller dynamic response	F-11	Increased current ripple, whistling noises, other related noises

Table 4-18 P gain, current controller field-weakening range

P-116 P gain, current controller field-weakening range			
Increase value for		Decrease value for	
No.	Fault profile	No.	Fault profile
–	Uneven running under no-load conditions in the upper speed range, torque surges	F-11	Spontaneous stalling

Speed controller

P-031, P gain, speed controller

P-032, integral action time, speed controller

Table 4-19 Parameterization, test socket

Signal name	Test point	Parameterization	
		Address	Shift factor, e. g.
Torque-generating current	X1 test socket	P-076 = 10D2H	P-077 = 0H
Speed actual value	X2 test socket	P-072 = 1110H	P-073 = 4H

The enabled drive is adjusted in oscillation operation:

Enter low setpoint steps in the upper speed range using the oscillation generator.

Using P-031 and P-032, set the required settling characteristics of the speed actual value after the actual limiting is exited.

If different controller settings are required for various speeds, then the speed controller adaptation can be activated (refer to Section 4.1).

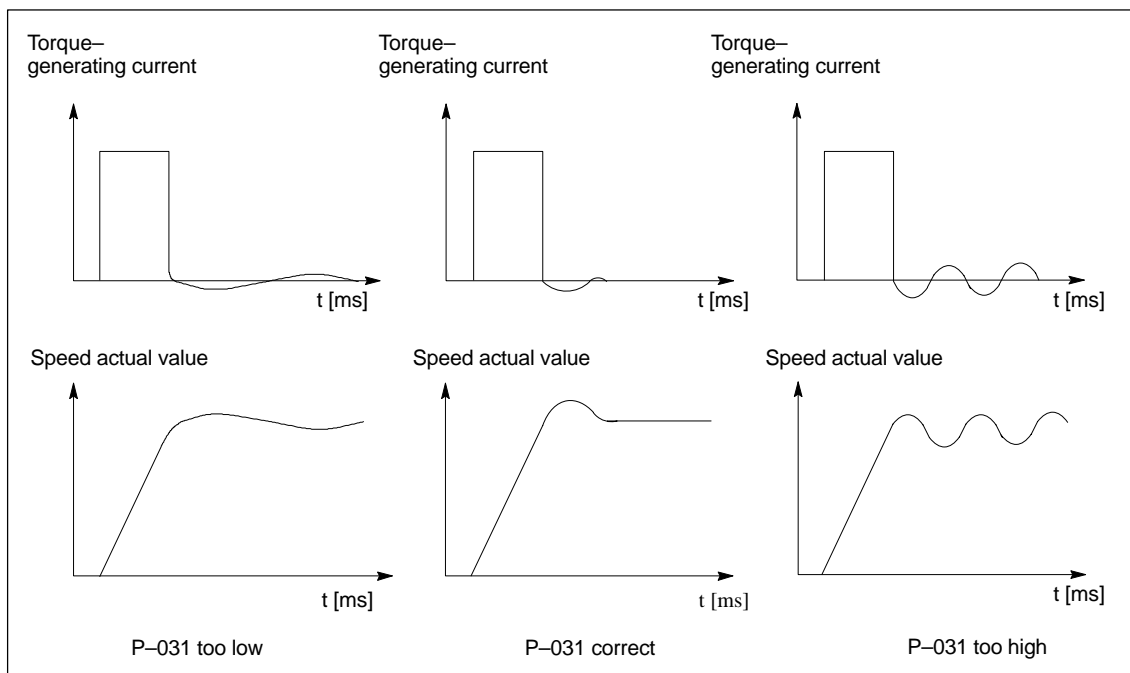

Fig. 4-3 Speed controller optimization

Table 4-20 P gain, speed controller

P-031 P gain, speed controller			
Increase value for		Decrease value for	
No	Fault profile	No	Fault profile
–	Long rise time Overshoot with large period duration for speed steps	–	Speed oscillations with low period duration for speed steps

Table 4-21 Integral action time, speed controller

P-032 integral action time, speed controller			
Increase value for		Decrease value for	
No	Fault profile	No	Fault profile
–	Tendency to oscillate for elastic couplings with large external moments of inertia	–	Slow corrective behavior for speed changes

Field controller

P-034, P gain, field controller

P-035, integral action time, field controller

Table 4-22 Parameterization, test socket

Signal name	Test point	Parameterization	
		Address	Shift factor, e. g.
Speed actual value	X1 test socket	P-076 = 1110H	P-077 = 0H
Field-generating current	X2 test socket	P-072 = 10CAH	P-073 = 2H

Adjustment with the drive enabled in oscillation operation

Using the oscillation generator and ramp-function generator, brake from maximum speed down to below the changeover speed P-172 along a ramp.

Increase parameter P-034 from the calculated value, until the field-generating current remains stable. If oscillations develop, reduce the value, or increase P-035, until the characteristics re-stabilizes.

Check:

- Setpoint steps in the field-weakening range
Increase P-034 if there is a tendency to stall (F-11).
- No-load behavior over the total speed range
For uneven no-load running with torque surges up to stalling (F-11), reduce P-034.

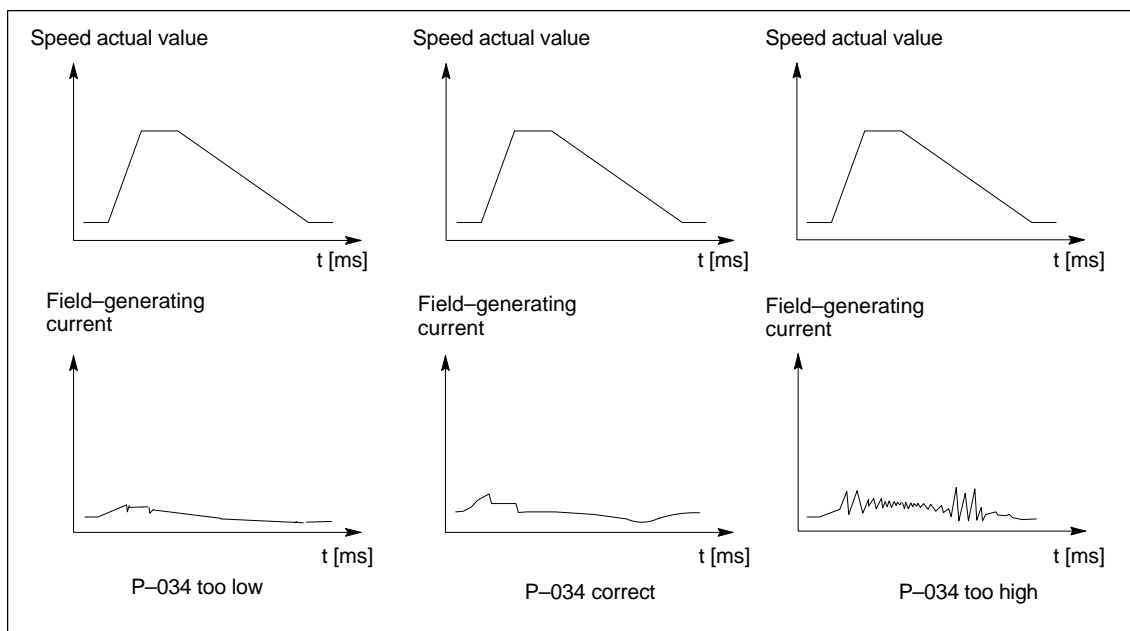

Fig. 4-4 Field controller optimization

Table 4-23 P gain, field controller

P-034 P gain, field controller			
Increase value for		Decrease value for	
No.	Fault profile	No.	Fault profile
F-11	Stalling, especially in the field-weakening range for speed steps	F-11	Tendency to oscillate, field-generating current Speed ripple Torque surges Stalling under no-load conditions

P-166 no-load motor current

Note

If the value of parameter P-166 is changed, the magnetizing reactance P-171 must be re-adjusted.

Table 4-24 Parameterization, test socket

Signal name	Test point	Parameterization	
		Address	Shift factor, e. g.
Phase current	IR test socket	–	–
Motor current	(P-007) display	–	–
Voltage actual value	(P-010) display	–	–

Table 4-25 Settings

Settings with the drive enabled and de-coupled load	
Parameter	Procedure
P-172	Changeover speed, closed-loop/open-loop control Set P-172 > P-164 · 60/p s/min Document the original value
P-057	Current setpoint for the open-loop controlled range Set P-057 = 50 % Document the original value
Speed set-point	Adjust, so that $(P-005) = \frac{V_A}{(P-162/P-164) + 2\pi \sqrt{3} \cdot P-158 \cdot P-161}$ with VA output voltage IM module VA ≤ 400 V for VDC link = 600 V VA ≤ 420 V for VDC link = 625 V VA ≤ 0.8 · Vsupply for VDC link, non-controlled
P-057	Current setpoint for the open-loop controlled range Adjust, so that (P-010) = VA
P-166	No-load motor current Set P-166 = P-161 · P-057/100 %
P-172	Changeover speed, closed-loop/open-loop control Enter the original value
P-057	Current setpoint for the open-loop controlled range Enter the original value

**P-171
magnetizing
reactance**

Note

If the value of parameter P-171 is changed, then the no-load motor current P-166 must also be re-adjusted.

Table 4-26 Parameterization, test socket

Signal name	Test point	Parameterization	
		Address	Shift factor, e. g.
Integral component, field controller	X1 test socket	P-076 = 116A	P-077 = 2

Adjustment with drive enabled for the field-weakening speed P-173.

Adjust the integral component, field controller to zero using parameter P-171.

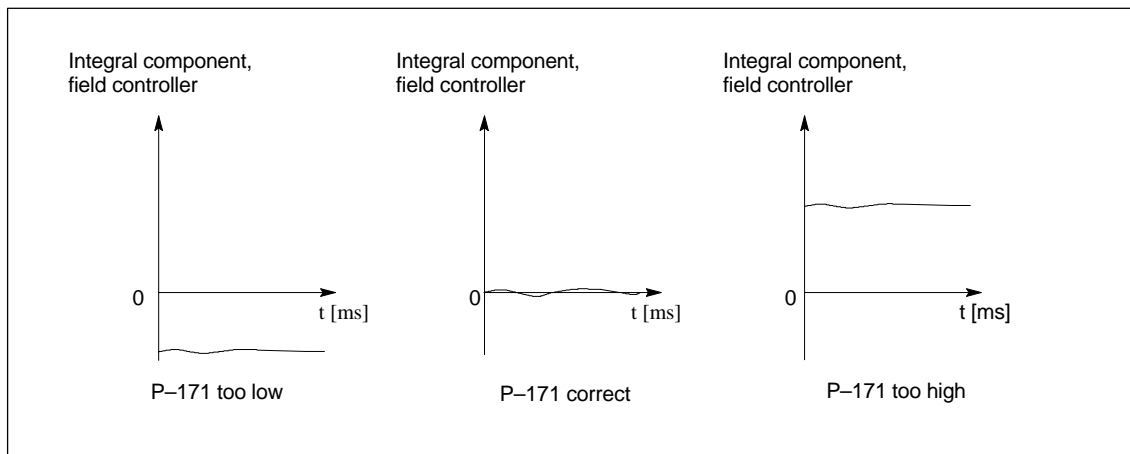

Fig. 4-5 Optimization, magnetizing reactance

P-159
moment of inertia,
motor and external

P-219
additional moment
of inertia

Table 4-27 Parameterization, test socket

Signal name	Test point	Parameterization	
		Address	Shift factor, e. g.
Speed actual value	X1 test socket	P-076 = 1110H	P-077 = 0H
Integral component, speed controller	X2 test socket	P-072 = 117CH	P-073 = 2H

Adjusting with coupled load with the drive enabled in the oscillation mode

Enter setpoint steps of $n = 2 \cdot P-172$ to n_{max} using the oscillation generator.

Adjust the integral component of the speed controller using parameter P-159 or P-219 so that this remains at approximately zero during the acceleration phase.

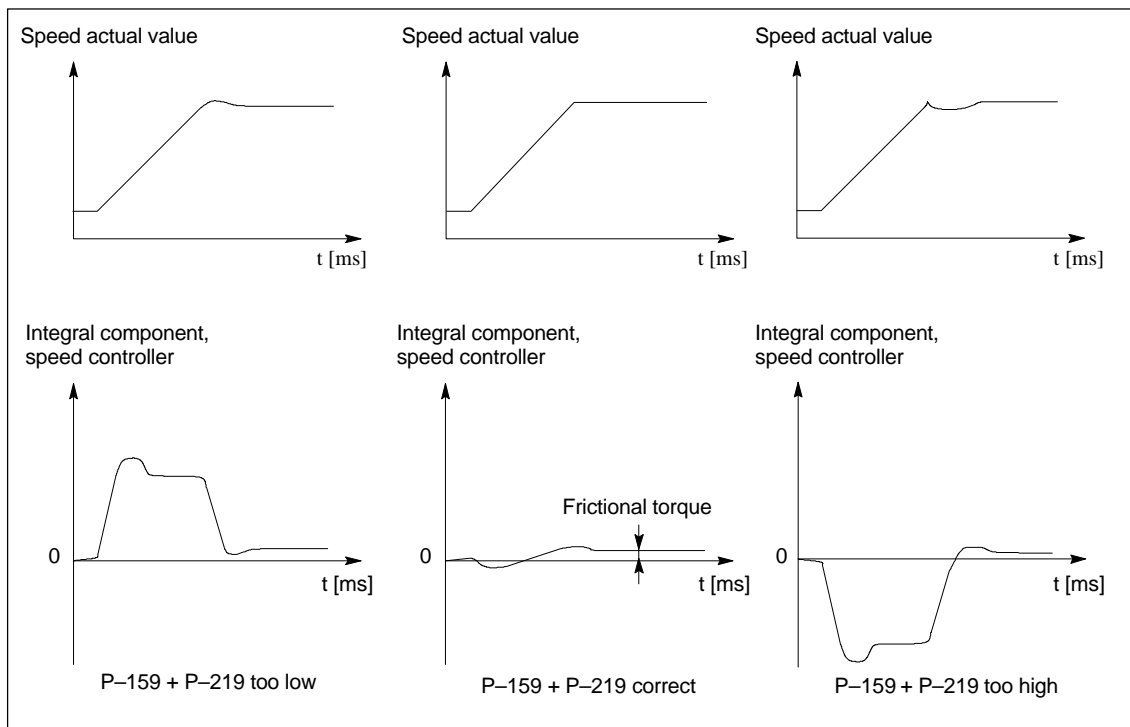

Fig. 4-6 Optimization, moment of inertia

AM

**P-168
motor rotor
resistance**

Note

The motor rotor resistance does not have to be adjusted for motors with deep-bar squirrel-cage rotors.

Table 4-28 Parameterization, test socket

Signal name	Test point	Parameterization	
		Address	Shift factor, e. g.
Speed actual value	X1 test socket	P-076 = 1110H	P-077 = 0H
Integral component, speed controller	X2 test socket	P-072 = 117CH	P-073 = 2H

Adjustment with the drive enabled in the oscillation mode

Enter setpoint steps in the speed range from $n = 2 \cdot P-172$ to $n = n_{max}$ using the oscillation generator.

Adjust the integral component of the speed controller using parameter P-168 so that an overshoot at the end of the acceleration phase is compensated.

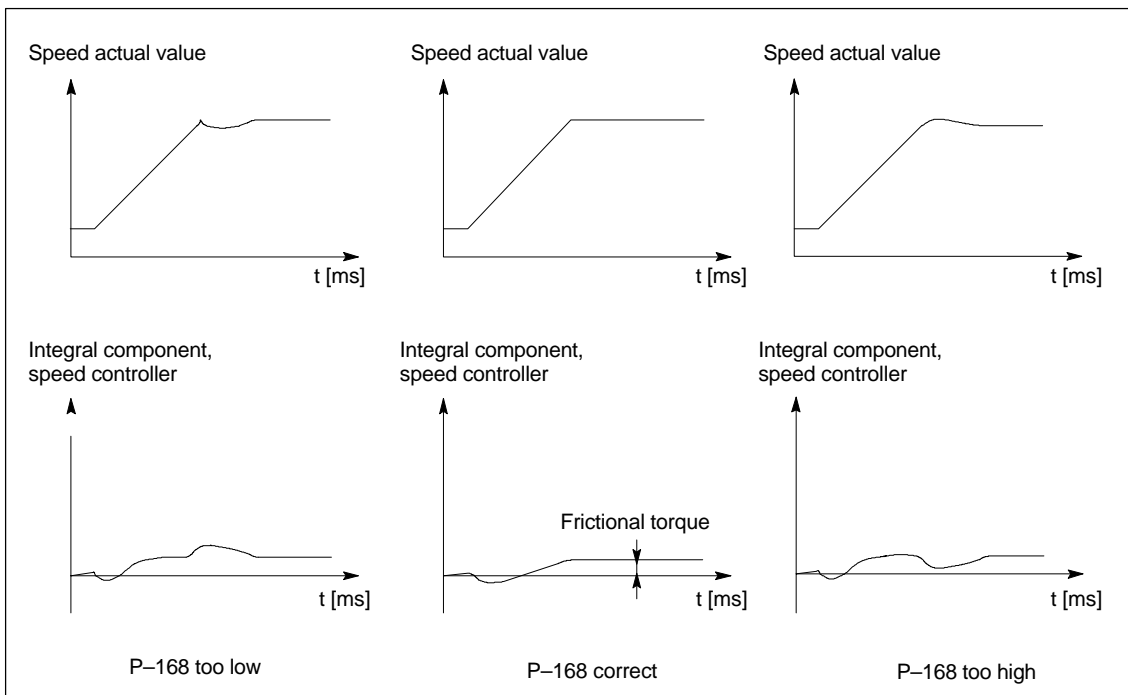

Fig. 4-7 Optimization, motor rotor resistance



5

Diagnostics and Fault Analysis

5.1 Diagnostic resources

5.1.1 Measured value displays

**Warning**

If the motor pulses are canceled, there is no longer any information about the motor speed. The calculated speed actual value is then set to zero. This means that none of the speed actual value displays provide any info. With the exception of P-133, speed actual value BERO, if the speed is monitored.

Table 5-1 Measured value displays

Parameter attributes			Setting range	Description
Number	Change effective	P-051		
(P-001) (P-101)	–	–	–32000...32000 RPM	Speed setpoint
(P-002) (P-102)	–	–	–32000...32000 RPM	Speed actual value
(P-003)	–	–	–399.0...399.0 %	Torque-generating current referred to the rated motor current
(P-004)	–	–	0.0...100.0 %	Utilization refer to the effective limiting
(P-005)	–	–	–1250...1250 Hz	Motor frequency
(P-006)	–	–	0...700 V	DC link voltage realized via NE or monitoring module or via P-061
(P-007)	–	–	–399.0...399.0 %	Motor current referred to the rated motor current
(P-008)	–	–	0.0...399.0 %	Field current components referred to the rated motor current
(P-009)	–	–	0.0...399.0 %	Active power referred to the rated motor output
(P-010)	–	–	0...450 V _{rms}	Voltage actual value
(P-110)	–	–	0...170°C	Motor temperature
(P-133)	–	–	0...65535 RPM	Speed actual value BERO
(P-037)	–	–	2.8 kHz...7.8 kHz	Inverter clock cycle frequency

5.1.2 Status displays

P-000, P-100 operating display Refer to Section 2.2.1







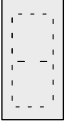

P-011
status of the
digital inputs

Table 5-2 P-011 status of the digital inputs

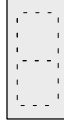
Display							
Display value							
	-	Term. 63 Central pulse enable	Term. E9 Freely-prog. via P-089	Term. E5 Freely-prog. via P-085	Term. E1 Freely-prog. via P-081		
	-	Term. 64 Central drive enable	Term. 663 Axis-specific pulse enable	Term. E6 Freely-prog. via P-086	Term. E2 Freely-prog. via P-082		
	-	Term. 112 open Setting-up operation	Term. 65 Axis-specific controller enable	Term. E7 Freely-prog. via P-087	Term. E3 Freely-prog. via P-083		
	-	Term. R Central fault acknowledgement	Term. 81 open Fast ramp-function generator stop	Term. E8 Freely-prog. via P-088	Term. E4 Freely-prog. via P-084		
Several messages can be displayed. The hexadecimal addition is displayed. Example: 4H + 8H = CH							

P-254
display, active
functions 1

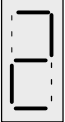
Table 5-3 P-254 display, active functions 1

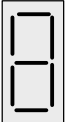
Display						
Display value						
	–	Fct. No. 13 Ramp-function generator 2	Fct. No. 9 Gearbox stage bit 0	–	Fct. No. 1 2nd torque limit	
	–	Fct. No. 14 Increase setpoint	Fct. No. 10 Gearbox stage bit 1	–	Fct. No. 2 Oscillation	
	–	Fct. No. 15 Decrease setpoint	Fct. No. 11 Gearbox stage bit 2	Fct. No. 7 Ramp-up time $T_H = 0$	Fct. No. 3 Reset fault memory (fault acknowledgement)	
	–	Fct. No. 16 Setpoint enable	Fct. No. 12 Clockwise/ counter- clockwise rotating field	–	–	
Several messages can be displayed. The hexadecimal addition is displayed. Example: 4H + 8H = CH						

5.1 Diagnostic resources

**P-255
display, active
functions 2**

Table 5-4 P-255 display, active functions 2

Display							
Display value							
	-	-	-	Fct. No. 21 Motor selection bit 1	Fct. No. 17 Fixed setpoint bit 0		
	-	-	-	Fct. No. 24 Fixed setpoint bit 3	Fct. No. 18 Fixed setpoint bit 1		
	-	-	-	-	Fct. No. 19 Fixed setpoint bit 2		
	-	-	-	-	Fct. No. 20 Motor selection bit 0		
Several messages can be displayed. The hexadecimal addition is displayed. Example: 4H + 8H = CH							

5.1.3 Diagnostic parameters

P-020 auto-setting routine

Table 5-5 P-020 auto-setting routine

Display										
Display value										
	-	-	-	-	Automatic optimization 5 Adjustment, moment of inertia	Automatic optimization 1 Optimization, phase current controller				
	-	-	-	-	Automatic optimization 6 Adjustment, rotor resistance	Automatic optimization 2 Adjustment, power offset				
	-	-	-	-	Automatic optimization 7 Calculation, speed controller	Automatic optimization 3 Adjustment, no-load current				
	-	-	-	-	Automatic optimization 8 Adjustment, field weakening speed	Automatic optimization 4 Adjustment, magnetizing reactance				
Several messages can be displayed. The hexadecimal addition is displayed. Example: 4H + 8H = CH										

5.1 Diagnostic resources

Table 5-6 Diagnostics and checksum parameter

Parameter attributes			Setting range	Description		
Number	Change effective	P-051				
(P-028)	-	-	0...FFFFH	Diagnostics		
				Bit	Value	
				13	2000H	Division interrupt Error in the calculation routine due to incorrectly entered data
(P-200)	-	-	0...FFFFH	Checksum parameter For each data save operation (P-052=1H), the checksum is generated over the parameter contents. This means that a change in the drive-machine data is recognized.		

5.1.4 Test sockets X1, X2, IR

Overview

- Function
- Technical data
- Assignment
- Normalization IR
- Parameterization X1 (DAU 3), X2 (DAU 4)

Function

Analog output of the phase current actual value and RAM variables for measuring and diagnostics.

Technical data

- Phase current actual value at test socket IR
- 2 output channels at X1 (DAU 3) and X2 (DAU 4)
- Voltage range 0...+ 5 V (value 0 corresponds to +2.5 V)
- Coarse normalization, offset compensation for X1 and X2 via parameter

Assignment

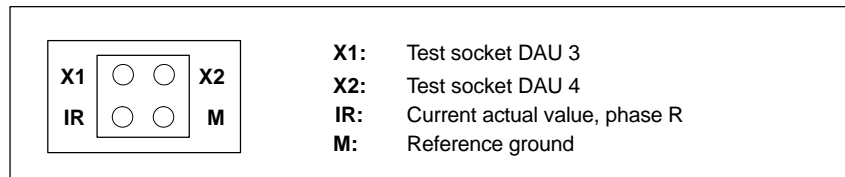

Fig. 5-1 Assignment, test sockets

Normalization IR

Table 5-7 Normalization IR

Power module code number (P-095)	Normalization IR
1	8 A corresponds to 8.25 V
2	15 A corresponds to 8.25 V
4	25 A corresponds to 8.25 V
6	50 A corresponds to 8.25 V
7	80 A corresponds to 8.25 V
8	160 A corresponds to 8.25 V
9	160 A corresponds to 8.25 V
10	200 A corresponds to 8.25 V
11	300 A corresponds to 8.25 V
12	400 A corresponds to 8.25 V
13	120 A corresponds to 8.25 V

5.1 Diagnostic resources

**Parameterization
X1 (DAU 3),
X2 (DAU 4)**

Table 5-8 Parameterization X1 (DAU 3), X2 (DAU 4)

Parameter attributes			Setting range	Description
Number	Change effective	P-051		
P-076	Online	4	0...FFFF hex	Address, DAU 3 Address of the RAM variables which are to be output at DAU 1. Default: 1110H calculated speed actual value, 1 V corresponds to 15000 RPM
P-077	Online	4	0...F hex	Shift factor, DAU 3 Coarse normalization of the selected data value by shifting the binary number to the left. Shift to the left by 1 = multiplication by 2 max. gain: 32768
P-080	Online	4	-127...127 dec	Offset, DAU 3 Compensation of a possibly existing offset for DAU 3
P-072	Online	4	0...FFFF hex	Address, DAU 4 Default: 10D2H Torque-generating current 1 V corresponds to $1.6 \cdot I_{rated\ motor}$
P-073	Online	4	0...F hex	Shift factor, DAU 4
P-074	Online	4	-127...127 dec	Offset, DAU 4

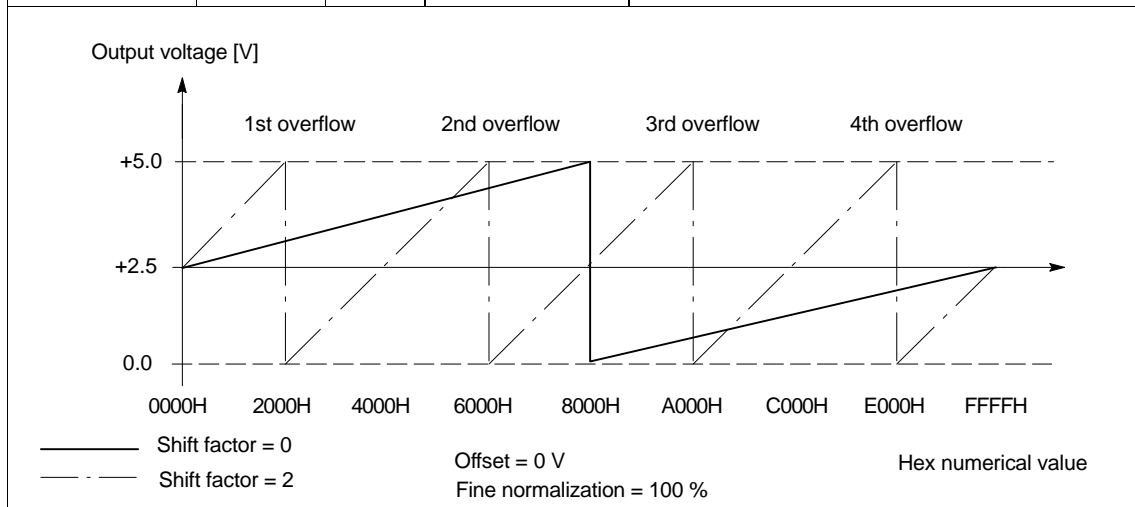

Note

A list of the most important measured quantities (RAM variables) and their addresses are listed in the Attachment (Section 6.5).

5.1.5 Minimum/maximum value memory

Function Monitoring RAM variables for minimum and maximum values.

Table 5-9 Minimum/maximum value memory

Parameter attributes			Setting range	Description
Number	Change effective	P-051		
P-181	Online	4	0...FFFF hex	Address for min/max memory (address of the monitored RAM variable) The value can be saved in the drive-machine data memory.
P-179	Online	4	0...3 hex	Select min/max memory 0H: Stop memory function 1H: Start memory function with absolute value evaluation 2H: Start memory function with bipolar evaluation 3H: Stop memory function
(P-182)	–	–	0...FFFF hex	Minimum value, min/max memory
(P-183)	–	–	0...FFFF hex	Maximum value, min/max memory

Note

A list of the most important measured quantities (RAM variables) and their addresses are listed in the Attachment (Section 6.5).

5.1 Diagnostic resources

5.1.6 Transient recorder function

Function Two RAM variables are simultaneously recorded and output via test sockets X1 and X2.

Technical data

- Two 16-bit signals are recorded in parallel
- 640 words of recording depth
- 1 ms sampling time (P-090, bit3=0) or 0.6ms (P-090, bit3=1, from FW 3.00)
- Start and stop conditions (trigger conditions)
- Cyclic output via DAUs
- Trigger edge for output

Parameterization

Table 5-10 Parameterization

Parameter attributes			Setting range	Description
Number	Change effective	P-051		
P-207	Online	4	0...C hex	Transient recorder setting Records two RAM variables over 640 ms with 1 ms sampling. 1H: Start via P-206 without start and stop condition Start via P-206 = + 1. Stop 640 ms after input 2H: Start condition via P-208 and P-209, no stop condition. Start via P-206 = +1. Stop 640 ms after start condition. 5H: Stop condition via P-210 and P-211, no start condition. Start via P-205 = +1. Records for the last 640 ms before the stop condition 6H: Recording with start and stop condition, max. 640 ms 4H: Default of the recording memory via P-217 The parameter is reset to 0 after successful recording.
P-212	Online	4	0...FFFF hex	Address, signal 1 A list of the most important measured quantities (RAM variables) and their addresses are listed in the Attachment (Section 6.5).
P-213	Online	4	0...FFFF hex	Address, signal 2

Table 5-10 Parameterization

Parameter attributes			Setting range	Description
Number	Change effective	P-051		
P-208	Online	4	0...FFFF hex	Address for start condition Addresses of the RAM variables which start the recording operation.
P-209	Online	4	0...FFFF hex	Threshold for start condition Start condition mask is compared with the RAM variable in P-208.
P-210	Online	4	0...FFFF hex	Address of the stop condition
P-211	Online	4	0...FFFF hex	Threshold of the stop condition
P-206	Online	4	0...1 hex	Select transient recorder Start the transient recorder function by setting P-206 to +1. The parameter is reset to 0 after successful recording.
P-215	Online	4	0...15 dec	Shift factor, signal 1 Refer to the description, test sockets X1, X2
P-216	Online	4	0...15 dec	Shift factor, signal 2
P-217	Online	4	0...FFFF hex	Trigger signal 1 Trigger signal amplitude "low" for DAU (D/A converter) output with 1 ms duration. When entering various signal levels in P-217 and P-218, an edge is output, which is then followed by the traced signal.
P-218	Online	4	0...FFFF hex	Trigger signal 2 Trigger signal amplitude "high" for DAU (D/A converter) output with 1 ms duration.
P-214	Online	4	0...1 hex	Start trace output The traced values are cyclically output at the DAU. The output is repeated until the parameter is reset to 0. Trace signal 1 → DAU 3 (X1) Trace signal 2 → DAU 4 (X2) The previous DAU assignment is buffered and is re-set after the output function has been completed.

Note

A list of the most important measured quantities (RAM variables) and their addresses are listed in the Attachment (Section 6.5).

5.1.7 Current/Hz control



Warning

If a drive is operated for a longer period of time in the open-loop controlled speed range, the motor must be adequately cooled, as a current approximately equal to the rated current is impressed (percentage in P-057).

Caution for self-ventilated motors.

Function

Diagnostics for incorrect parameterization in the closed-loop controlled range.

The motor can be operated open-loop current/Hz controlled for test purposes. In this case, the speed and field control (closed-loop) are ineffective.

Function information

The changeover speed between closed-loop control and open-loop control P-172 should be set high enough, so that it is not exceeded in test operation.

Above the field weakening speed (P-173), the absolute current should be set less than the no-load current, as otherwise the voltage limiting would intervene. This would result in uneven motor running and torque surges.

Table 5-11 Current/Hz control

Parameter attributes			Setting range	Description
Number	Change effective	P-051		
P-057.M	Online	4	0...150 %	Current setpoint in the open-loop controlled range Percentage of the rated motor current Current setpoint for current/Hz control
P-058.M	Online	4	0...399 %	Accelerating torque in the controlled range (open-loop) Percentage of the rated motor torque
P-172.M	Online	4	0...32000 RPM	Changeover speed, closed-loop/open-loop control This changeover is made with a hysteresis of 200 RPM.

5.2 Fault analysis

5.2.1 Fault display, fault acknowledgement

Fault display

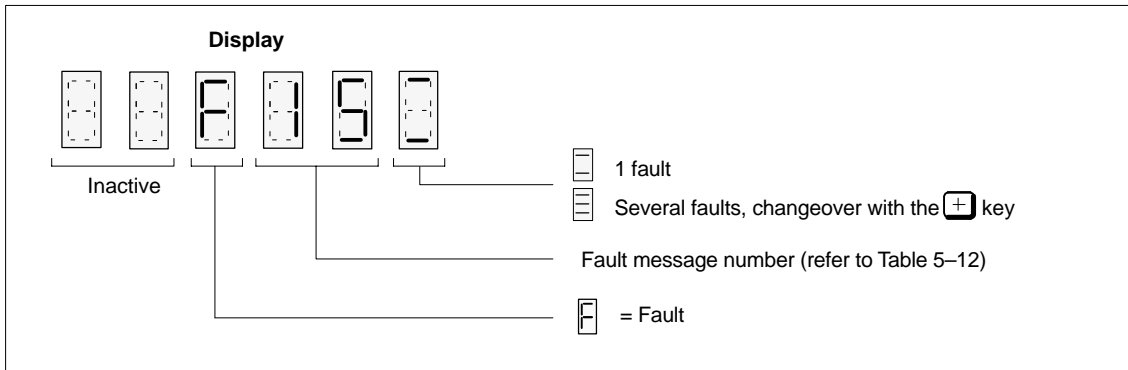

Fault acknowledgement

Using the **P** key

Press the **P** key with the controller inhibit present.

If the fault can be acknowledged, then the system returns to the operator program.

If the fault cannot be acknowledged, e.g. there is a defect, the fault display can be temporarily suppressed.

- **Remote acknowledgement**

One of the following terminals is energized with the controller inhibited:

- Terminal “R” reset at the NE and monitoring module
- Terminal “Reset fault memory” (freely-programmable terminal function) at the IM module
- Interrupt terminal “65” controller enable (only if P-053, bit 5 =1)

- **Powering-down**

Power-down the unit and approx. 2 s after the display has gone dark, power-up again.

Fault suppression

Using the **-** key

The operator program is selected for approx. one minute after pressing the **-** key – however the fault is not acknowledged.

5.2.2 Fault message list

**Warning**

When the motor pulses are canceled, there is no information about the motor speed. The calculated speed actual value is then set to 0. The motor pulses can be deleted as a result of fault messages.

Table 5-12 Fault message list

Fault message	Fault	Cause
F-04	Fault for D/A conversion	<ul style="list-style-type: none"> If this message is continually repeated, the control board is defective
F-05	Motor current = 0	<ul style="list-style-type: none"> All of the enable signals are present, but a motor is not connected A motor contactor has not pulled-in. All of the enable signals are present, but at least one of the parameters P-160, P-166, P-057, P-059 is equal to zero. Defective DC link fuse Interrupted DC link busbars
F-07	Data save on the FEPROM unsuccessful	<ul style="list-style-type: none"> If the fault message repeatedly occurs during a data save operation, then the FEPROM is defective. If the fault message occurred immediately after powering-up the drive converter, the drive converter was powered-down during a data save operation. This means that the last parameter changes have not been saved. A new data save must be initiated.
F-08	Irrevocable data loss	<ul style="list-style-type: none"> Defective FEPROM → replace the control board
F-11	Frequency setpoint > maximum frequency	<ul style="list-style-type: none"> Ribbon cable, control board – gating board is defective or is not connected Motor is not connected or a phase is missing Defective power supply of the gating board Defective DC link fusing DC link busbars interrupted Motor stalled, as the motor or controller parameters are completely incorrect The IM module is connected to a monitoring module without DC link voltage sensing, and a value was not entered in P-061 for the DC link voltage For the gearbox stage changeover, the speed limiting P-029 was reduced, although the motor is rotating above this limit. Defective motor
F-13	Field controller is at its limit	<ul style="list-style-type: none"> Motor data or controller data completely incorrect Entered motor data and circuit configuration type Y/Δ of the motor do not match Motor stalled, as the motor or controller data are completely incorrect

Table 5-12 Fault message list

Fault message	Fault	Cause
F-14	Motor overtemperature	<ul style="list-style-type: none"> Motor overloaded Motor current too high, e.g. due to incorrect motor data Defective temperature sensor (motor) Defective motor fan Winding short circuit, motor
F-15	Drive converter overtemperature	<ul style="list-style-type: none"> Drive converter overloaded (incorrect motor/converter assignment, incorrect load duty cycle, clock cycle frequency too high) Ambient temperature too high Fan in the IM module failed Defective temperature sensor in the IM module After cooling below $50^{\circ}\text{C} \pm 15\text{K}$, acknowledgement is only possible by powering-down and powering-up again
F-16	Illegal power module code number	<ul style="list-style-type: none"> Incorrect code number 3 in P-095 selected (for power modules without automatic recognition) Incorrect code number selected in P-095 (for power modules with automatic recognition). From FW 3.00
F-17	$I_{0\text{ motor}} > I_{\text{rated power module}}$	<ul style="list-style-type: none"> Incorrect motor/converter assignment
F-19	Temperature sensor motor <ul style="list-style-type: none"> Interrupted Short-circuit only KTY 84 	<ul style="list-style-type: none"> Defective temperature sensor Connection to the sensor interrupted or short-circuited
F-51	Parameterizing error: Rated torque too high	<ul style="list-style-type: none"> Rated torque (calculated) from P160.M and P163.M greater than 650 Nm From FW 2.00
F-52	Parameterizing error: Illegal torque constant	<ul style="list-style-type: none"> Illegal ratio of $\frac{P-160.M \cdot P-164.M}{P-161.M \cdot P-163.M \cdot P-171.M}$ From FW 2.00
F-53	Parameterizing error: Rated motor current too low	Ratio between the rated motor current and rated power module current too low
F-60	Error for the automatic setting routine	<ul style="list-style-type: none"> Automatic setting routine was interrupted Automatic setting routine did not provide any useful values Speed limiting (P-029, P-174) effective $n_{\text{max}} < (f_{\text{rated}} \cdot 60\text{ s/min})/p$ Configuration Y/Δ and rated data interchanged Other causes, refer to Section 4
F-90	Max. speed BERO exceeded	<ul style="list-style-type: none"> Pulse number P131.M incorrectly parameterized Interrupted cable

Faults

After

- **Power ON**

Operator display inactive

- minimum of two phases missing (NE/monitoring module)
- minimum of two input fuses have failed (NE/monitoring module)
- defective electronics power supply in the NE/monitoring module
- equipment bus connection (ribbon cable) IM module ↔ NE/monitoring module not inserted or defective
- defective IM module
- defective EPROM/FEPRM
- firmware not loaded

- **Controller enable**

Motor rotates counter clockwise, although the IM module outputs a clockwise rotating field or vice versa

- motor rotating field incorrect as the feeder cables are interchanged (interchange 2 phases)



Attachments

6

AM

6.1 Flowchart when commissioning systems



Warning

If a fault at the **NE module** is acknowledged with the IM module enabled, then the drive accelerates to n_{set} .

Note

If the data save operation is interrupted due to power failure or power-down, the values which have been changed are lost, and the drive converter outputs fault message "F-07" when it is powered-up again (refer to Section 5.2.2). The parameter values can be re-selected after fault message "F-07" is acknowledged.

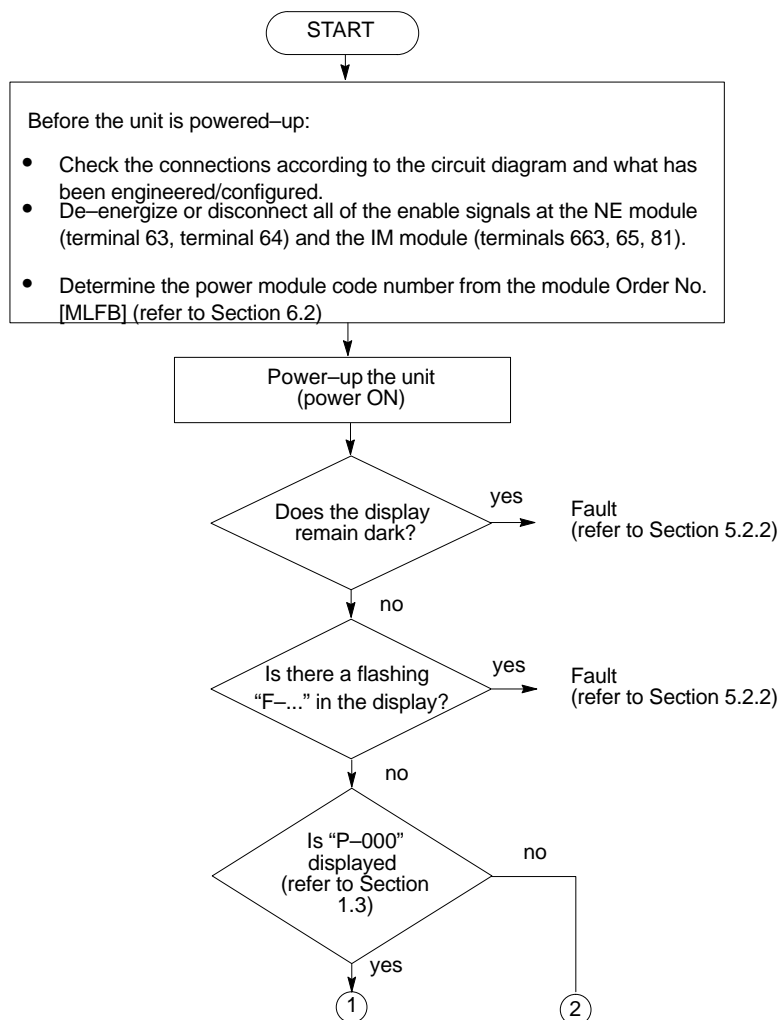

6.1 Flowchart when commissioning systems

The module was already commissioned. In order to adapt it to a new motor, it must first be reset into the initial status.

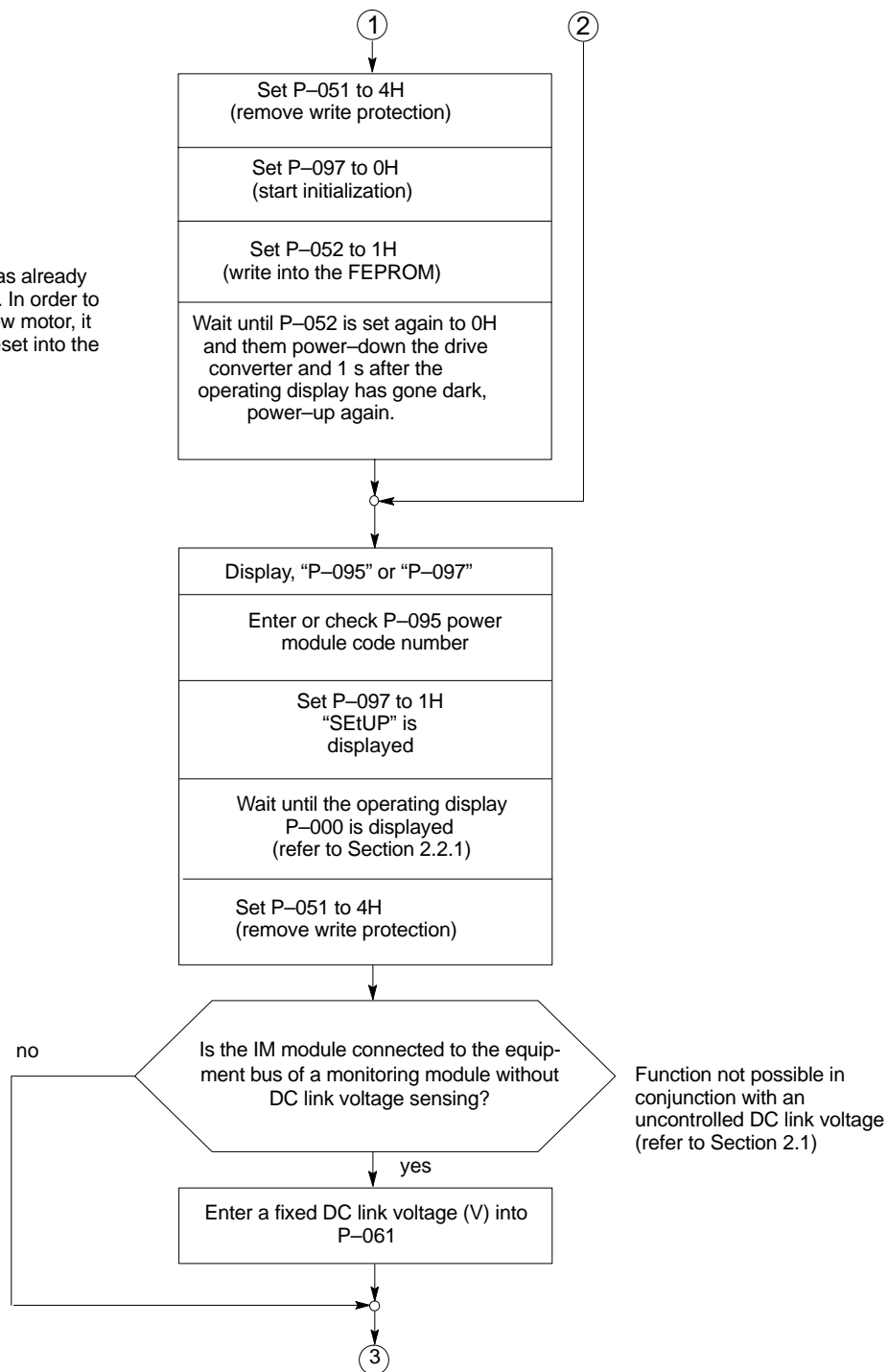

AM

6.1 Flowchart when commissioning systems

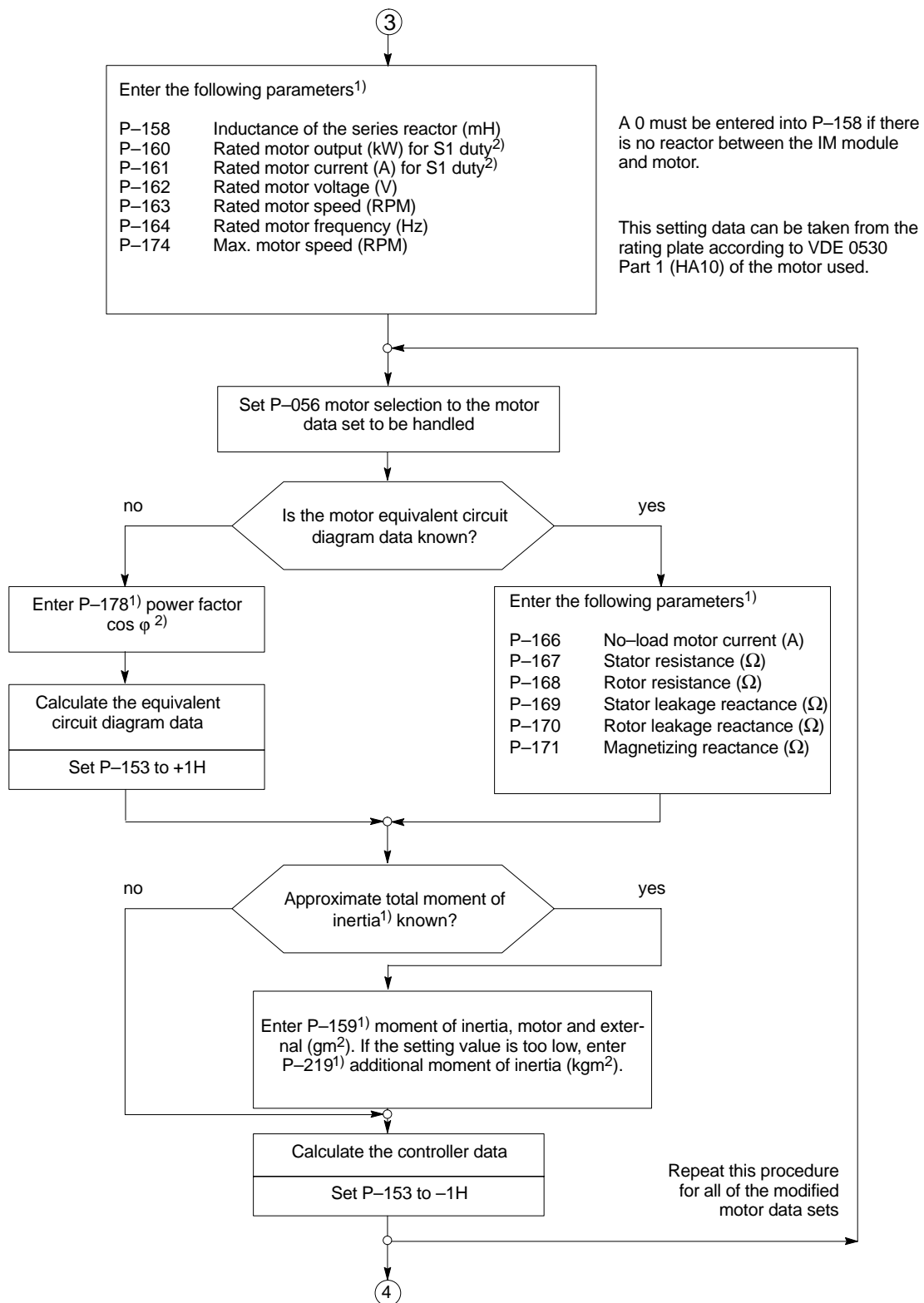

1) Setting data for up to four different motors can be entered (sub-parameters 1 to 4)
 2) For force-cooled motors, refer to the instructions in Section 2.1

6.1 Flowchart when commissioning systems

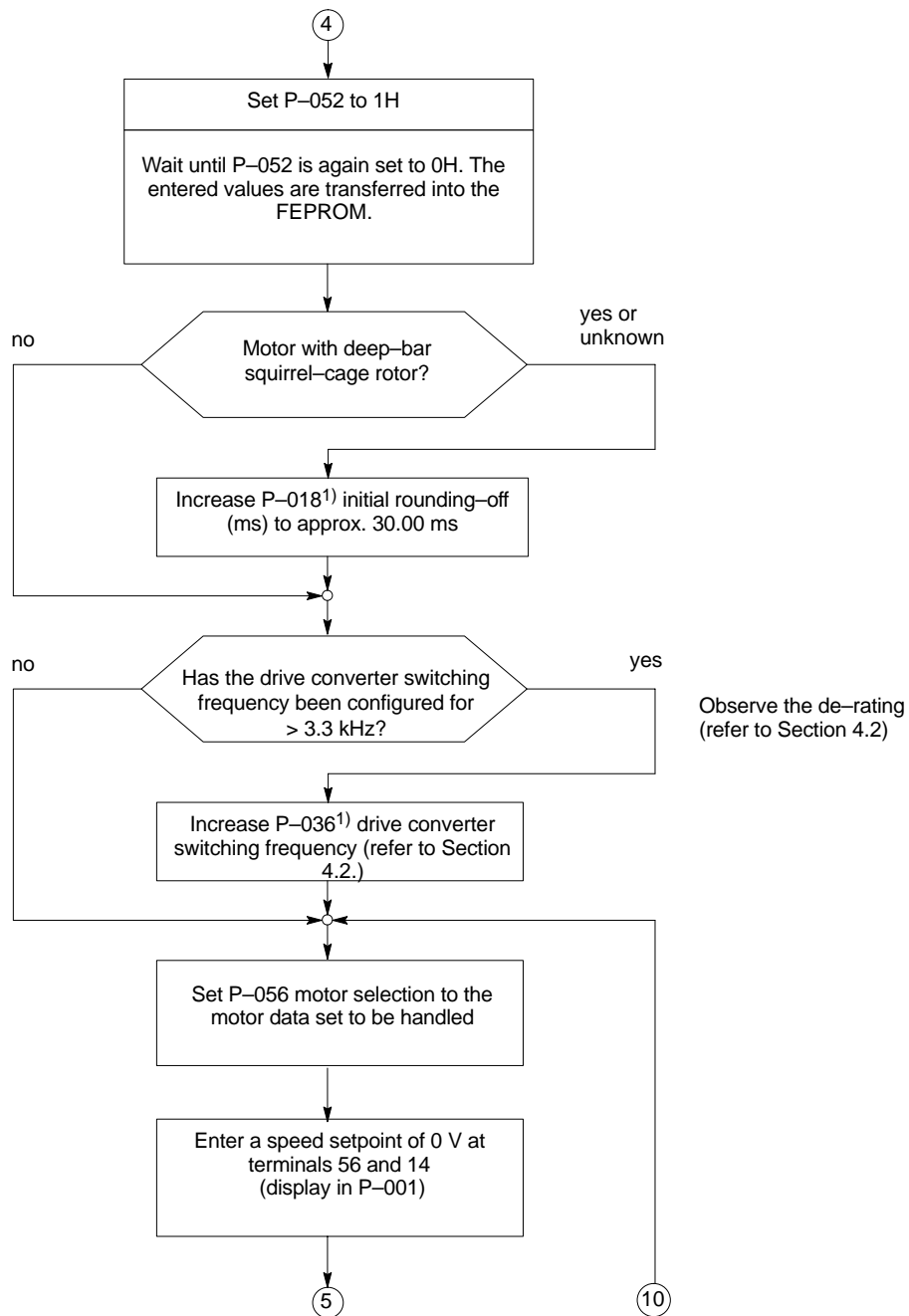

AM

1) Setting data for up to four different motors can be entered (sub-parameters 1 to 4)

6.1 Flowchart when commissioning systems

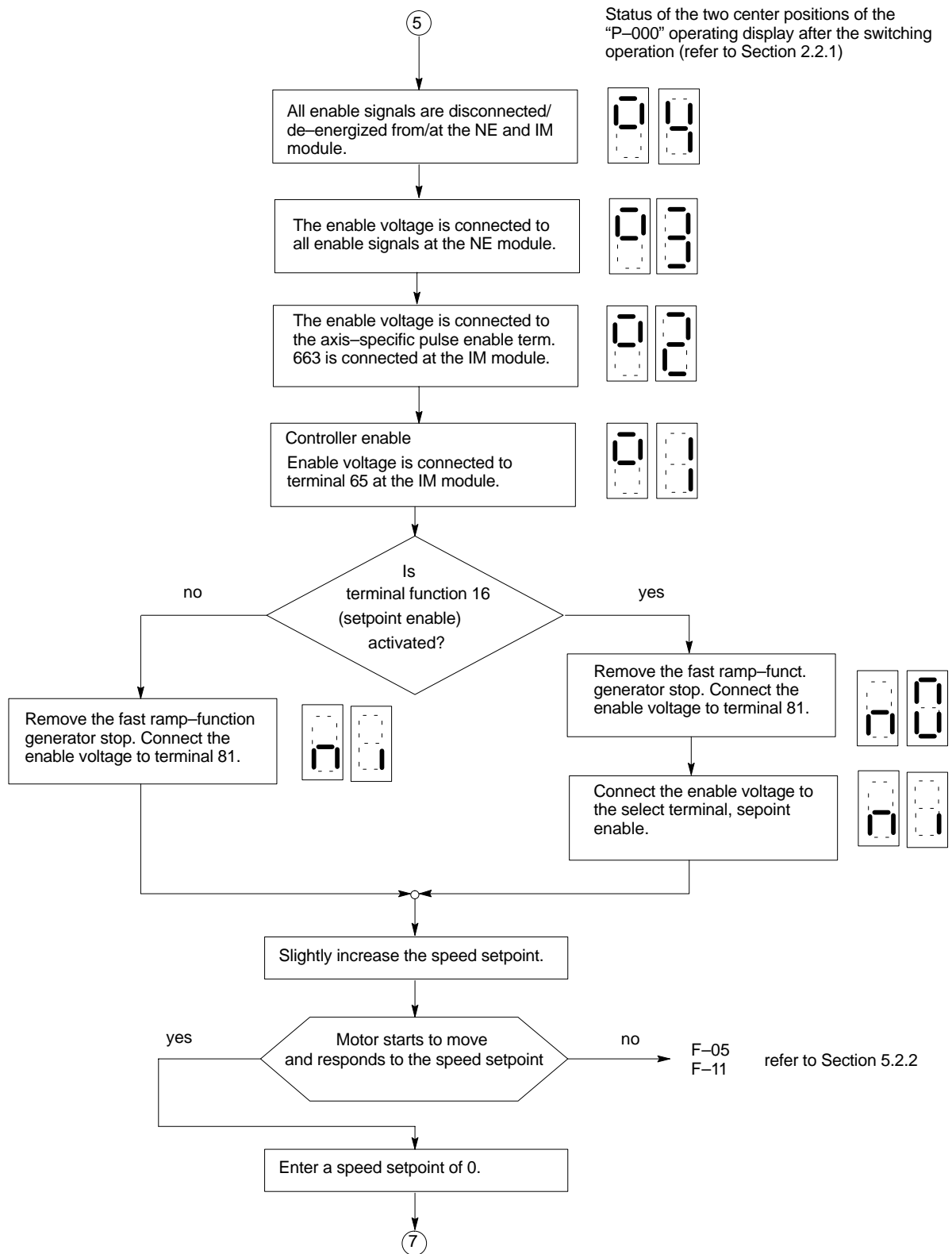

6.1 Flowchart when commissioning systems

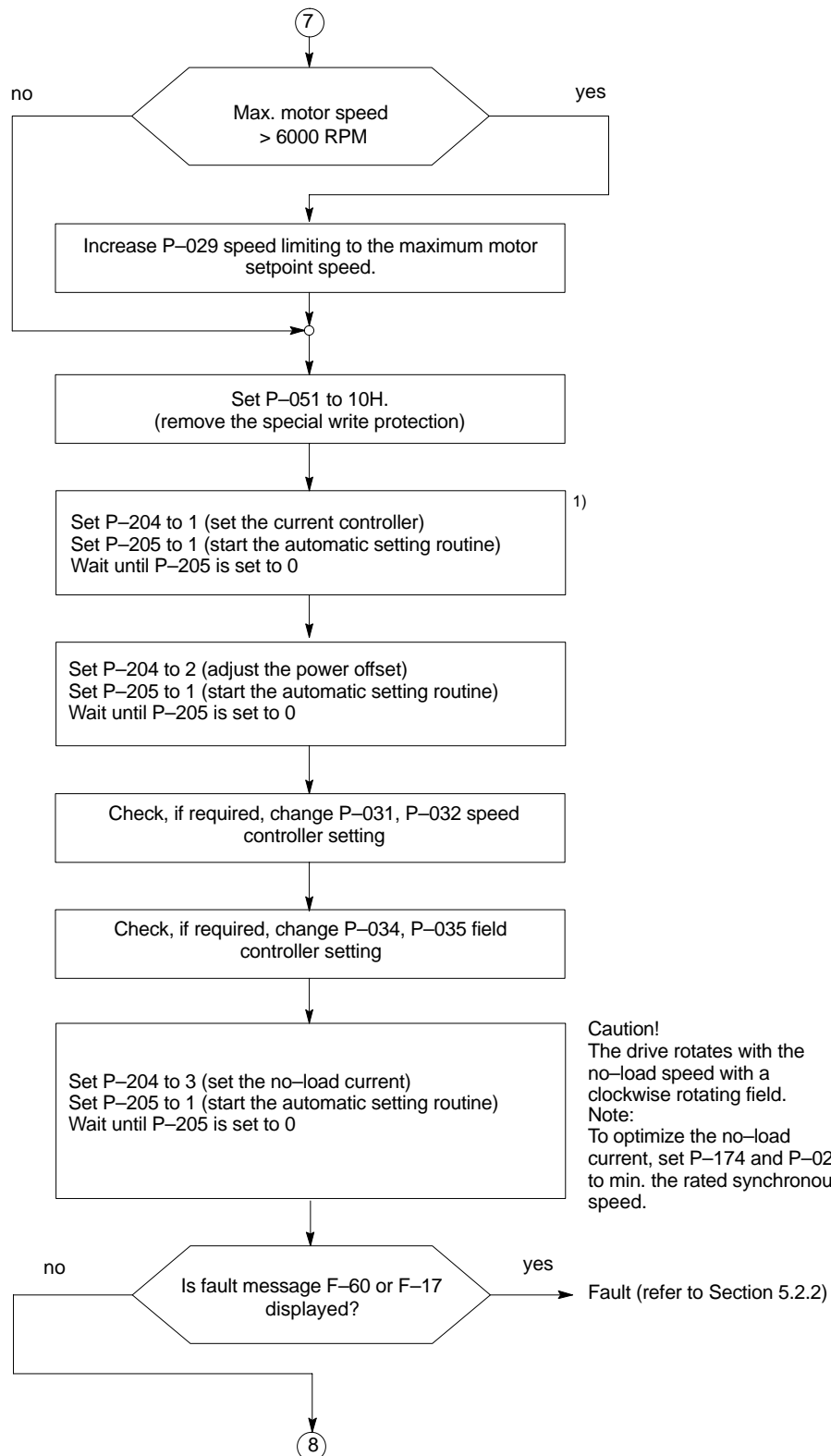

1) No longer necessary from FW 3.00 onwards

6.1 Flowchart when commissioning systems

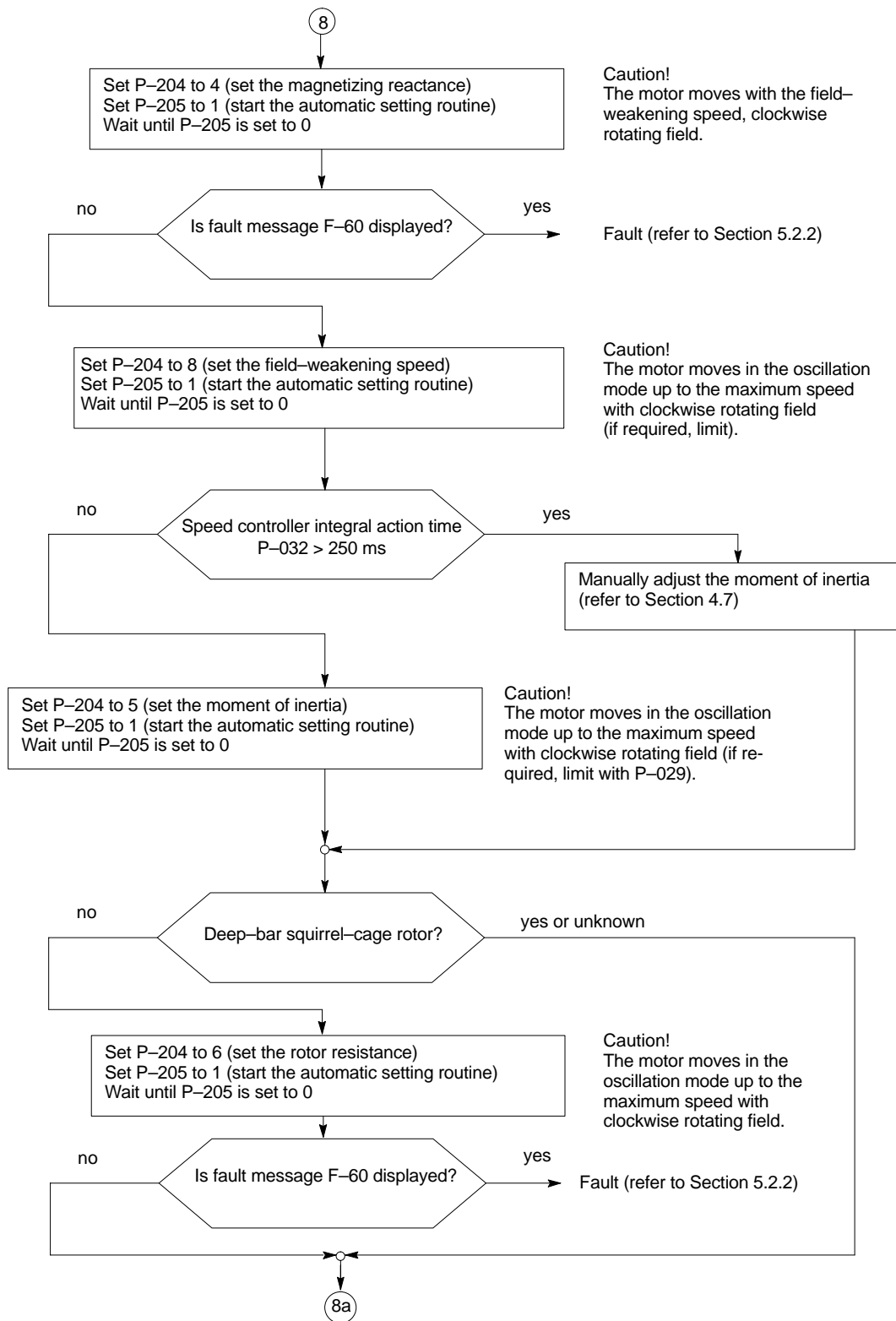

6.1 Flowchart when commissioning systems

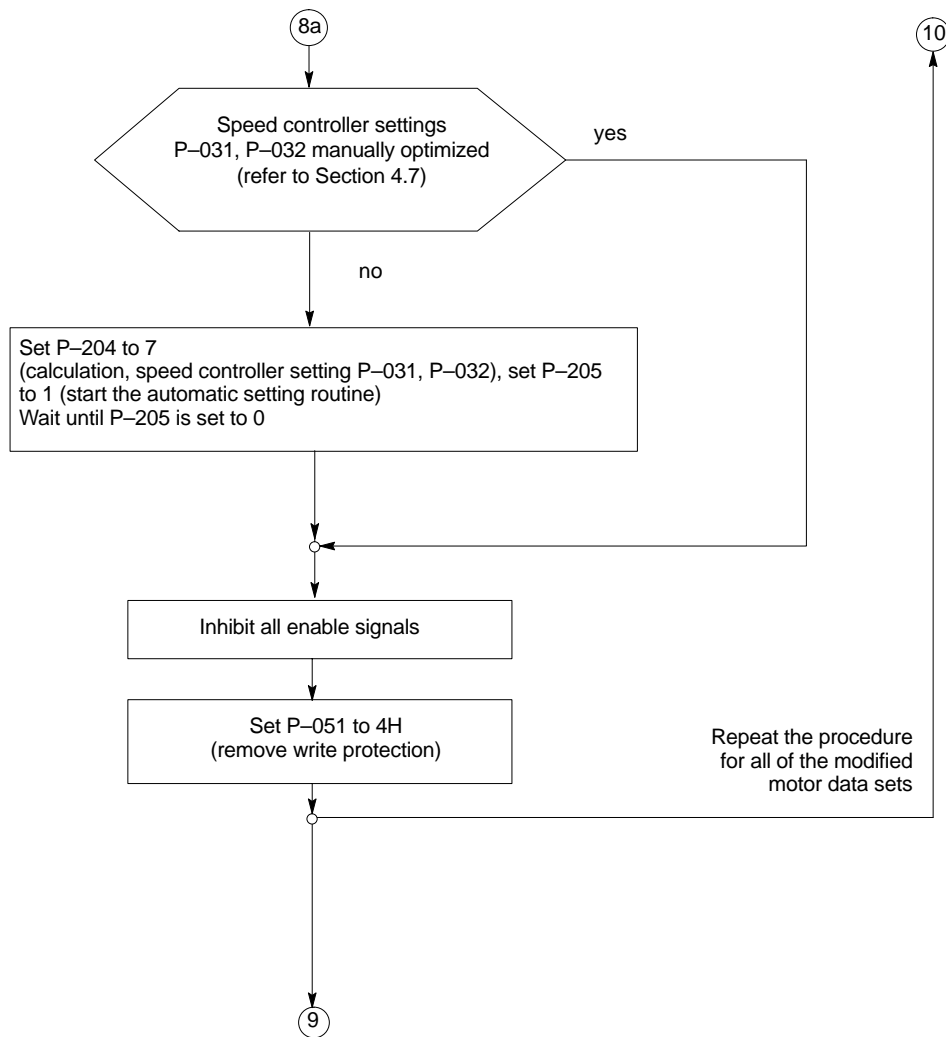

6.1 Flowchart when commissioning systems

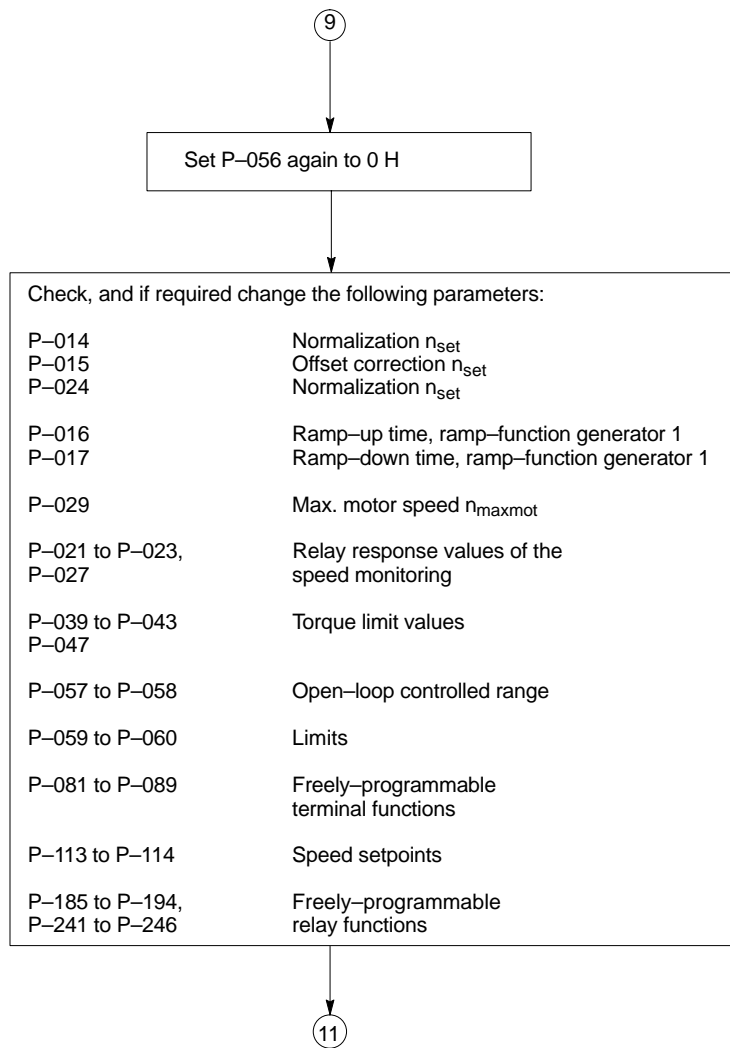

6.1 Flowchart when commissioning systems

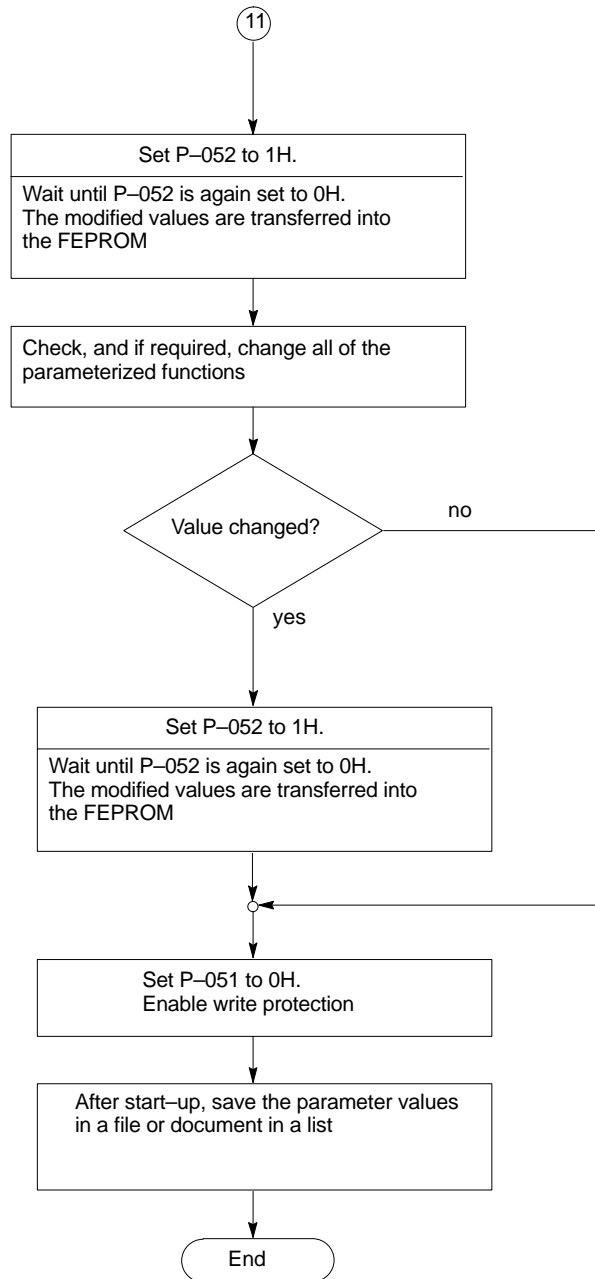

AM

6.2 Power module code numbers

Table 6-1 Power module code numbers

Power module type	Order No. 6SN1123-1AA0□- 6SN1124-1AA0□- 6SN1140-1BA1□-	Rated output current [A]	Peak output current, briefly S6-40% 10min [A]	Peak output current, briefly S6-40% 10s [A]	Power module code number P-095
8 A	-0HA□	3	3	3	1 FW 2.10
15 A	-0AA□	5	5	8	2 FW 2.10
25 A	-0BA□	8	10	16	4
50 A	-0CA□	24	32	32	6
80 A	-0DA□	30	40	51	7
108 A	-0LA□	45	60	76	13 FW 2.10
120 A	-0GA□	45	60	76	8
160 A	-0EA□	60	80	102	9
200 A	-0FA□	85	110	127	10
300 A	-0JA□	120	150	193	11 FW 2.00
400 A	-0KA□	200	250	257	12 FW 2.00

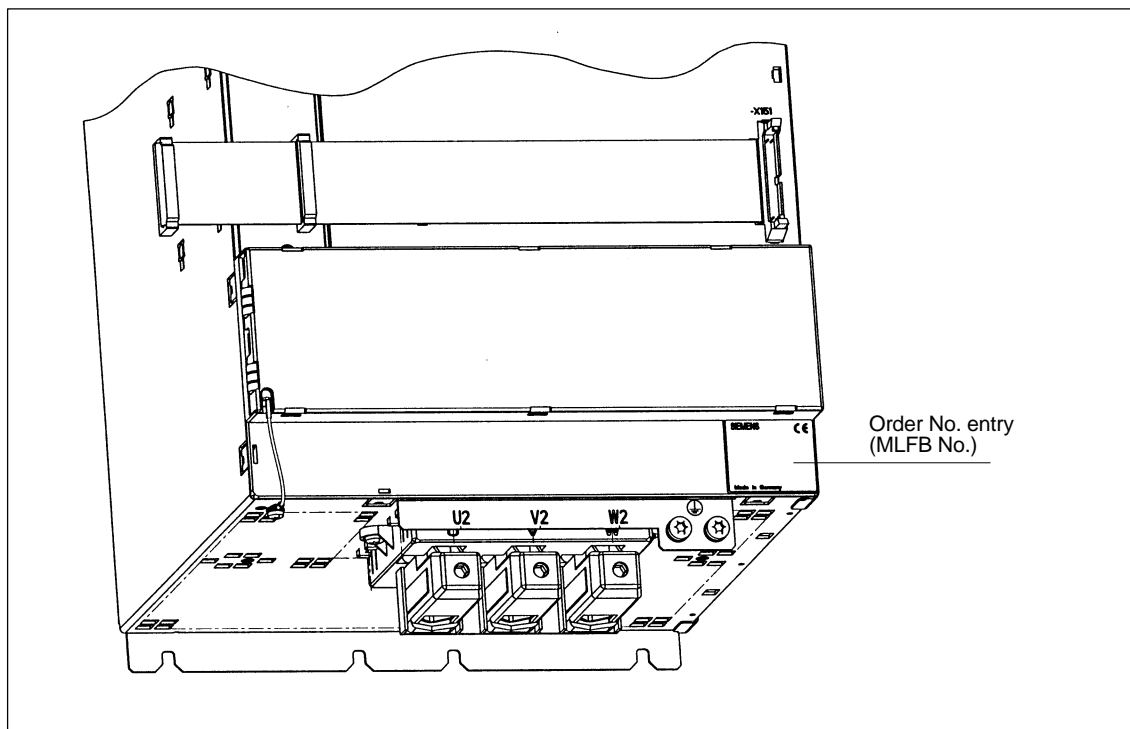

Fig. 6-1 Position of the Order No. (MLFB No.)

6.3 Connections

Overview

- Connection diagram SIMODRIVE 611 analog system
- Terminals
- Relay terminals



Warning

Cable shields and cores in power cables which are not used (e. g. brake cores) must be connected to PE potential in order to discharge charging due to capacitive coupling.

Hazardous touch voltages could occur if this is not observed.

Note: When using non-PELV circuits at terminals AS1, AS2, the connector must be prevented from being incorrectly inserted by using the appropriate connector coding (refer to EN60204–1, Section 6.4)
Order No. of the coding connector, refer to Catalog NC60

6.3 Connections

Connecting diagram
SIMODRIVE
611 analog system

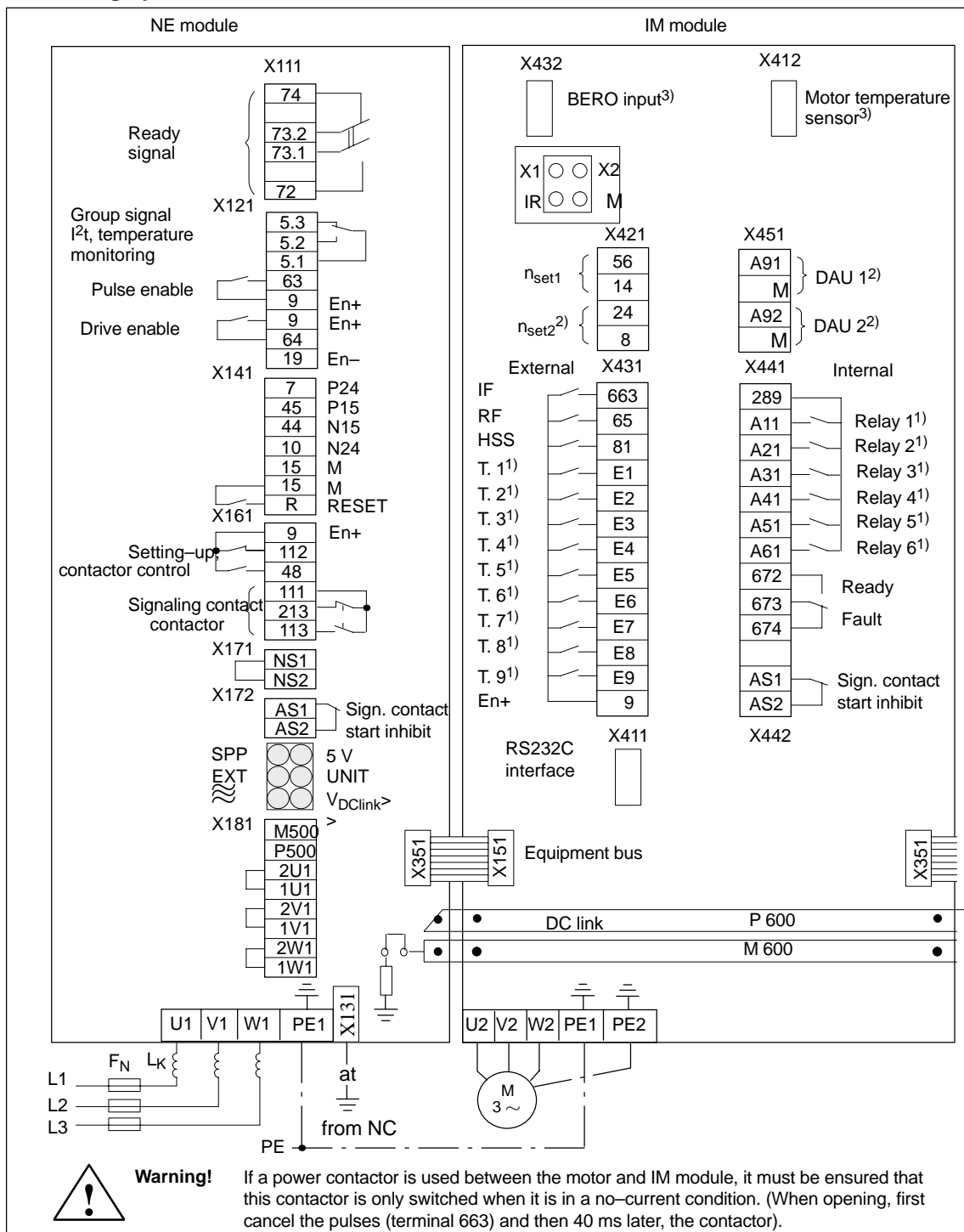

Fig. 6-2 Connection diagram

- 1) Freely-programmable inputs and outputs
- 2) Function not possible with Order No. [MLFB] 6SN1122-0BA11-0AA0
- 3) From Order No. [MLFB] 6SN112□-1A□0□-□□A1

Terminals

Table 6-2 Terminals

Terminal No.	Location	Function	Type 1)	Typ. voltage/limit values	Max. cross-section
U2 V2 W2		Motor connection	O	3-ph. 0...450 V AC	According to the Planning Guide
PE1 PE2		Protective conductor Protective conductor	I O	0 V 0 V	Stud Stud
P600 M600		DC link DC link	I/O I/O	+300 V -300 V	Busbar Busbar
	X151/351	Equipment bus	I/O	Various	Ribbon cable
56 14 24 8	X421 X421 X421 X421	} Speed setpoint 1 (Differential input) } Speed setpoint 2 (Differential input)	I I I I	} ± 10 V (max. ± 11 V) } ± 10 V (max. ± 11 V)	1.5 mm ² 1.5 mm ² 1.5 mm ² 1.5 mm ²
663 65 81 E1 E2 E3 E4 E5 E6 E7 E8 E9 9 ⁴⁾	X431 X431 X431 X431 X431 X431 X431 X431 X431 X431 X431 X431 X431	Axis-specific pulse enable Controller enable Fast ramp-funct. generator stop Freely-prog. enable terminal 1 ²⁾ Freely-prog. enable terminal 2 ²⁾ Freely-prog. enable terminal 3 ²⁾ Freely-prog. enable terminal 4 ²⁾ Freely-prog. enable terminal 5 ²⁾ Freely-prog. enable terminal 6 ²⁾ Freely-prog. enable terminal 7 ²⁾ Freely-prog. enable terminal 8 ²⁾ Freely-prog. enable terminal 9 ²⁾ Enable voltage	I I I I I I I I I I I I O	+21 V...+33 V +13 V...+30 V +13 V...+30 V +13 V...+30 V +13 V...+30 V +13 V...+30 V +13 V...+30 V +13 V...+30 V +13 V...+30 V +13 V...+30 V +13 V...+30 V +13 V...+30 V +24 V	1.5 mm ² 1.5 mm ² 1.5 mm ² 1.5 mm ² 1.5 mm ² 1.5 mm ² 1.5 mm ² 1.5 mm ² 1.5 mm ² 1.5 mm ² 1.5 mm ² 1.5 mm ² 1.5 mm ²
A91 M A92 M	X451 X451 X451 X451	Analog output DAU 1 ³⁾ Reference potential for DAU 1 ³⁾ Analog output DAU 2 ³⁾ Reference potential for DAU 2 ³⁾	O O O O	± 10 V 3 mA 0 V ± 10 V 3 mA 0 V	1.5 mm ² 1.5 mm ² 1.5 mm ² 1.5 mm ²
X1 X2 IR M		Test socket Test socket Test socket Test socket	O O O O	0 V...5 V 3 mA 0 V...5 V 3 mA ± 10 V 3 mA 0 V	Test socket, 2 mm diameter Test socket, 2 mm diameter Test socket, 2 mm diameter Test socket, 2 mm diameter

1) I = Input O = Output

2) Can be freely programmed using operator control parameters

3) Function not possible with Order No. [MLFB] 6SN1122-0BA11-0AA0

4) Refer to Section NE 3.1... 3.2

6.3 Connections

Relay terminals

Table 6-3 Relay terminals

Terminal No.	Location	Function	Type ¹⁾	Typ. voltage/limit values	Max. cross-section
289	X441	Signals, center contact	I	30 V/6.0 A max	1.5 mm ²
A11	X441	Freely-prog. relay function 1 ²⁾	NO	30 V/1.0 A max	1.5 mm ²
A21	X441	Freely-prog. relay function 2 ²⁾	NO	30 V/1.0 A max	1.5 mm ²
A31	X441	Freely-prog. relay function 3 ²⁾	NO	30 V/1.0 A max	1.5 mm ²
A41	X441	Freely-prog. relay function 4 ²⁾	NO	30 V/1.0 A max	1.5 mm ²
A51	X441	Freely-prog. relay function 5 ²⁾	NO	30 V/1.0 A max	1.5 mm ²
A61	X441	Freely-prog. relay function 6 ²⁾	NO	30 V/1.0 A max	1.5 mm ²
672	X441	} Ready/ no fault axis-specific	NO	30 V/1.0 A max	1.5 mm ²
673	X441		I	30 V/1.0 A max	1.5 mm ²
674	X441		NC	30 V/1.0 A max	1.5 mm ²
AS 1	X441	} Signaling contact Start inhibit	I	250 V _{AC} /2.9 A max	1.5 mm ²
AS 2	X441		NC	250 V _{AC} /2.9 A max	1.5 mm ²

6.4 Interfaces

6.4.1 X432 connector assignment for BERO

PIN No.	Signal name	Explanation
10	En+	+24V
14	BERO	Signal
15	En-	Ground

It is not permissible that the other pins are assigned.

6.4.2 X412 connector assignment for motor temperature sensor

PIN No.	Signal name
14	+Temp
15	-Temp

It is not permissible that the other pins are assigned.

6.4.3 X411 serial interface

PIN No.	Signal name
2	TxD
3	RxD
5	M5

AM

-
- 1) I = Input NC = NC contact NO = NO contact
 2) Can be freely-programmed using operator control parameters

6.5 RAM variable addresses

The following is valid for all address data: Segment address P-249 = 0H

Table 6-4 RAM variable addresses

Variable	Address	Value	Corresponds to	Cyclic update time
Calculated speed actual value (amount)	11B6H	7FFFH	n_{\max} (P-174/P-029)	Speed controller clock cycle as parameterized in P-090
Utilization	11B8H	7FFFH	Act. torque limit	
Actual torque limit	1110H	7FFFH	37499 RPM	
Torque setpoint	10ECH	2000H	M_{drated}	
Absolute current (actual value)	10C6H	2000H	$I_{\text{mot. rated}}$	
Absolute current (setpoint)	10C4H	2000H	$I_{\text{mot. rated}}$	
Torque-generating current (setpoint)	10D2H	2000H	$I_{\text{mot. rated}}$	
Field-generating current (setpoint)	10CAH	2000H	$I_{\text{mot. rated}}$	
Speed setpoint (after the ramp-function generator)	0E02H	7FFFH	37499 RPM	
Field angle (setpoint)	1140H	10000H	2π	
Field angle (actual value)	1142H	10000H	2π	
Active power (actual value)	1148H	2000H	$P_{\text{S rated}}$	
Reactive power (actual value)	114AH	2000H	$P_{\text{S rated}}$	
Integral component, speed controller	117CH	2000H	M_{drated}	
Integral component, field controller	116AH	2000H	$I_{\text{mot. rated}}$	
Magnetizing current (calculated)	10E6H	2000H	$I_{\text{mot. rated}}$	

6.6 Setting and monitoring data (parameter list)

 fields with gray background: Entry not possible

Dependent parameters/sub-parameters

No data generally-valid parameters
 M motor-dependent parameters
 G gearbox stage-dependent parameters
 F fixed setpoint-dependent parameters

Table 6-5 Overview of the parameters (search help for the descriptions)

P-	Sec.	Page	P-	Sec.	Page	P-	Sec.	Page	P-	Sec.	Page	P-	Sec.	Page
000	2.2.1	22	030	4.6	63	060	4.5	62	090	1.3	11	120	-	-
001	5.1.1	75	031	4.1 4.7	55 68	061	2.1	16	091	-	-	121	-	-
002	5.1.1	75	032	4.1 4.7	55 68	062	-	-	092	-	-	122	-	-
003	5.1.1	75	033	-	-	063	2.2.3	25	093	-	-	123	-	-
004	5.1.1	75	034	4.3 4.7	60 70	064	2.2.3	25	094	-	-	124	-	-
005	5.1.1	75	035	4.3 4.7	60 70	065	2.2.3	25	095	2.1	16	125	-	-
006	5.1.1	75	036	4.2	57	066	3.3.4	49	096	2.1	16	126	-	-
007	5.1.1	75	037	5.1.1	75	067	3.3.4	49	097	2.1	16	127	-	-
008	5.1.1	75	038	-	-	068	3.3.4	49	098	-	-	128	-	-
009	5.1.1	75	039	2.2.3	24	069	3.3.4	49	099	2.2.2	23	129	-	-
010	5.1.1	75	040	-	-	070	-	-	100	2.2.1	22	130	-	-
011	5.1.2	76	041	2.2.3	24	071	-	-	101	5.1.1	75	131	2.2.3	24
012	3.3.4	49	042	4.1	54	072	5.1.4	82	102	5.1.1	75	132	2.2.3	24
013	3.3.4	49	043	4.1	54	073	5.1.4	82	103	-	-	133	5.1.1	75
014	3.1	38	044	-	-	074	5.1.4	82	104	-	-	134	-	-
015	3.1	38	045	-	-	075	-	-	105	-	-	135	-	-
016	4.1	54	046	-	-	076	5.1.4	82	106	-	-	136	-	-
017	4.1	54	047	3.3.2	46	077	5.1.4	82	107	-	-	137	-	-
018	4.1	54	048	-	-	078	3.3.4	49	108	-	-	138	-	-
019	3.1	38	049	4.2	57	079	3.3.4	49	109	-	-	139	-	-
020	5.1.3	79	050	4.5	62	080	5.1.4	82	110	5.1.1	75	140	-	-
021	3.3.2	46	051	1.3	10	081	3.2.2	41	111	-	-	141	-	-
022	2.2.3	23	052	1.3	10	082	3.2.2	41	112	-	-	142	-	-
023	3.3.2	46	053	1.3	10	083	3.2.2	41	113	3.1	37	143	-	-
024	3.1	38	054	4.6	63	084	3.2.2	41	114	3.1	38	144	-	-
025	3.1	38	055	4.6	63	085	3.2.2	41	115	4.2 4.7	58 65	145	-	-
026	-	-	056	2.3	27	086	3.2.2	41	116	4.2 4.7	58 65	146	-	-
027	3.3.2	46	057	4.4	61	087	3.2.2	41	117	-	-	147	-	-
028	5.1.3	80	058	4.4	61	088	3.2.2	41	118	-	-	148	-	-
029	2.2.3	23	059	4.5	62	089	3.2.2	41	119	3.1	38	149	-	-

6.6 Setting and monitoring data (parameter list)

Table 6-5 Overview of the parameters (search help for the descriptions), continued

P–	Sec.	Page	P–	Sec.	Page	P–	Sec.	Page	P–	Sec.	Page	P–	Sec.	Page
150	–	–	180	–	–	210	5.1.6	85	240	–	–			
151	1.3	10	181	5.1.5	83	211	5.1.6	85	241	3.3.2	44			
152	1.3	10	182	5.1.5	83	212	5.1.6	84	242	3.3.2	44			
153	1.3	12	183	5.1.5	83	213	5.1.6	84	243	3.3.2	44			
154	2.2.3	26	184	–	–	214	5.1.6	85	244	3.3.2	44			
155	2.2.3	26	185	3.3.3	47	215	5.1.6	85	245	3.3.2	44			
156	2.2.3	26	186	3.3.3	47	216	5.1.6	85	246	3.3.2	44			
157	2.2.3	26	187	3.3.3	47	217	5.1.6	85	247	3.3.2	46			
158	2.1 2.3	17 29	188	3.3.3	47	218	5.1.6	85	248	–	–			
159	4.1	56	189	3.3.3	47	219	4.1	65	249	2.5	36			
160	2.1 2.3	17 29	190	3.3.3	47	220	–	–	250	2.5	36			
161	2.1 2.3	17 29	191	3.3.3	47	221	–	–	251	2.5	36			
162	2.1 2.3	17 29	192	3.3.3	47	222	–	–	252	–	–			
163	2.1 2.3	17 29	193	3.3.3	47	223	–	–	253	–	–			
164	2.1 2.3	17 29	194	3.3.3	47	224	–	–	254	5.1.2	77			
165	–	–	195	4.1	55	225	–	–	255	5.1.2	78			
166	4.2	59	196	4.1	55	226	–	–						
167	2.1 2.3	17 30	197	4.1	55	227	–	–						
168	2.1 2.3 4.7	17 30 74	198	4.1	55	228	–	–						
169	2.1 2.3	17 30	199	4.1	55	229	–	–						
170	2.1 2.3	17 30	200	5.1.3	80	230	–	–						
171	2.1 2.3 4.7	18 30 72	201	–	–	231	–	–						
172	2.1 2.3	18 30	202	–	–	232	–	–						
173	2.1 2.3	18 31	203	4.1	55	233	–	–						
174	2.1 2.3	18 29	204	4	51	234	–	–						
175	2.2.3	25	205	4	51	235	–	–						
176	2.1 2.3	18 31	206	5.1.6	85	236	–	–						
177	–	–	207	5.1.6	84	237	–	–						
178	2.1 2.3	18 29	208	5.1.6	85	238	–	–						
179	5.1.5	83	209	5.1.6	85	239	–	–						

P No.	Designation	Sec.	Firm-ware rel.	Setting range	Default	Dim.	Setting values							
							1	2	3	4	5	6	7	8
(P-000)	Operating display	2.2.1	1.10	Special character	–	–								
(P-001)	Speed setpoint	5.1.1	1.10	–32000...32000	–	RPM								
(P-002)	Speed actual value	5.1.1	1.10	–32000...32000	–	RPM								
(P-003)	Torque-generating current	5.1.1	1.10	–399,0...399,0	–	%								
(P-004)	Utilization	5.1.1	1.10	0,0...100,0	–	%								
(P-005)	Motor frequency	5.1.1	1.10	–1250...1250	–	Hz								
(P-006)	DC link voltage	5.1.1	1.10	0...700	–	V								
(P-007)	Motor current	5.1.1	1.10	0,0...399,0	–	%								
(P-008)	Field current component	5.1.1	1.10	0,0...399,0	–	%								
(P-009)	Active power	5.1.1	1.10	–399,0...399,0	–	%								
(P-010)	Voltage actual value	5.1.1	1.10	0,0...450,0	–	V								
(P-011)	Status of the digital inputs	5.1.2	1.10	0...FFFF	–	hex								
P-012	Normalization DAU channel 1	3.3.4	1.10	–1000,0...1000,0	100,0	%								
P-013	Normalization DAU channel 2	3.3.4	1.10	–1000,0...1000,0	100,0	%								
P-014	Speed for max. motor useful speed	M	3.1	1.10	–32000...32000	$n_{\max\text{Mot}}$	RPM							
P-015	Offset correction, setpoint channel 1	3.1	1.10	E000...2000	0	hex								
P-016	Ramp-up time, ramp-function generator 1	M	4.1	1.10	0,00...320,00	0,00	s							
P-017	Ramp-down time, ramp-funct. generator 1	M	4.1	1.10	0,00...320,00	0,00	s							
P-018	Initial rounding-off	M	4.1	1.10	4,00...100,00	0,00	ms							
P-019	Offset correction, setpoint channel 2	3.1	1.10	E000...2000	0	hex								
(P-020)	Executed automatic setting routine	M	5.1.3	1.10	0...00FF	–	hex							
P-021	n_{\min} for " $n_{\text{act}} < n_{\min}$ " signal	G	3.3.2	1.10	2...16000	10	RPM							
P-022	Shutdown speed, pulse cancellation	M	2.2.3	1.10	2...16000	8	RPM							
P-023	n_x for " $n_{\text{act}} < n_x$ " signal	G	3.3.2	1.10	0...32000	3000	RPM							
P-024	Normalization, setpoint channel 1	3.1	1.10	2,0...10,0	10,0	V								
P-025	Normalization, setpoint channel 2	3.1	1.10	2,0...10,0	10,0	V								
P-027	Tolerance bandwidth f. " $n_{\text{set}} = n_{\text{act}}$ " signal	G	3.3.2	1.10	0...32000	100	RPM							
(P-028)	Diagnostics	5.1.3	1.10	0...FFFF	–	hex								

P No.	Designation	Sec.	Firm-ware rel.	Setting range	Default	Dim.	Setting value								
							1	2	3	4	5	6	7	8	
P-029	Speed limiting	G	2.2.3	1.10	0...32000	6000	RPM								
P-030	Steady-state minimum speed	M	4.6	1.10	0...32000	0	RPM								
P-031	P gain, speed controller	M	4.1	1.10	0,0...255,9	50,0	dec								
P-032	Integral action time, speed controller	M	4.1	1.10	10,0...6000,0	140,0	ms								
P-034	P gain, field controller	M	4.3	1.10	0,0...600,0	40,0	100 AVs								
P-035	Integral action time, field controller	M	4.3	1.10	5,0...600,0	30,0	ms								
P-036	Inverter clock cycle frequency	M	4.2	1.10	0...7	0	hex								
P-037	Actual inverter clock cycle frequency	5.1.1	3.0		2,8...7,8	-	kHz								
P-039	1st torque limit value	G	2.2.3	1.10	0...399	100	%								
P-041	2nd torque limit value	G	2.2.3	1.10	0...399	50	%								
P-042	Ramp-up time, ramp-function generator 2	M	4.1	1.10	0,00...320,00	5,00	s								
P-043	Ramp-down time, ramp-function generator 2	M	4.1	1.10	0,00...320,00	5,00	s								
P-047	M _{dx} for "M _d < M _{dx} " signal	G	3.3.2	1.10	0,0...100,0	90,0	%								
(P-049)	Current limiting with de-rating	2.4	3.10		0...399	-	%								
P-050	Switching speed from M _{d1} to M _{d2}	G	4.5	1.10	0...32000	6000	RPM								
P-051	Write protection	1.3	1.10		0...7FFF	0	hex								
P-052	Transfer parameter into FEPR0M	1.3	1.10		0...1	0	dec								
P-053	Control word	1.3	1.10		0...FFFF	1	hex								
P-054	Range suppression, lower speed	M	4.6	1.10	0...32000	0	RPM								
P-055	Range suppression, upper speed	M	4.6	1.10	0...32000	0	RPM								
P-056	Motor selection	2.3	1.10		0...4	0	dec								
P-057	Current setpoint f. the open-loop contr.range	M	4.4	1.10	0...150	90	%								
P-058	Acc. torque in the open-loop controlled range	M	4.4	1.10	0...399	100	%								
P-059	Current limiting	M	4.5	1.10	0...399	100	%								
P-060	Power limiting	M	4.5	1.10	0...399	100	%								
P-061	Fixed DC link voltage	2.1	1.10		0...700	0	V								
P-063	Max. motor temperature (KTY84)	M	2.2.3	3.00	0...170	150	deg. C								
P-064	Fixed temperature	2.2.3	3.00		0...170	30	deg. C								
P-065	Timer stage, motor temperature alarm	2.2.3	3.00		0...600	240	s								

P No.	Designation	Sec.	Firm-ware rel.	Setting range	Default	Dim.	Setting value							
							1	2	3	4	5	6	7	8
P-066	Address, DAU 1	3.3.4	1.10	0...FFFF	11B6	hex								
P-067	Shift factor, DAU 1	3.3.4	1.10	0...F	0	hex								
P-068	Address, DAU 2	3.3.4	1.10	0...FFFF	11B8	hex								
P-069	Shift factor, DAU 2	3,3.4	1.10	0...F	0	hex								
P-072	Address, DAU 4	5.1.4	1.10	0...FFFF	10D2	hex								
P-073	Shift factor, DAU 4	5.1.4	1.10	0...F	0	hex								
P-074	Offset, DAU 4	5.1.4	1.10	-127...127	0	Incr.								
P-076	Address, DAU 3	5.1.4	1.10	0...FFFF	1110	hex								
P-077	Shift factor, DAU 3	5.1.4	1.10	0...F	0	hex								
P-078	Offset DAU 1	3.3.4	1.10	-127...127	0	Incr.								
P-079	Offset DAU 2	3.3.4	1.10	-127...127	0	Incr.								
P-080	Offset DAU 3	5.1.4	1.10	-127...127	0	Incr.								
P-081	Terminal function assignment E1	3.2.2	1.10	1...21	1	dec								
P-082	Terminal function assignment E2	3.2.2	1.10	1...21	7	dec								
P-083	Terminal function assignment E3	3.2.2	1.10	1...21	3	dec								
P-084	Terminal function assignment E4	3.2.2	1.10	1...21	17	dec								
P-085	Terminal function assignment E5	3.2.2	1.10	1...21	18	dec								
P-086	Terminal function assignment E6	3.2.2	1.10	1...21	19	dec								
P-087	Terminal function assignment E7	3.2.2	1.10	1...21	9	dec								
P-088	Terminal function assignment E8	3.2.2	1.10	1...21	10	dec								
P-089	Terminal function assignment E9	3.2.2	1.10	1...21	11	dec								
P-090	Control word	1.3	1.10	0...FFFF	000D	hex								
P-095	Power module code number	2.1	1.10	1...13	3	dec								
P-096	Motor code number	M 2.1	1.10	0...7	0	dec								
P-097	Initialization	2.1	1.10	0...1	0	hex								
(P-099)	Firmware release	2.2.2	1.10	0,00...99,99	-	dec								
(P-100)	Operating display	2.2.1	1.10	Special characters	-	-								
(P-101)	Speed setpoint	5.1.1	1.10	-32000...32000	-	RPM								

P No.	Designation	Sec.	Firm-ware rel.	Setting range	Default	Dim.	Setting value							
							1	2	3	4	5	6	7	8
(P-102)	Speed actual value	5.1.1	1.10	-32000...32000	-	RPM								
(P-110)	Motor temperature	5.1.1	3.00	0...170		deg. C								
P-113	Channel selection, speed setpoint	3.1	1.10	0...9	1	dec								
P-114	Fixed setpoints 1 to 7	F 3.1	1.10	-32000...32000	0	RPM								
P-114	Motorized potentiometer setpoint	3.1	1.10	-32000...32000	0	RPM								
P-115	P gain, current controller, base speed range	M 4.2	1.10	0...255	2	dec								
P-116	P gain, current controller, field-weaken. range	M 4.2	1.10	0...300	2	dec								
P-119	Fixed setpoints 8 to 15	F 3.1	2.00	-32000 ... 32000	0	RPM								
P-131	Pulse number, speed monitoring BERO	M 2.2.3	3.00	0...10	0									
P-132	Shutdown threshold, speed monitoring BERO	M 2.2.3	3.00	0...65535	65535	RPM								
(P-133)	Absolute speed actual value BERO	5.1.1	3.00	0...65535		RPM								
P-151	Write protection	1.3	1.10	0...7FFF	0	hex								
P-152	Transfer parameter into FEPROM	1.3	1.10	0...1	0	dec								
P-153	Calculate motor data/controller data	1.3	1.10	-1...1	0	dec								
P-154	Oscillation setpoint 1	2.2.3	1.10	-32000...32000	0	RPM								
P-155	Oscillation setpoint 2	2.2.3	1.10	-32000...32000	0	RPM								
P-156	Oscillation interval time 1	2.2.3	1.10	0,002...60,000	1,000	s								
P-157	Oscillation interval time 2	2.2.3	1.10	0,002...60,000	1,000	s								
P-158	Inductance, series reactor	M 2.1	1.10	0,000...65,000	0,000	mH								
P-159	Moment of inertia, motor and external	M 4.1	1.10	0,0...6535,5	0,0	gm ²								
P-160	Rated motor output	M 2.1	1.10	0,00...650,00	0,00	kW								
P-161	Rated motor current	M 2.1	1.10	0,00...650,00	0,00	A								
P-162	Rated motor voltage	M 2.1	1.10	0,00...650,00	379,00	V								
P-163	Rated motor speed	M 2.1	1.10	0...65000	1500	RPM								
P-164	Rated motor frequency	M 2.1	1.10	0,0...1200,0	50,0	Hz								
P-166	No-load motor current	M 4.2	1.10	0,00...I rated PM	0,00	A								
P-167	Stator resistance, cold	M 2.1	1.10	0,000...65,000	0,000	Ω								
P-168	Rotor resistance, cold	M 2.1	1.10	0,000...65,000	0,000	Ω								
P-169	Stator leakage reactance	M 2.1	1.10	0,000...65,000	0,000	Ω								

P No.	Designation	Sec.	Firm-ware rel.	Setting range	Default	Dim.	Setting values									
							1	2	3	4	5	6	7	8		
P-170	Rotor leakage reactance	M	2.1	1.10	0,000...65,000	0,000	Ω									
P-171	Magnetizing reactance	M	2.1	1.10	0,00...650,00	0,00	Ω									
P-172	Changeover speed closed-loop/open-loop ctrl	M	2.1	1.10	0...32000	300	RPM									
P-173	Speed at the start of field weakening	M	2.1	1.10	0...32000	1500	RPM									
P-174	Max. motor speed	M	2.1	1.10	0...32000	1500	RPM									
P-175	Thermal motor time constant	M	2.2.3	1.10	0,0...500,0	1,0	min									
P-176	Speed at the start of the stall torque	M	2.1	1.10	0...65535	32767	RPM									
P-178	Power factor cos φ	M	2.1	1.10	0,000...1,000	0,800	-									
P-179	Selection, min/max memory		5.1.5	1.10	0...3	0	hex									
P-181	Address for min/max memory		5.1.5	1.10	0...FFFF	1110	hex									
(P-182)	Min. value, min/max memory		5.1.5	1.10	0...FFFF	-	hex									
(P-183)	Max. value, min/max memory		5.1.5	1.10	0...FFFF	-	hex									
P-185	Address for monitoring 1		3.3.3	1.10	0...FFFF	1110	hex									
P-186	Threshold for monitoring 1		3.3.3	1.10	0...FFFF	0	hex									
P-187	Pull-in delay, monitoring 1		3.3.3	1.10	0,00...10,00	0,00	s									
P-188	Drop-out delay, monitoring 1		3.3.3	1.10	0,00...10,00	0,00	s									
P-189	Hysteresis, monitoring 1		3.3.3	1.10	0...7FFF	1	hex									
P-190	Address for monitoring 2		3.3.3	1.10	0...FFFF	1110	hex									
P-191	Threshold for monitoring 2		3.3.3	1.10	0...FFFF	0	hex									
P-192	Pull-in delay, monitoring 2		3.3.3	1.10	0,00...10,00	0	s									
P-193	Drop-out delay, monitoring 2		3.3.3	1.10	0,00...10,00	0	s									
P-194	Hysteresis, monitoring 2		3.3.3	1.10	0...7FFF	1	hex									
P-195	Lower adaptation speed	M	4.1	1.10	0...32000	0	RPM									
P-196	Upper adaptation speed	M	4.1	1.10	0...32000	0	RPM									
P-197	P gain, lower adaptation speed	M	4.1	1.10	0,0...255,9	50,0	dec									
P-198	P gain, upper adaptation speed	M	4.1	1.10	0,0...255,9	10,0	dec									
P-199	P gain, reduction factor	M	4.1	1.10	1...150	100	%									
(P-200)	Checksum parameter		5.1.3	2.00	0 ... FFFF	-	hex									
P-203	Select adaptation, speed controller	M	4.1	1.10	0...1	0	dec									

P No.	Designation	Sec.	Firm-ware rel.	Setting range	Default	Dim.	Setting value							
							1	2	3	4	5	6	7	8
P-204	Automatic optimization, function selection	4	1.10	0...7	0	dec								
P-205	Start automatic optimization	4	1.10	0...1	0	dec								
P-206	Select transient recorder	5.1.6	1.10	0...1	0	hex								
P-207	Set transient recorder	5.1.6	1.10	0...C	0	hex								
P-208	Address for start condition	5.1.6	1.10	0...FFFF	0	hex								
P-209	Threshold for start condition	5.1.6	1.10	0...FFFF	0	hex								
P-210	Address for stop condition	5.1.6	1.10	0...FFFF	0	hex								
P-211	Threshold for stop condition	5.1.6	1.10	0...FFFF	0	hex								
P-212	Address, signal 1	5.1.6	1.10	0...FFFF	1110	hex								
P-213	Address, signal 2	5.1.6	1.10	0...FFFF	10D2	hex								
P-214	Start output of trace record	5.1.6	1.10	0...1	0	hex								
P-215	Shift factor, signal 1	5.1.6	1.10	0...15	0	dec								
P-216	Shift factor, signal 2	5.1.6	1.10	0...15	0	dec								
P-217	Trigger signal 1	5.1.6	1.10	0...FFFF	0	hex								
P-218	Trigger signal 2	5.1.6	1.10	0...FFFF	7FFF	hex								
P-219	Supplementary moment of inertia	M	4.1	2.00	0 ... 15	0	kgm ²							
P-241	Programmable message 1	3.3.2	1.10	1...20	20	dec								
P-242	Programmable message 2	3.3.2	1.10	1...20	3	dec								
P-243	Programmable message 3	3.3.2	1.10	1...20	1	dec								
P-244	Programmable message 4	3.3.2	1.10	1...20	4	dec								
P-245	Programmable message 5	3.3.2	1.10	1...20	5	dec								
P-246	Programmable message 6	3.3.2	1.10	1...20	2	dec								
P-247	Control word message	3.3.2	1.10	0...FFFF	0	hex								
P-249	Segment, memory location monitor	2.5	1.10	0...FFFF	0	hex								
P-250	Address, memory location monitor	2.5	1.10	0...FFFF	0	hex								
(P-251)	Value display, memory location monitor	2.5	1.10	0...FFFF										
(P-254)	Display, active functions 1	5.1.2	1.10	0...FFFF	-	hex								
(P-255)	Display, active functions 2	5.1.2	1.10	0...FFFF	-	hex								

Customer:		Machine:			Date:	
Initialization values and motor type						
Parameters		No.	Value			Comment
Power module code number	P-095		IM module:	/	/	A
Motor code number	P-096	0	Motor type:			2p =
Motor selection	P-056		Motor parameter set:			Deep bar squirrel-cage rotor yes/no
Firmware release	P-099					Changeover with/without pulse cancellation
Motor data						
Parameters		No.	Rating plate data	Unit	Comment	
Rated motor output	P-160			kW		
Rated motor current	P-161			A		
Rated motor voltage	P-162			V		
Rated motor speed	P-163			RPM		
Rated motor frequency	P-164			Hz		
Max. motor speed	P-174			RPM		
Power factor $\cos \phi$	P-178			dec		
Circuit configuration Υ / Δ						Jumpers in the terminal box
Equivalent circuit diagram data						
Parameters		No.	Calculated value P-153 = +1	Self-optimized value P-204 =	Post-optimized value	Unit
No-load motor current	P-166		3			A
Stator resistance, cold	P-167					Ω
Rotor resistance, cold	P-168		6			Ω
Stator leakage reactance	P-169					Ω
Rotor leakage reactance	P-170					Ω
Magnetizing reactance	P-171		4			Ω
Changeover speed, closed-loop/open-loop control	P-172					RPM
Speed at the start of field weakening	P-173		8			RPM
Speed at the start of stall torque	P-176		8			RPM
Controller data						
Parameters		No.	Calculated value P-153 = -1	Self-optimized value P-204 =	Post-optimized value	Unit
P gain, speed controller	P-031			7		dec
Integral action time, speed controller	P-032		140	7		ms
P gain, field controller	P-034					100 A/Vs
Integral action time, field controller	P-035					ms
P gain, current controller, base speed range	P-115			1		dec
P gain, current controller, field-weakening range	P-116			1		dec
Moment of inertia, motor and external	P-159			5		gm ²
Additional moment of inertia	P-219			5		kgm ²
Offset, active power	P-250 =	(P-251)		2		hex
Offset, reactive power	P-250 =	(P-251)		2		hex
Special settings						
Parameters		No.	Value	Unit	Comment	
Initial rounding-off	P-018			ms		
Drive converter switching frequency	P-036			hex		
Inductance of the series reactor	P-158			mH		

Index**A**

Analog outputs, AM/3-48
 connection for analog displays, AM/3-50
 parameterization DAU, AM/3-49

C

Changeover speed, AM/2-18, AM/2-21
 Connections, AM/1-14
 connecting diagram, AM/6-104
 relay terminals, AM/6-106
 terminals, AM/6-105
 Control parameter, AM/1-10
 Current controller, AM/4-57
 Current/Hz control, AM/5-86

D

DAU, AM/3-48
 DC link voltage, AM/2-16
 De-rating, AM/4-57
 De-rating for inverter clock cycle frequencies > 3.2 kHz, AM/4-58
 Diagnostic parameters, AM/5-79
 Diagnostics, AM/5-75
 Display, AM/2-22, AM/5-87
 Display parameters, AM/2-22

F

Fault, AM/5-88
 acknowledgement, AM/5-87
 display, AM/5-87
 suppression, AM/5-87
 Fault message, AM/5-88
 Field controller, AM/4-60, AM/4-70
 Field weakening range, AM/2-21
 Field-weakening range, AM/4-66
 Firmware release, AM/2-23
 Fixed setpoint, AM/3-38

G

Gearbox stage, AM/2-22

I

Initialization, AM/2-16, AM/2-21
 Input terminals, AM/3-40
 Interfaces, AM/6-107

Inverter clock cycle frequency, AM/4-57

L

Limits, AM/4-62

M

Magnetizing reactance, AM/2-18, AM/4-72
 Manual optimization, AM/4-65
 Max. speed monitoring, AM/2-23
 Measured value displays, AM/5-75
 Minimum speed, steady-state, AM/4-63
 Minimum/maximum value memory, AM/5-83
 Moment of inertia, AM/2-17, AM/4-56, AM/6-98
 Monitor function, AM/2-36
 Motor changeover, AM/2-32
 Motor data set, AM/2-17
 Motor rotor resistance, AM/4-74
 Motor rotor resistance, cold, AM/2-17
 Motor temperature emulation, AM/2-25
 Motorized potentiometer, AM/3-37
 Multi-motor operation, AM/2-27

N

No-load current, AM/4-71
 No-load motor current, AM/4-59, AM/4-71

O

Open-loop controlled range, AM/4-61
 Operating display, AM/2-22
 Operating mode, AM/2-22
 Operator and display elements, AM/1-9
 Optimization, open-loop controlled range, AM/4-61
 Oscillation operation, AM/2-26
 Output terminals, AM/3-43

P

Parallel operation, AM/2-27
 Parameter
 attributes, AM/1-5
 list, AM/1-5
 number, AM/1-9
 Parameter list, AM/6-109
 Parameter set changeover, AM/2-32
 Parameters
 setting range, AM/1-5, AM/1-6
 sub-parameter number, AM/1-9
 value, AM/1-9
 write protection, AM/1-6
 Power module code number, AM/2-16

Index

R

RAM variable, AM/6-108
RAM variable addresses, AM/6-108
Ramp–function generator, AM/4-54
 tracking, AM/4-54
Rating plate, AM/1-14
Re–initializing drive converter, AM/1-7
Relay function, AM/2-22
 permanently–connected, AM/3-43
Relay functions
 control word, signals, AM/3-46
 freely–programmable, AM/3-44
 parameterizable signals, AM/3-46
 variable, AM/3-47
Replacing components, AM/1-8
Replacing modules, AM/1-8
Replacing the firmware, AM/1-7
RS232C interface, AM/1-7, AM/1-14

S

Series machines, AM/1-8
Setpoint priority, AM/3-39
Setpoint source, AM/2-22
Setting and monitoring data, AM/6-109
Setting data, AM/1-13
Shutdown without reverse rotation, AM/4-64
Shutdown, without reverse rotation, AM/3-40
Speed controller
 adaptation, AM/4-55
 gain, AM/4-55
 integral action time, AM/4-55
Speed controller clock cycle, AM/4-56
Speed range suppression, AM/4-64

Speed ranges, AM/4-63
Speed setpoint interfaces, AM/3-37
 channel selection, AM/3-37
 setpoint priority, AM/3-39
Speed setting values, AM/2-23
Standard applications, AM/1-4, AM/2-22
 setting parameters, AM/2-23
Standardanwendungen, AM/2-26
Start–up
 instructions, AM/1-7
 new start–up, AM/6-92
 possibilities, AM/1-7
Status display
 active functions 1, AM/5-77
 active functions 2, AM/5-78
 digital inputs, AM/5-76
Steady–state minimum speed, AM/4-63
Sub–parameter number, AM/1-9

T

Terminal function
 assignment, AM/3-41
 freely–programmable, AM/3-41
 permanently–connected, AM/3-40
Test sockets, AM/5-80
Torque limit value, AM/2-24
Total moment of inertia, AM/4-56
Transient recorder function, AM/5-84

U

Unit status, AM/2-22

Spare parts (ES)

1	Components	ES/1-3
2	Accessories	ES/2-5
2.1	Connectors	ES/2-5
2.2	Cables	ES/2-6
2.3	Fuses	ES/2-6
2.4	Connecting clamps for cable shields	ES/2-7

Components

1

All of the components available in accordance with Catalogs NC60 and NC Z (motors, modules, control boards, cables, connectors etc.) should be ordered as spare parts.

Order designation of the documentation:

SINUMERIK 840D/840Di/810D/802S, C, D

Ordering Documentation

Catalog NC 60

Order No.: E86060–K4460–A101–A8

Order No.: E86060–K4460–A101–A8–7600 (English)

SINUMERIK, SIMODRIVE & SIMOVERT MASTERDRIVES

Termination System & System Components

Catalog NC Z

Order No.: E86060–K4490–A001–A7

Order No.: E86060–K4490–A001–A7–7600 (English)



Accessories

2

2.1 Connectors

Customer interface The external signals are available at the individual modules at connectors with various pins. The position and pin number of the connectors is shown in the brief references on the modules in Attachment A.

When required, the connectors, listed in Table 2-1 (customer interfaces) can be ordered as spare parts.

Table 2-1 Connectors

Pin No./connector type	Grid pattern	Order No. [MLFB]
2	5.08	6SY9433
3	5.08	6SY9906
4	5.08	6SY9432
6	5.08	6SY9896
7	5.08	6SY9898
8	5.08	6SY9897
8 ¹⁾	7.60	6SY9900
12	5.08	6SY9901
13	5.08	6SY9903
15	5.08	6SY9902
Power connector, motor connection	3 pin	6SY9904
Power connector, pulsed resistor connection	3 pin	6SY9905

BERO connector, temperature sensor

The external radial fan is connected using a connector which comprises the following AMP components:

Connector housing Mate–N–Lok	350766–1
Crimped contacts	926884–1

1) Only for connector X181 at line supply infeed modules

2.2 Cables

Equipment bus cable to adapt the module configuration:

- 50 mm Order No. 6FC5247-0AA23-0AA0
- 400 mm Order No. 6SN1161-1AA00-0BA0

Note

Equipment bus cables >50 mm can only be replaced, for mechanical design reasons, with an equipment bus cable, length 400 mm.

2.3 Fuses

Refer to the Planning Guide for recommended line supply fuses.

References

SIMODRIVE 611-A/611-D

Planning Guide Drive Converter (08.98 Edition)

Transistor PWM Converters for AC Feed Drives and
AC Main Spindle Drives

Order No.: 6SN1 197-0AA00-0BP4

2.4 Connecting clamps for cable shields

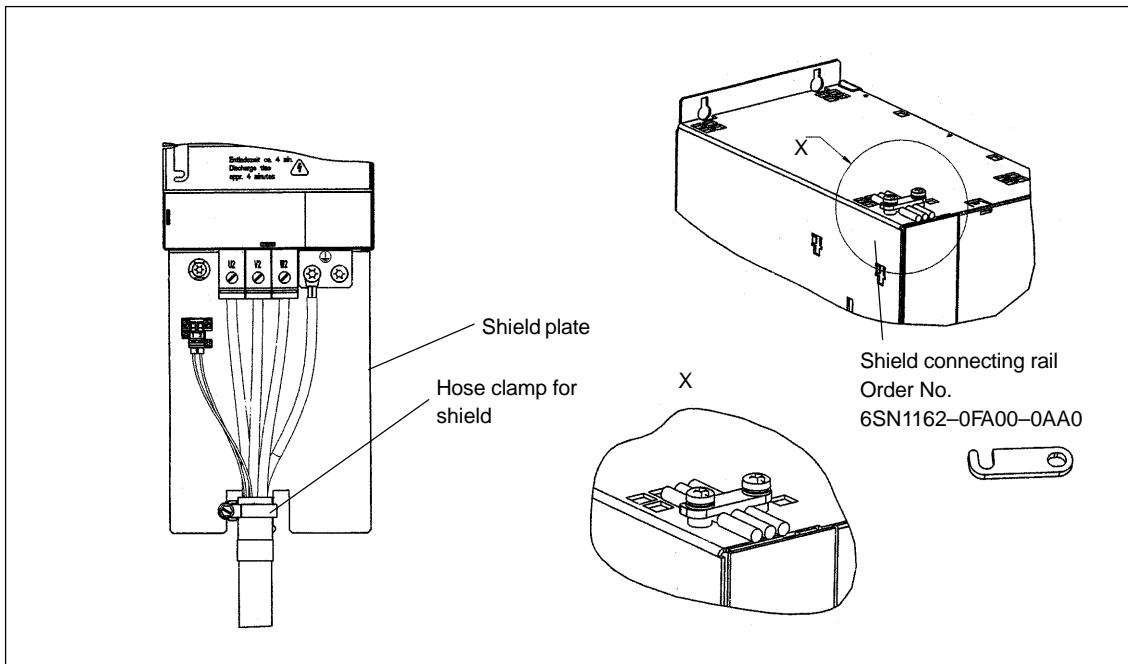

Fig. 2-1 Cable clamps for cable shields

The cable clamps are defined corresponding to the outer cable shield diameter. A list of possible hose clamps to connect cable shields is provided below.

Table 2-2 Hose clamps for the shield

Cable cross section	Hose clamp for shield
4 x 1.5 mm ² 4 x 1.5 mm ² + 2 x 1 mm ²	Hose clamp DIN 3017-AL-8-16 W1-1
4 x 2.5 mm ² + 2 x 1 mm ²	Hose clamp DIN 3017-AL-8-16 W1-1
4 x 4 mm ² 4 x 4 mm ² + 2 x 1 mm ²	Hose clamp DIN 3017-AL-12-20 W1-1
4 x 6 mm ² 4 x 6 mm ² + 2 x 1 mm ²	Hose clamp DIN 3017-AL-16-25 W1-1
4 x 10 mm ² 4 x 10 mm ² + 2 x 1 mm ²	Hose clamp DIN 3017-AL-16-25 W1-1
4 x 16 mm ² 4 x 16 mm ² + 2 x 1 mm ²	Hose clamp DIN 3017-AL-16-25 W1-1
4 x 25 mm ² + 2 x 1.5 mm ²	Hose clamp DIN 3017-AS-25-40 W1-1
4 x 35 mm ² + 2 x 1.5 mm ²	Hose clamp DIN 3017-AS-25-40 W1-1
4 x 50 mm ² + 2 x 1.5 mm ²	Hose clamp DIN 3017-AS-32-50 W1-1

User-friendly interface

Feed module (FD) with main spindle option

Standard interface

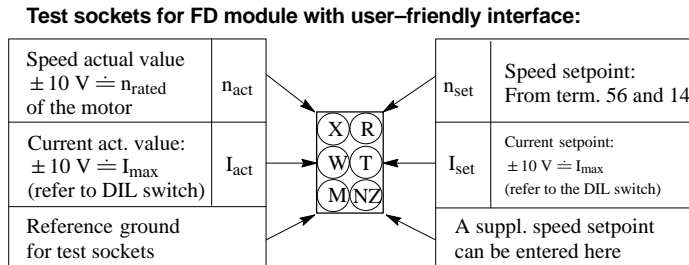
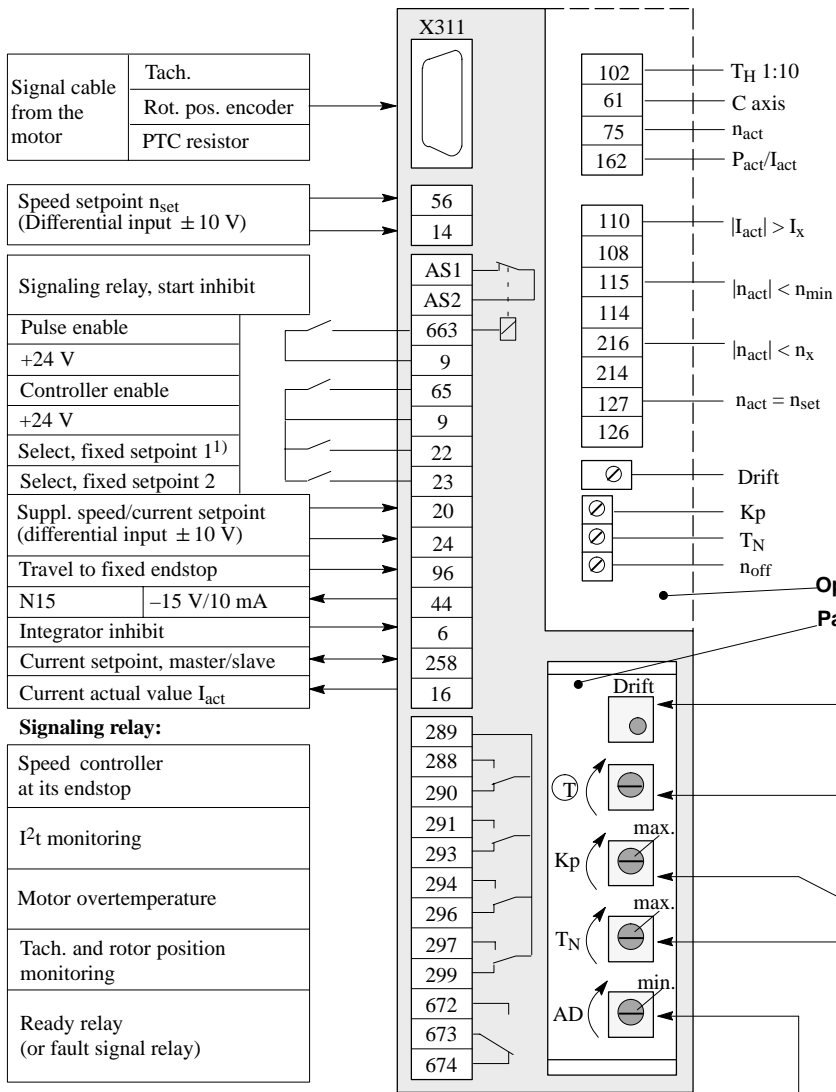

Fault messages for feed module with user-friendly interface:

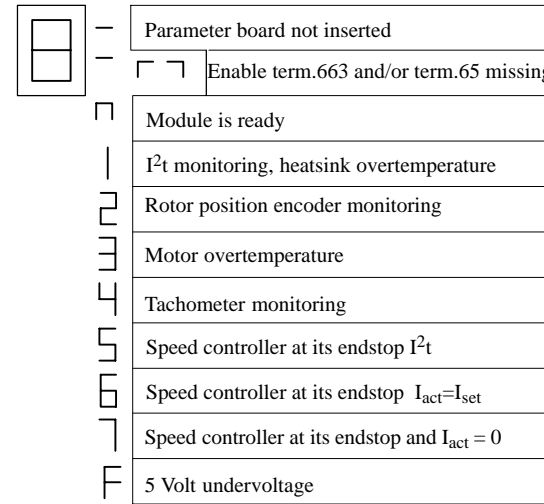

Option board, main spindle functions
Parameter board

Drift adjustment:
 Short-circuit terminals 56 and 14: The motor should not rotate

Tach. adjustment:
 Normally: The motor reaches n_{rated} at $n_{\text{set}} = 9\text{ V}$ at term.56/14.

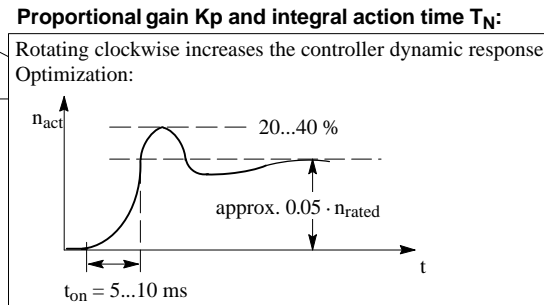

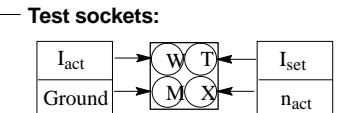
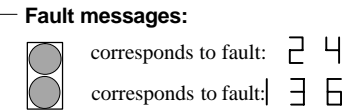
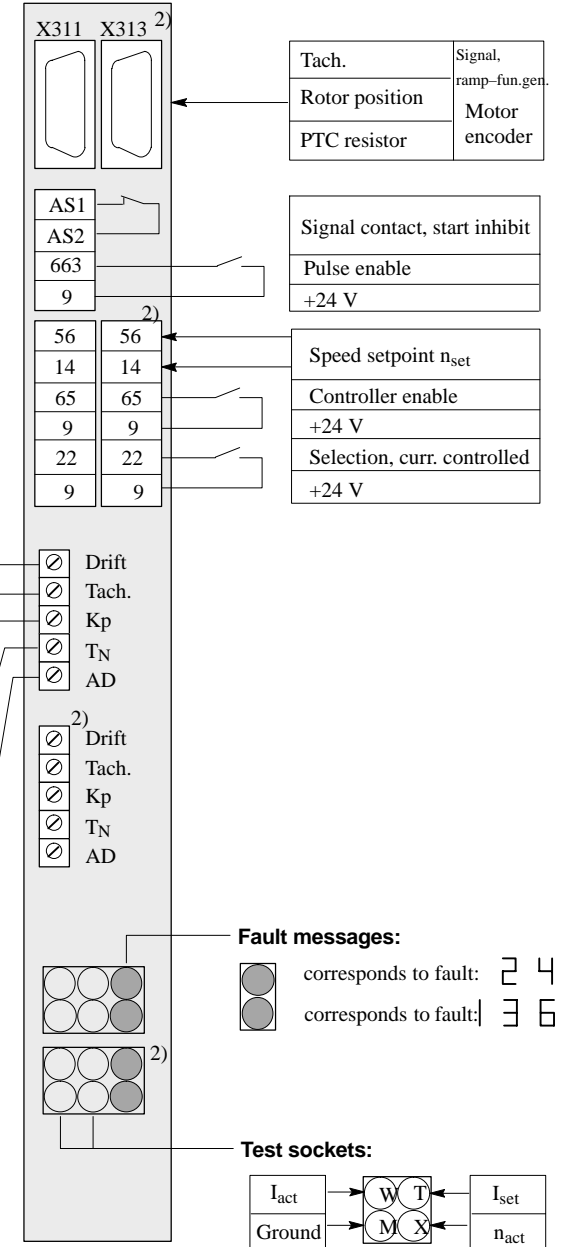

Adaptation T_N :
 Improves the dynamic response at low speeds. Activated by R34



1) optional, to change over closed-loop current controlled operation

2) Only for two-axis version

Setting elements, closed-loop resolver control

 = OFF
 = ON

Current controller

Axis 1: DIL switch S3
 Axis 2: DIL switch S6

Current actual value normalization α/β components [%]

Contacts
 1+2  α/β components
 100 | 70

Contacts	Current controller gain, Q/D axis														
3+7															
4+8															
5+9															
6+10															
	1 2 3 4 5 6 7.5 8.5 9.5 10.5 11.5 12.5 13.5 14.5 16														

Current setpoint limiting [%]

Axis 1: DIL switch S12 / contacts 1–4
 Axis 2: DIL switch S12 / contacts 5–8

Contacts	Current setpoint limiting							
1/5								
2/6								
3/7								
4/8								
	100 75 55 45 25 20 5							

Speed actual value normalization [RPM]

Axis 1: DIL switch S4 / contacts 1–4
 Axis 2: DIL switch S4 / contacts 5–8

Contacts	Speed actual value normalization			
1/5				
2/6				
3/7				
4/8				
	2000 3000 3000 6000			

These normalization settings are valid for standard resolver pole number $2p = 2$.
 Normalization settings for special pole numbers $2p = 4, 6, 8$ on request.

Monitoring logic

Axis 1: DIL switch S5 / contacts 1, 2, 5, 6, 7
 Axis 2: DIL switch S5 / contacts 3, 4, 5, 6, 8

	ON:	Contacts	OFF:
Inhibit integrator n controller		1/3	Integrator n contr. active
Inhibit integrator I contr. ²⁾		2/4	Integrator I contr. active ²⁾
Fault message		5	Ready signal
Master/slave operation		6	Standard operation
300 ms monitoring, T. 65		7/8	1 s monitoring, T. 65

Position processing

Axis 1: DIL switch S1
 Axis 2: DIL switch S2

Angular incremental encoder interface

	ON:	Contacts	OFF:
NC		5	NC
Phase seq., A in front of B		6	Phase seq., B in front of A ¹⁾
1024 pulses/revolution		7	512 pulses/revolution

Pole numbers

Contacts	Motor	Contacts	Resolver
1			
2			
	2p= 2 4 6 8		2p= 2 4 6 8

Zero offset [mechanical]

Axis 1: DIL switch S1 / contact 8
 DIL switch S11 / contacts 1–5
 Axis 2: DIL switch S2 / contact 8
 DIL switch S11 / contacts 6–10
 Total offset = Σ subsequent partial angle

Contacts	Partial angle						
S 1/2: 8							
S 11: 1/6							
2/7							
3/8							
4/9							
5/10							
	0 5.625 11.25 22.25 45 90 180						

- 1) For clockwise rotation
- 2) Only effective when selecting terminal 22

Short Reference Guide for SIMODRIVE 611 analog System – Feed module, closed-loop resolver control

Associated documentation:

Planning Guide 6SN1197-0AA00-0BP
 Start-up guide 6SN1197-0AA60-0BP

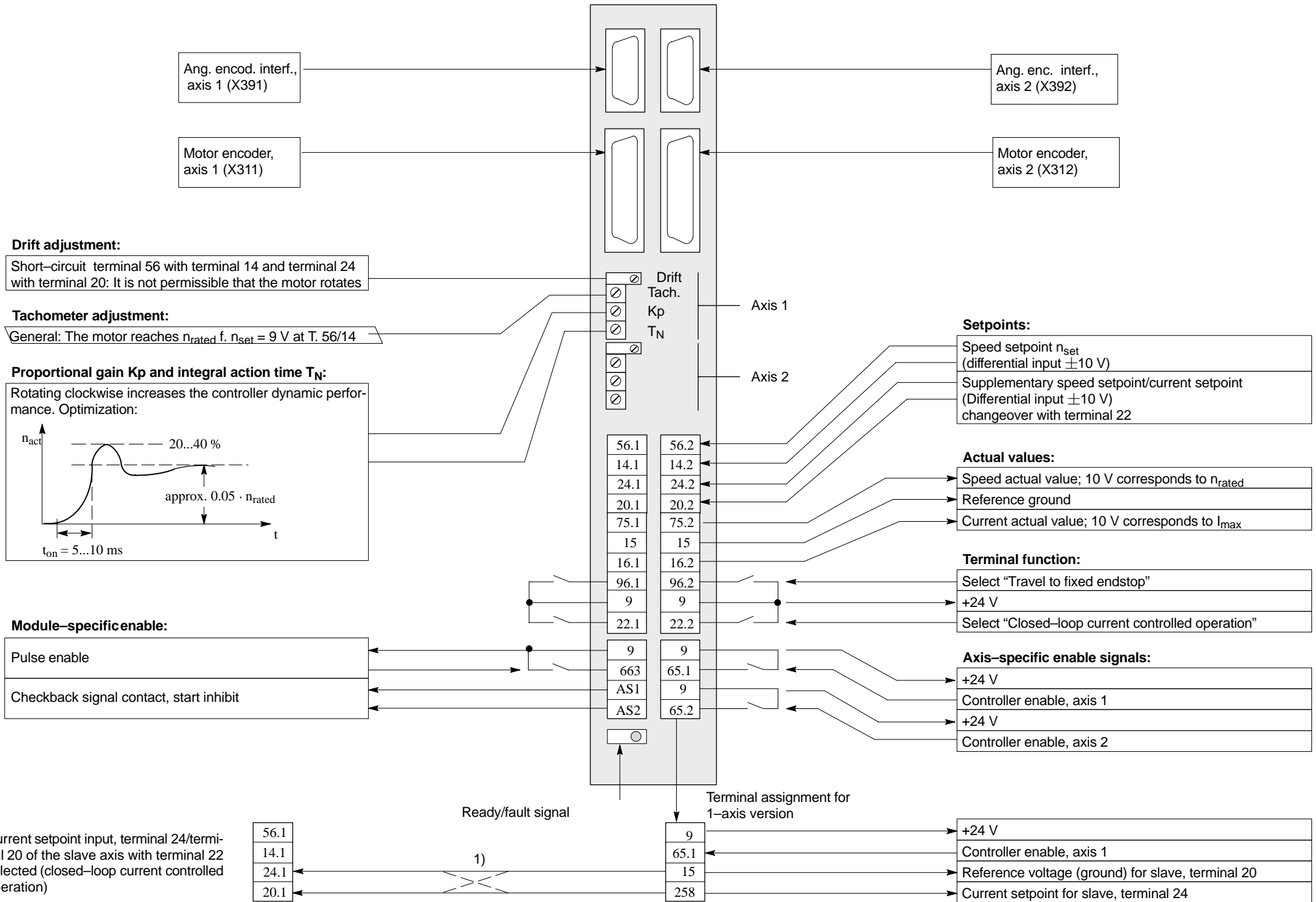

1) Connection is dependent on the required slave axis torque direction

Drive converter interfaces

Terminal function	Fct.No.	Input terminal 1)
2nd torque limit value	1	E1 (P-081)
Oscillation	2	E6 (P-086)
Reset fault memory (R)	3	E3 (P-083)
Open-loop torque controlled operation	4	E5 (P-085)
Star/delta operation	5	–
M19 operation	6	E4 (P-084)
Ramp-up time=0	7	E2 (P-082)
Integrator inhibit, speed controller	8	–
Gearbox stage bit 0	9	E7 (P-087)
Gearbox stage bit 1	10	E8 (P-088)
Gearbox stage bit 2	11	E9 (P-089)
Setpoint enable	16	–
Incremental positioning	22	–
Position reference values 1...2	23	–
C axis	24	–
Speed setpoint smoothing	25	–
Suppress F-11	26	–
Position reference values 3...4	27	–
Positioning on	28	–
Spindle re-synchronization	29	–
HPC axis	30	–
Slip monitoring	32	–

Relay function	Fct.No.	Relay output 1)
Ramp-up completed	2	A11 (P-241)
$ M_d < M_{dx}$	3	A21 (P-242)
$ n_{act} < n_{min}$	1	A31 (P-243)
$ n_{act} < n_x$	4	A41 (P-244)
Motor overtemperature, pre-alarm	5	A51 (P-245)
Drive converter overtemp., pre-alarm	6	–
Variable relay function 1	7	A61 (P-246)
Variable relay function 2	8	–
In position 1	9	–
In position 2	10	–
Relay, star operation	11	–
Relay, delta operation	12	–
$n_{act} = n_{set}$ (actual)	20	–

1) As supplied

Fault analysis

Fault signal	Fault
F-07	Data save on FEPR0M was not successful
F-08	Irretrievable data loss
F-09	Error, encoder system 1 (motor encoder)
F-10	Error, encoder system 2 (spindle encoder)
F-11	Speed controller is at its limit, speed actual value missing
F-14	Overtemperature, motor
F-15	Overtemperature, drive converter
F-16	Illegal power module code number
F-17	I_0 motor > I_{rated} power module
F-19	Temperature sensor (interrupted, short-circuit)
F-61	Max. motor frequency exceeded
F-79	Division interrupt
FP-01	Setpoint (reference value) > encoder pulse number
FP-02	Zero mark monitoring has responded
FP-03	Zero mark offset > encoder pulse number
FP-04	No valid zero mark

Faults

- after power ON** Operating display inactive
- min. two phases missing (NE module)
 - min. two input fuses have failed (NE module)
 - defective electronics power supply in the NE module
 - equipment bus connection, MSD module → NE module not inserted or defective
 - defective MSD module
 - defective EPROM/FEPR0M
 - firmware not loaded
- Controller enable** Motor rotates max. 30 RPM at $n_{set} > 30$ RPM or motor oscillates for $n_{set} < 30$ RPM
- incorrect motor rotating field, as the feeder cable is interchanged (interchange 2 phases)
 - excessive motor encoder pulse number entered
- Motor stationary for a speed setpoint not equal to zero
- oscillation function has been selected

Fault acknowledgement

Parameter key The parameter key is pressed with controller inhibit present. If the fault/error can be acknowledged, the system returns to the operator program.

Remote acknowledgement One of the following terminals is energized with the controller inhibited:

- terminal "R" at the NE or monitoring module
- terminal "Reset fault memory" at the MSD module

Powering-down Power-down the unit and approx. 2 s after the display goes dark, power-up again

Changing-over into the operator interface After pressing the  key, the operator program is returned to for approx. 1 minute; however, the fault/error is not acknowledged.

Short Reference Guide for SIMODRIVE 611 analog System – Main spindle module

Associated documentation:

Planning Guide 6SN1197-0AA00-0AP□
Start-up Guide 6SN1197-0AA60-0AP□

First steps

Operator and display elements

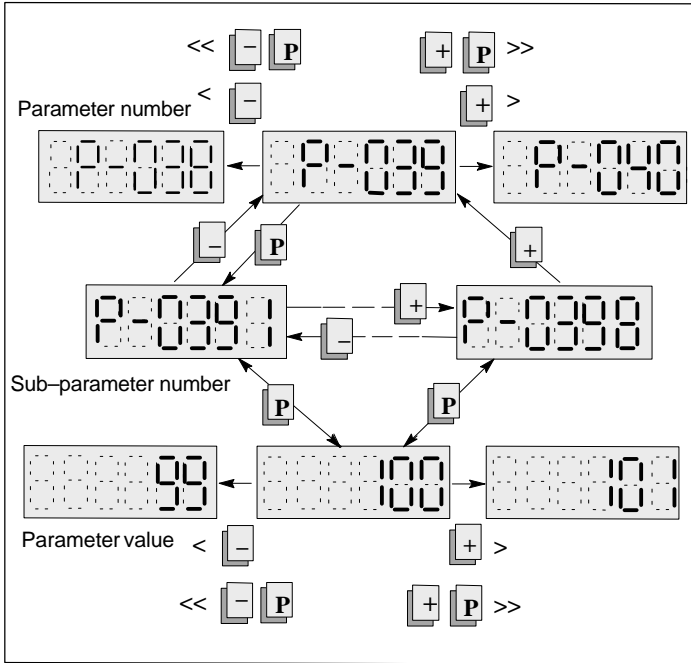

Start-up information

Start-up possibilities

- using the
- Operator control and display element
 - RS232C interface with an IBM/AT-compatible computer

Re-initialize drive converter (if necessary)

- Set P-051 to 4H
- Set P-097 to 0H
- Set P-052 to 1H and wait until P-052 resets itself to 0H
- Power-down the unit and approx. 2 s after the display has gone dark, power-up the unit again:

- P-095 must be re-displayed
- Initialize

Replace firmware (if required)

- Save the setting data (parameters)
- Replace the firmware using the start-up program
- Initialize with the pulses and controller inhibited
- The saved setting data are re-loaded
- Save the setting data in the drive-machine data memory

System configuration

Operating display

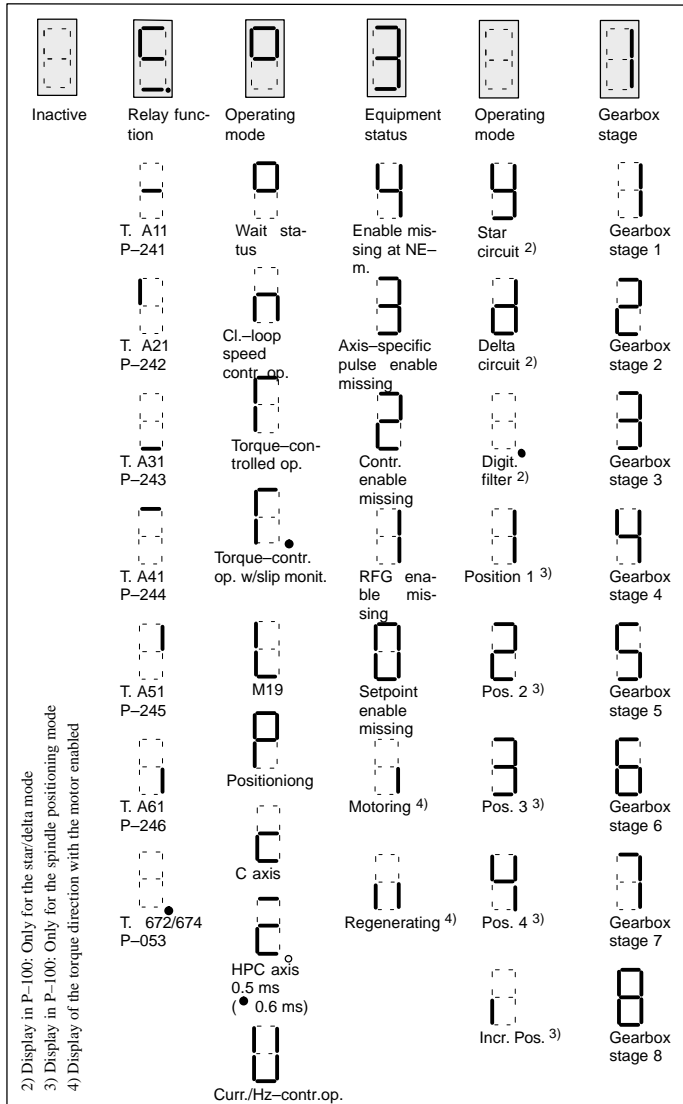

Firmware version and module expansion

Number	Display range	Description
(P-099)	0.00 ... 99.00	Firmware release
(P-150)	-	Board ID

Version coding: 0000 0000 0000 0000

- F00H Basic version
- 200H With additional input for spindle encoder
- 300H With output pulse encoder signals for external use

Drive converter interfaces

Connections

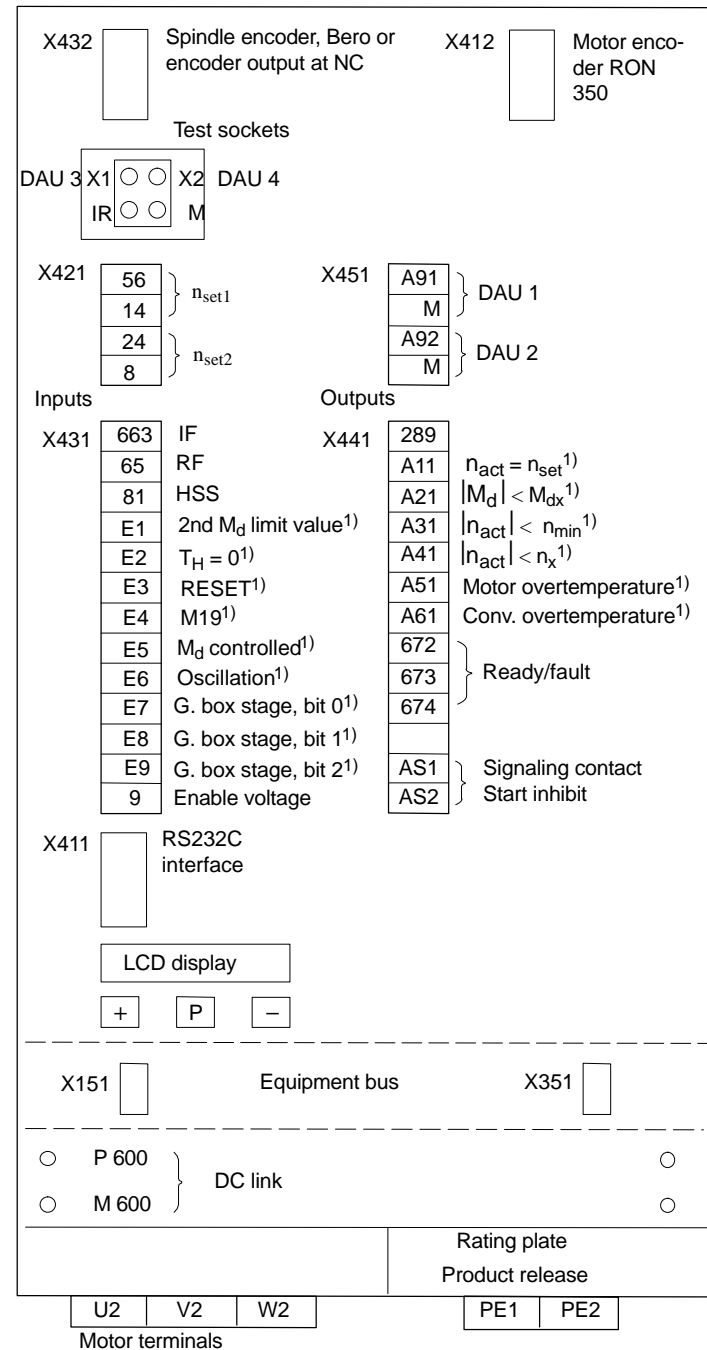

1) Freely-programmable terminals and relay functions when supplied

Drive converter interfaces

Terminal function	Fct.No.	Input terminal 1)
2nd torque limit	1	E1 (P-081)
Oscillation	2	–
Reset fault memory (R) (fault acknowledgement)	3	E3 (P-083)
Ramp-up time=0	7	E2 (P-082)
Gearbox stage	bit 0	9 E7 (P-087)
	bit 1	10 E8 (P-088)
	bit 2	11 E9 (P-089)
Clockwise/counter-clockwise	12	–
Ramp-function generator 2	13	–
Increase setpoint	14	–
Decrease setpoint	15	–
Setpoint enable	16	–
Fixed setpoint selection	bit 0	17 E4 (P-084)
	bit 1	18 E5 (P-085)
	bit 2	19 E6 (P-086)
	bit 3	24 –
Motor selection	bit 0	20 –
	bit 1	21 –

Relay function	Fct.No.	Relay output 1)
$ n_{act} < n_{min}$	1	A31 (P-243)
Ramp-up completed	2	A61 (P-246)
$ M_d < M_{dx}$	3	A21 (P-242)
$ n_{act} < n_x$	4	A41 (P-244)
I^2t pre-alarm	5	A51 (P-245)
Drive converter overtemp. pre-alarm	6	–
Variable relay function 1	7	–
Variable relay function 2	8	–
Motor 1 active	11	–
Motor 2 active	12	–
Motor 3 active	13	–
Motor 4 active	14	–
$n_{act}=n_{set}$	20	A11 (P-241)

1) As supplied

Fault analysis

Fault message	Fault
F-04	Fault, D/A conversion
F-05	Motor current = 0
F-07	Data save on FEPR0M not successful
F-08	Irretrievable data loss
F-11	Frequency setpoint > max. frequency
F-13	Field controller is at its max
F-14	Overtemperature, motor
F-15	Overtemperature, drive converter
F-16	Illegal power module code number
F-17	I_0 motor > I_{rated} power module
F-19	Temperature sensor, motor
F-51	Parameterizing error: Rated torque too high
F-52	Parameterizing error: Torque constant illegal
F-53	Parameterizing error: Rated motor current too low
F-60	Error for the automatic setting routine
F-90	Max. speed BERO exceeded

Faults

- after power ON** Operating display inactive
- min. two phases missing (NE module)
 - min. two input fuses have blown (NE module)
 - defective electronics power supply in the NE module
 - Equipment bus connection, IM module → NE module not inserted or defective
 - defective IM module
 - defective EPROM/FEPR0M
 - firmware not loaded

- Controller enable** Motor rotates counter-clockwise although the IM module outputs a clockwise rot. field or vice versa
- incorrect motor rotating field, as the feeder cable is interchanged, (interch. 2 ph. conn.)

Fault acknowledgement

- Parameter key** The parameter key is pressed with controller inhibit present. If the fault/error can be acknowledged, the system returns to the operator program.

- Remote acknowledgment** One of the following terminals is energized with the controller inhibited:
- terminal "R" at the NE or monitoring module
 - terminal "Reset fault memory" at the MSD module

- Powering-down** Power-down the unit and approx. 2 s after the display goes dark, power-up again

- Changing-over into the operator interface** After pressing the  key, the operator program is returned to for approx. 1 minute; however, the fault/error is not acknowledged.

Short Reference Guide for SIMODRIVE 611 analog System – Induction motor module

Associated documentation:

- | | |
|----------------|--------------------|
| Planning Guide | 6SN1197-0AA00-0BP□ |
| Start-up Guide | 6SN1197-0AA60-0BP□ |

First steps

Operator and display elements

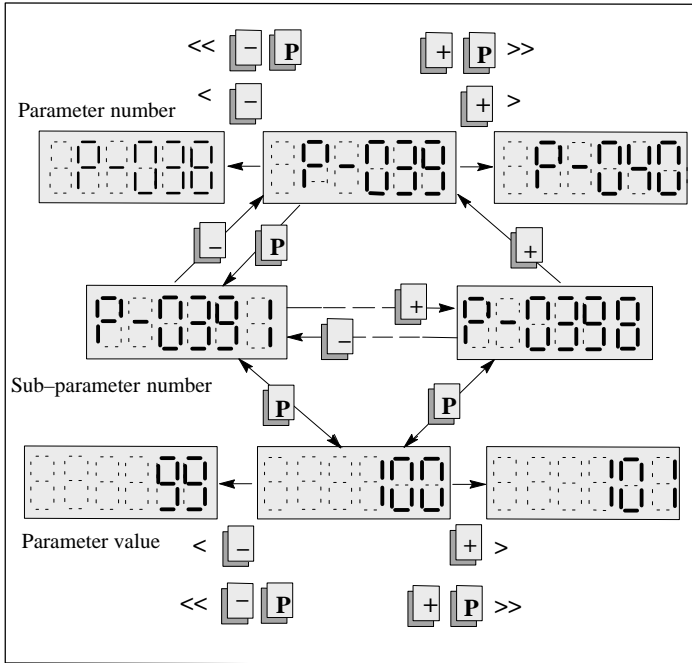

Start-up information

Start-up possibilities

- using
- Operator control and display elements
 - RS232C interface with an IBM/AT-compatible computer

Re-initialize drive converter (if necessary)

- Set P-051 to 4H
- Set P-097 to 0H
- Set P-052 to 1H and wait until P-052 resets itself to 0H
- Power-down the unit and approx. 2 s after the display has gone dark, power-up the unit again:

P-095 must be re-displayed

- Initialize
- Save the setting data (parameters)
- Replace the firmware using the start-up program
- Initialize with the pulses and controller inhibited
- The saved setting data is re-loaded
- Save the setting data in the drive-machine data memory

Replace firmware (if required)

System configuration

Operating display

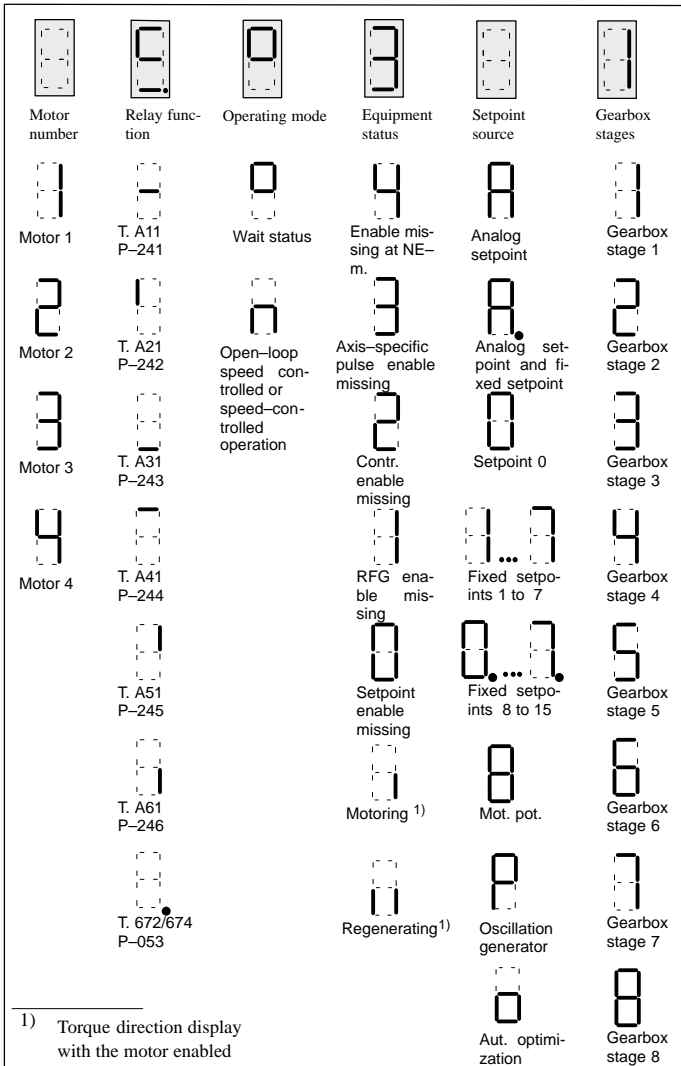

Firmware version and module expansion

Number	Display range	Description
(P-099)	0.00 ... 99.00	Firmware release

Drive converter interfaces

Connections

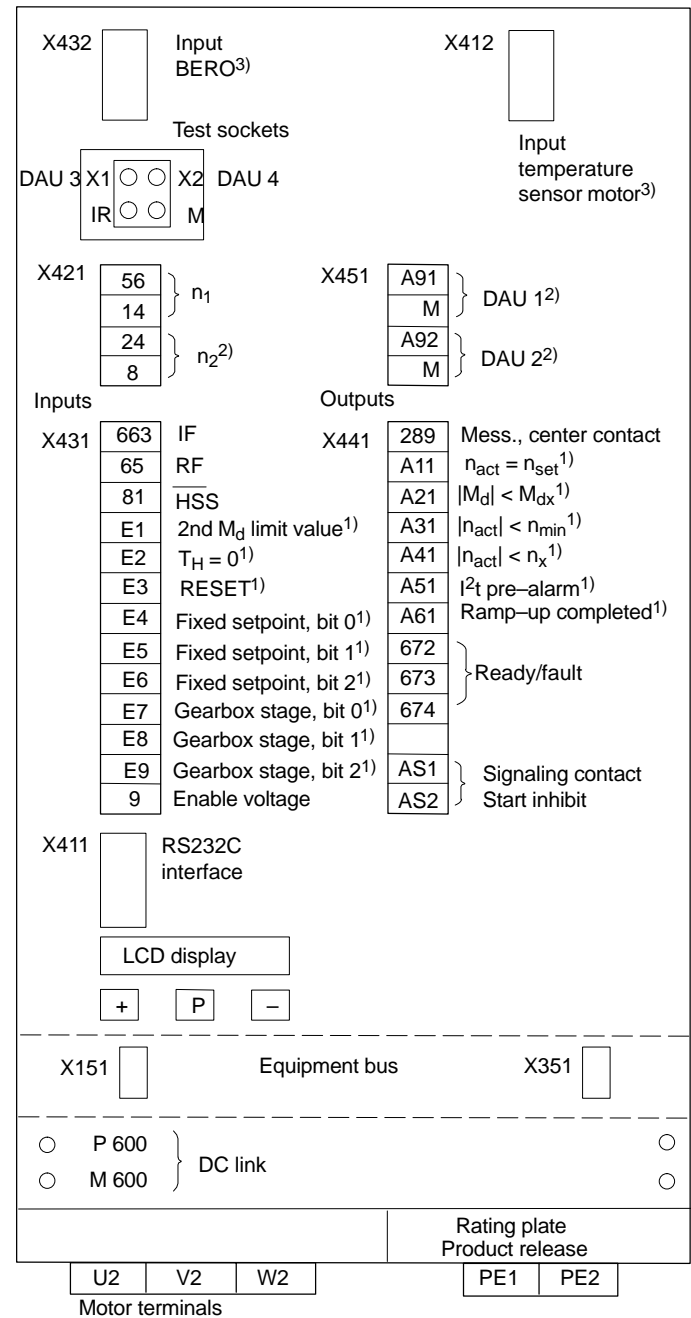

¹⁾ Freely-programmable terminals and relay functions as supplied
²⁾ Function not possible for Order No. [MLFB] 6SN1122-0BA11-0AA0
³⁾ Only for Order No. [MLFB] 6SN1122-0BA11-0AA1, otherwise assignment is not permissible

Overall Index

A

Accessories, ES/2-5
 Actual value normalization, VS/1-4
 Adaptation tables, VS/1-5, VR/1-5
 Address, RAM variable, HS/6-112
 Analog output
 fine normalization, HS/3-68
 M/Mrated display, HS/3-68
 nact display, HS/3-68
 P/Pmax display, HS/3-68
 parameterization DAU 1, DAU 2, HS/3-67
 Analog outputs, AM/3-48
 connection for analog displays, AM/3-50
 parameterization DAU, AM/3-49

B

Bit, HS/1-6
 Built-in motors, HS/6-102

C

C axis, HS/2-25, HS/2-31, HS/3-59
 C-axis operation, VS/5-39
 Cables, ES/2-6
 Changeover parameter for C-axis operation, VS/5-39
 Changeover speed, AM/2-18, AM/2-21
 Code numbers for power modules and standard motors, HS/6-99
 Commissioning
 Commissioning stages, VS/1-3
 Short commissioning, VS/1-3
 Standard commissioning, VS/1-3
 with the MSD option, VS/5-35
 Component side, VR/3-16, VR/9-30
 Connection overview
 connection diagram, HS/6-104
 relay terminals, HS/6-106
 star/delta changeover, HS/6-107
 terminals, HS/6-105
 Connections, HS/1-13, AM/1-14
 connecting diagram, AM/6-104
 relay terminals, AM/6-106
 terminals, AM/6-105
 Connector assignment, VR/9-33
 for Bero, HS/6-109
 motor encoder signal output, HS/6-110
 spindle encoder, HS/6-109
 Connectors, ES/2-5
 Control parameter, AM/1-10
 Current actual value normalization, VR/1-5

Current controller, HS/4-75, AM/4-57
 Current controller gain, VS/1-5, VR/1-5
 Current controller settings, VS/1-4, VR/1-5
 Current de-rating for inverter clock cycle frequencies > 3.2 kHz, HS/1-11
 Current setpoint limiting, VR/3-15
 Current/Hz control, AM/5-86

D

DAU, HS/3-67, AM/3-48
 DC link voltage, AM/2-16
 De-rating, AM/4-57
 De-rating for inverter clock cycle frequencies > 3.2 kHz, AM/4-58
 Diagnostic parameters, HS/5-81, AM/5-79
 Diagnostics, VS/8-47, VR/8-27, HS/5-77, AM/5-75
 Display, HS/2-25, HS/5-87, AM/2-22, AM/5-87
 Display elements, on the monitoring and NE modules, NE/2-7
 Display parameter, HS/2-25
 Display parameters, HS/5-77, AM/2-22
 Drift compensation, VS/2-23, VR/2-14

E

Electronic weight equalization, VS/3-30, VS/3-32, VR/3-17
 Encoder phase error correction, HS/2-27
 Equipment bus cable, ES/2-6

F

Fault, HS/5-92, AM/5-88
 acknowledgement, HS/5-87, AM/5-87
 display, HS/5-87, AM/5-87
 suppression, HS/5-87, AM/5-87
 Fault display, VS/8-48
 Fault message, VR/3-16, AM/5-88
 Field controller, AM/4-60, AM/4-70
 Field weakening range, AM/2-21
 Field-weakening range, AM/4-66
 Filter, HS/4-74
 Firmware release, AM/2-23
 Firmware version, HS/2-26
 Fixed setpoint, AM/3-38
 Flux adaptation, HS/2-52
 Functions via fixed values, VS/5-38

G

Gain Kp, VR/2-13
 Gain Kp with adaptation, VS/2-22
 Gearbox stage, HS/2-25, AM/2-22

H

Hexadecimal numbers, HS/1-6

I

I–component limiting, VS/2-23
 I²t limiting (from FW 3.1), HS/2-54
 Initialization, AM/2-16, AM/2-21
 special motors, HS/2-17
 standard motors, HS/2-15
 star/delta motors, HS/2-21
 Input terminals, HS/3-58, AM/3-40
 Integral action time limiting, VR/3-16, VR/3-18
 Integral action time with adaptation, VS/2-21
 Integral action time/Speed controller, VR/2-14
 Integrator inhibit, VR/3-16
 Interfaces, AM/6-107
 Inverter clock cycle frequency, HS/4-76, AM/4-57
 Inverter clock frequency, HS/3-59

K

K_p gain without adaptation, VS/2-19

L

Layout diagram MSD option board, VS/9-53
 Layout diagram, component side, VR/9-30
 Layout diagram, parameter board, VS/9-54
 Layout diagram, solder side, VR/9-31
 Layout diagram, speed control loop, VS/9-56
 Layout diagram, standard interface, VS/9-55
 LED display, VR/8-27
 Limit value stages, VS/5-37
 Limits, AM/4-62

M

M19, HS/2-25, HS/2-30
 Magnetizing reactance, AM/2-18, AM/4-72
 Manual optimization, AM/4-65
 Master/slave, VS/3-29, VR/3-16, VR/3-17
 Master/slave operation, HS/2-44
 Max. speed monitoring, AM/2-23
 Maximum current limiting (from FW 3.1), HS/2-54
 Measured value displays, HS/5-77, AM/5-75
 Minimum speed, HS/3-57
 steady–state, AM/4-63
 Minimum/maximum value memory, AM/5-83
 Mode, HS/2-25

Mode of operation

 master speed controlled, VR/3-16, VR/3-18
 slave current controlled, VR/3-16, VR/3-17,
 VR/3-18

Motion of operation, Master speed controlled,
 VR/3-17

Module ID, HS/2-26

Moment of inertia, AM/2-17, AM/4-56, AM/6-98

Monitor function, AM/2-36

Motor changeover, AM/2-32

Motor code number, HS/6-99

Motor data set, HS/2-18, HS/2-22, AM/2-17

Motor rotor resistance, AM/4-74

Motor rotor resistance, cold, AM/2-17

Motor temperature emulation, AM/2-25

Motor temperature monitoring, HS/2-29

Motorized potentiometer, AM/3-37

MSD option board, VS/9-53

Multi–motor operation, AM/2-27

N

No–load current, AM/4-71

No–load motor current, AM/4-59, AM/4-71

Normalization of the M/P display, VS/5-37

O

Open–loop controlled range, AM/4-61

Open–loop torque controlled mode, HS/2-44

 function description, HS/2-44

 master drive, HS/2-44

 slave drive, HS/2-44, HS/2-45

 torque setpoint, HS/2-44, HS/2-45

Operating display, VS/8-47, HS/2-25, AM/2-22

Operating mode, AM/2-22

Operator and display elements, AM/1-9

Operator control and display elements, HS/1-8

Optimization, open–loop controlled range,
 AM/4-61

Orientated spindle stop, HS/2-30

Oscillation mode, HS/2-29

Oscillation operation, AM/2-26

Output terminals, HS/3-61, AM/3-43

P

Parallel operation, AM/2-27

Parameter
 attributes, AM/1-5
 list, AM/1-5
 number, AM/1-9
 Parameter board, VS/9-54
 Parameter list, HS/6-113, AM/6-109
 Parameter set changeover, AM/2-32
 Parameters
 attributes, HS/1-5
 gearbox–stage dependent, HS/1-8
 list, HS/1-5
 number, HS/1-5, HS/1-8
 setting range, HS/1-5, HS/1-6, AM/1-5,
 AM/1-6
 sub–parameter number, HS/1-8, AM/1-9
 transferring into the FEPRM, HS/1-9
 value, HS/1-8, AM/1-9
 write protection, HS/1-9, AM/1-6
 write–protection, HS/1-6
 Phase sequence of tracks A, B (WSG), VR/3-15
 Pin assignment X311 and X313, VS/9-57
 Pole numbers, VR/1-3
 Position processing, VR/3-15
 Power module code number, HS/6-99, AM/2-16
 Powering–up, VR/7-25
 Proportional gain Kp, VR/2-13
 Proportional gain Kp with adaptation, VS/2-22
 Proportional gain kp without adaptation, VS/2-19
 Pulse number, angular encoder interface,
 VR/3-15

R

RAM variable, AM/6-108
 RAM variable addresses, AM/6-108
 RAM variables, HS/6-112
 Ramp–function generator, HS/4-70, AM/4-54
 tracking, AM/4-54
 Ramp–up time, VS/5-35
 Rating plate, AM/1-14
 Re–initializing drive converter, AM/1-7
 Re–initializing the drive converter, HS/1-7
 Relay function, AM/2-22
 permanently–connected, AM/3-43
 Relay functions, HS/2-25
 control word, signals, HS/3-63, AM/3-46
 freely–programmable, HS/3-61, AM/3-44
 parameterizable signals, AM/3-46
 permanently–wired, HS/3-61
 signals which can be parameterized, HS/3-63
 variable, HS/3-64, AM/3-47
 Replacing components, HS/1-7, AM/1-8
 Replacing firmware, HS/1-7
 Replacing modules, HS/1-7, AM/1-8
 Replacing the firmware, AM/1-7

RS232C interface, AM/1-7, AM/1-14
 Run–up time, NE/2-11

S

Series machines, HS/1-7, AM/1-8
 Service and diagnostics, VS/8-47, VR/8-27
 Setpoint interfaces, VR/4-19
 Setpoint priority, AM/3-39
 Setpoint source, AM/2-22
 Setting and monitoring data, HS/6-113, AM/6-109
 Setting data, HS/1-12, AM/1-13
 Setting elements
 with standard interface, VS/3-25, VR/4-19,
 VR/4-20
 with user–friendly interface, VS/3-29
 Setting the integral action time, VR/2-14
 Settings via fixed values, VS/5-38
 Shutdown without reverse rotation, AM/4-64
 Shutdown, without reverse rotation, AM/3-40
 Slip monitoring, HS/2-46, HS/3-59
 Smoothing
 speed actual value, HS/4-70, HS/4-76
 speed setpoint, HS/3-59, HS/4-69
 torque setpoint, HS/4-73
 Smoothing functions, VR/3-16
 Solder side, VR/3-16, VR/9-31
 Special motors
 flux setpoint characteristic, HS/2-19
 initialization, HS/2-17
 main field inductance-characteristic, HS/2-19
 motor data set, HS/2-18
 Speed actual value normalization, VR/1-4
 Speed actual value smoothing, HS/4-70
 Speed control loop, VS/9-56
 Speed controller
 adaptation, HS/4-72, AM/4-55
 gain, HS/4-71, AM/4-55
 integral action time, HS/4-71, AM/4-55
 Speed controller clock cycle, AM/4-56
 Speed range suppression, AM/4-64
 Speed ranges, AM/4-63
 Speed setpoint interface, HS/3-55
 channel selection, HS/3-55
 minimum speed, HS/3-57
 normalization, HS/3-56
 smoothing, HS/3-59
 unipolar input, HS/3-56
 Speed setpoint interfaces, AM/3-37
 channel selection, AM/3-37
 setpoint priority, AM/3-39
 Speed setpoint smoothing, HS/4-69
 Speed setting value, HS/2-27
 Speed setting values, AM/2-23

Spindle positioning, HS/2-31
 brief commissioning, HS/2-43
 diagnostic parameters, HS/2-42
 function description, HS/2-31
 position controller, HS/2-37
 Position reference value, HS/2-34
 position reference value, HS/2-33, HS/2-35,
 HS/2-41, HS/2-42, HS/3-59
 relay signal, HS/2-34
 search speed, HS/2-32, HS/2-33, HS/2-39,
 HS/2-41
 zero mark, HS/2-32, HS/2-34, HS/2-35,
 HS/2-36, HS/2-39, HS/2-42, HS/3-59
 zero pulse, HS/2-33, HS/2-38, HS/2-43
Standard applications, HS/2-25, HS/2-27, AM/1-4,
 AM/2-22, AM/2-26
 setting parameters, AM/2-23
Standard commissioning, VS/1-3
Standard interface, VS/1-4, VS/9-55
Standard motors, initialization, HS/2-15
Standard settings, VS/1-3, VR/1-3
Standard start-up, VR/1-3
Star/delta motors, HS/6-101
 flux setpoint characteristic, HS/2-23
 initialization, HS/2-21
 main field inductance-characteristic, HS/2-23
 motor changeover, HS/2-24
 motor data set, HS/2-22
Start-up
 instructions, HS/1-7, AM/1-7
 new start-up, AM/6-92
 possibilities, HS/1-7, AM/1-7
 short start-up, VR/1-3
 standard start-up, VR/1-3
 start-up stages, VR-ii
Status display
 active functions 1, AM/5-77
 active functions 2, AM/5-78
 active terminal function, HS/5-79, HS/5-80
 digital inputs, HS/5-78, AM/5-76
Steady-state minimum speed, AM/4-63
Sub-parameter number, HS/1-8, AM/1-9
Supplementary setpoint, VS/3-29

T

Tachometer adaptation, VS/1-4
Tachometer calibration, VS/2-18, VR/2-12
Terminal function
 assignment, HS/3-59, AM/3-41
 freely-programmable, HS/3-59, AM/3-41
 permanently-connected, AM/3-40
 permanently-wired, HS/3-58
Terminals, VR/9-29
Test sockets, VR/8-27, VR/8-28, HS/5-82,
 AM/5-80
Test sockets and display elements
 standard interface, VS/8-49
 user-friendly interface, VS/8-47
Timer, VS/3-29, VR/3-16
TN (integral action time), VR/2-14
Torque limit value, HS/2-28, AM/2-24
Torque limiting, VS/5-36
Torque setpoint smoothing, HS/4-73
Total moment of inertia, AM/4-56
Transient recorder function, HS/5-84, AM/5-84
Travel to fixed endstop, VS/3-29
Troubleshooting, VS/8-50

U

Uncontrolled infeed, HS/2-16
Unit status, HS/2-25, AM/2-22
User-friendly interface, VS/1-4

W

Water-cooled motors, HS/6-101
Weight equalization, VS/3-30

Z

Zero offset, VR/3-15

To
 SIEMENS AG
 A&D MC BMS
 Postfach 3180
 D-91050 Erlangen
 (Tel. 0180 / 525 – 8008 / 5009 [Hotline]
 Fax 09131 / 98 – 1145
 email: motioncontrol.docu@erlf.siemens.de)

Recommendations	
Corrections	
for documentation:	
SIMODRIVE 611 analog Transistor PWM Inverters for AC Feed Drives and AC Main Spindle Drives	
Manufacturer/Service Documentation	
Start-Up Guide	
Order No.:	6SN1197-0AA60-0BP5
Edition:	10.00
If you should come across any printing errors in this document, please let us know using this form. We would also be grateful for any recommendations and suggestions.	

From	
Name _____	
Company address/Dept. _____	
Street _____	
Postal code:	City:
Telephone:	/
Telefax:	/

Recommendations and/or corrections